

FLOS

COLLECTION CATALOGUE 2024

ITALIANO / ENGLISH

FEATURED PRODUCTS	SOPHISTICATED COMMODITIES	SOFT ARCHITECTURE
14 • MY CIRCUIT	566 LED CURTAIN	596 WALL RUPTURE
38 BELT	568 IN-FINITY	598 SOFTPROFILE
60 INFRA-STRUCTURE	572 CIRCLE OF LIGHT	600 JUNCOS
80 INFRA-STRUCTURE	573 LIGHT CUT MINI	602 SOFT SPUN
EPISODE 2	574 SUPER FLAT	604 ABAJOURD'HUI
100 GUSTAVE	576 LIGHT BELL	606 USO
118 • EMI	578 THIN LED	608 USO COVE LIGHTING
148 OBLIQUE	580 LIGHT SUPPLY	610 G-O IN
170 DIVERSION	582 JOHNNY	612 TEARDROP
194 ZERO TRACK &	586 WAN	614 ROUND, SQUARE &
• ZERO TRACK PRO	588 G-O	VERTICAL LIGHT
222 THE MICRO RUNNING	588 THEBLOCKOFLIGHT	
MAGNET		
248 • THE RUNNING MAGNET		
278 THE TRACKING MAGNET		
304 • THE TRACKING POWER EVO		
320 THE FAST TRACK		
334 • WORKMATES		
360 LIGHT SHADOW		
382 • LIGHT SHADOW		
DOTS & PRO		
406 ECLECTIC		
420 • LIGHT SHADOW SPOT		
434 CAMERA		
450 SUPER LINE &		
SUPERLINE PRO		
468 KAP		
502 C1		
516 FIND ME		
530 UT		
548 BON JOUR		
556 FORT KNOX		

- Novità/New product

L'obiettivo di Flos è quello di offrire sempre la tecnologia più affidabile sul mercato, controllando costantemente i nostri prodotti e aggiornandoli al passo con le evoluzioni tecnologiche quando queste apportino vantaggi ai nostri partner e clienti. Quindi, in caso di necessità di informazioni tecniche e delle ultime info di prodotto, vi invitiamo a visitare la sezione di prodotto o il nostro sito web flos.com, che viene aggiornato quotidianamente.

Flos aim is to offer always the best reliable technology available, constantly reviewing our products and upgrading them as soon as technologic evolutions offers benefits for our partners and clients. Thus, when you need technical details and the most recent product information, please browse the product section of our daily updated website flos.com.



MY CIRCUIT
14



OBLIQUE
OBLIQUE FLOOR
148

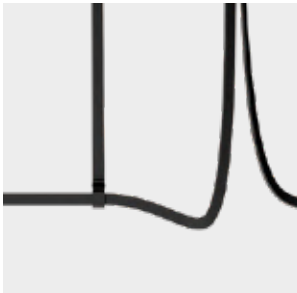

BELT
38

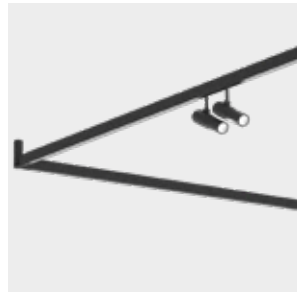

DIVERSION
170

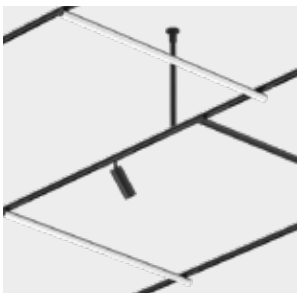

INFRA-STRUCTURE
60

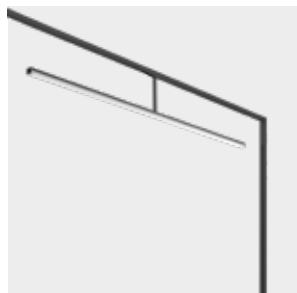

ZERO TRACK
ZERO TRACK PRO
194



INFRA-STRUCTURE
Episode 2
80



THE MICRO RUNNING
MAGNET
222



GUSTAVE
100



THE RUNNING MAGNET
248



EMI
118



THE TRACKING MAGNET
278

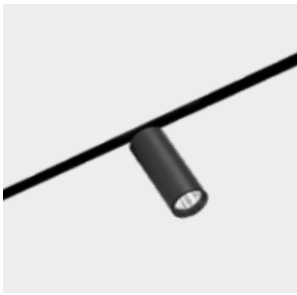

THE TRACKING POWER
EVO
304



LIGHT SHADOW SPOT
420



THE FAST TRACK
320

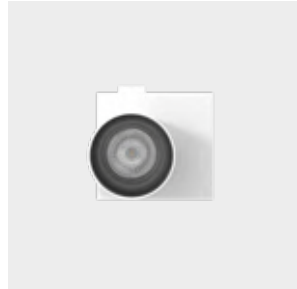

CAMERA
434



WORKMATES
334

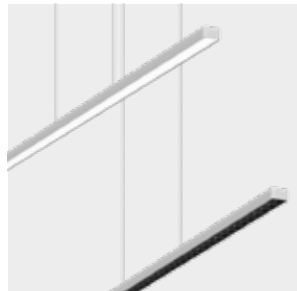

SUPER LINE
SUPER LINE PRO
450



LIGHT SHADOW
360



KAP
EASY KAP
KAP SURFACE
KAP SUSPENSION
468



LIGHT SHADOW PRO
LIGHT SHADOW DOTS
382

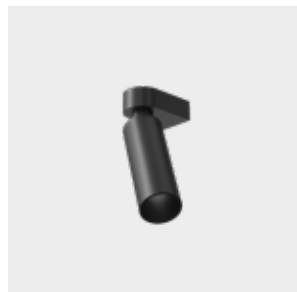

C1
502

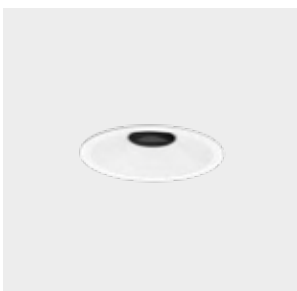

ECLECTIC
406

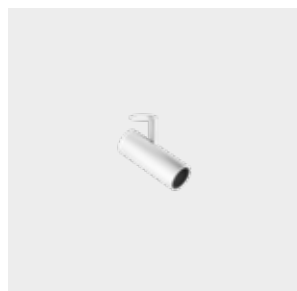

FIND ME
516



UT SPOT
UT DOWNLIGHT
UT PRO SURFACE
530



LIGHT CUT MINI
573

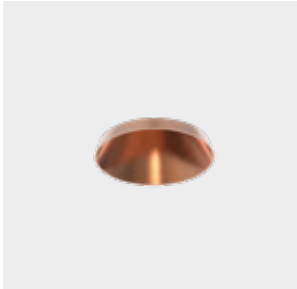

BON JOUR
548



SUPER FLAT
574



FORT KNOX WALL
FORT KNOX WALL MINI
556

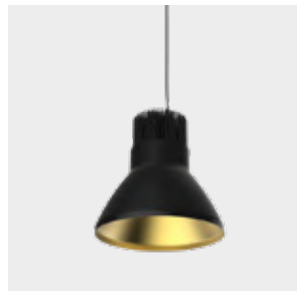

LIGHT BELL
576



LED CURTAIN
566



THIN LED
578



IN-FINITY
568



LIGHT SUPPLY
580



CIRCLE OF LIGHT
572



JOHNNY
582

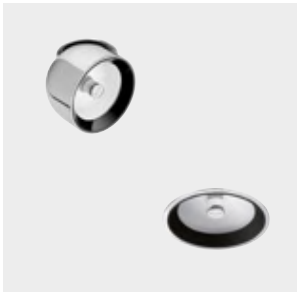

WAN SPOT
WAN DOWNLIGHT
586



SOFT SPUN
602

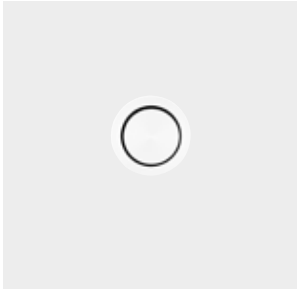

G-O
588



ABAJOURD'HUI
604

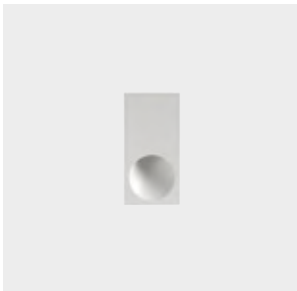

THEBLOCKOFLIGHT
588



USO
606



WALL RUPTURE
596



USO COVE LIGHTING
608



SOFTPROFILE
598



G-O IN
610



JUNCOS
600



TEARDROP
612



ROUND, SQUARE &
VERTICAL LIGHT
614

My Circuit, Belt, Infra-Structure, Infra-Structure
Episode 2, Gustave, EMI, Oblique, Diversion,
Zero Track, Zero Track Pro, The Micro Running
Magnet, The Running Magnet, The Tracking
Magnet, The Tracking Power EVO, The Fast
Track, Workmates, Light Shadow, Light Shadow
Dots, Light Shadow Pro, Eclectic, Light Shadow
Spot, Camera, Super Line, Super Line Pro, Kap,
C1, Find Me, UT, Bon Jour, Fort Knox Wall.

FEATURED PRODUCTS

My Circuit, disegnata da Michael Anastassiades, è la prima struttura per apparecchi d'illuminazione da interni composta da una struttura flessibile che permette disegnare sul soffitto dei tracciati continui e completamente liberi, combinando linee rette con curve di differente raggio.

My Circuit, designed by Michael Anastassiades, is the first structure for indoor lighting consisting of a flexible profile that allows the drawing of continuous and completely free paths on the ceiling, combining linear sections with curves of various radii.

MY CIRCUIT

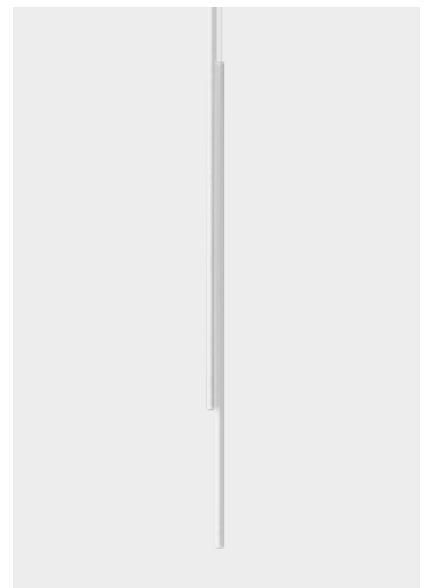
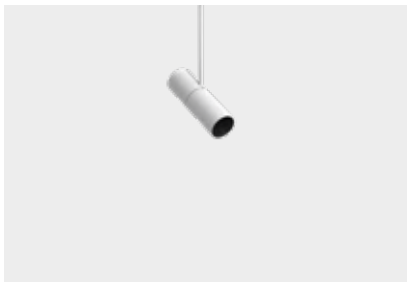

Per progettare una configurazione, occorre selezionare e combinare in maniera consequenziale i moduli di fissaggio che verranno uniti tra loro fino a disegnare una spina dorsale da fissare al soffitto e che andrà a determinare la forma di My Circuit. Una volta completata la configurazione e dopo averla montata a soffitto, avremo ottenuto la lunghezza totale del percorso della spina dorsale. Su di essa verrà montato il profilo flessibile. Infine, sarà la volta di accessori e apparecchi di illuminazione.

When designing a layout, the fixing modules to be joined together must be chosen and combined consecutively until a central spine is drawn up that is mounted on the ceiling and defines the shape of My Circuit.

Once this layout is completed and installed on the ceiling, you obtain the total length of the central spine. The flexible profile is then installed onto this. Finally come the accessories and luminaires.

- 1 POWER SUPPLY END
- 2 FIXATION STRAIGHT
- 3 FIXATION CURVES
- 4 MY CIRCUIT PROFILE
- 5 POWER SUPPLY MIDDLE
- 6 MIDDLE CAP
- 7 SPOTS
- 8 SUSPENSION FIXTURES
- 9 END CAP

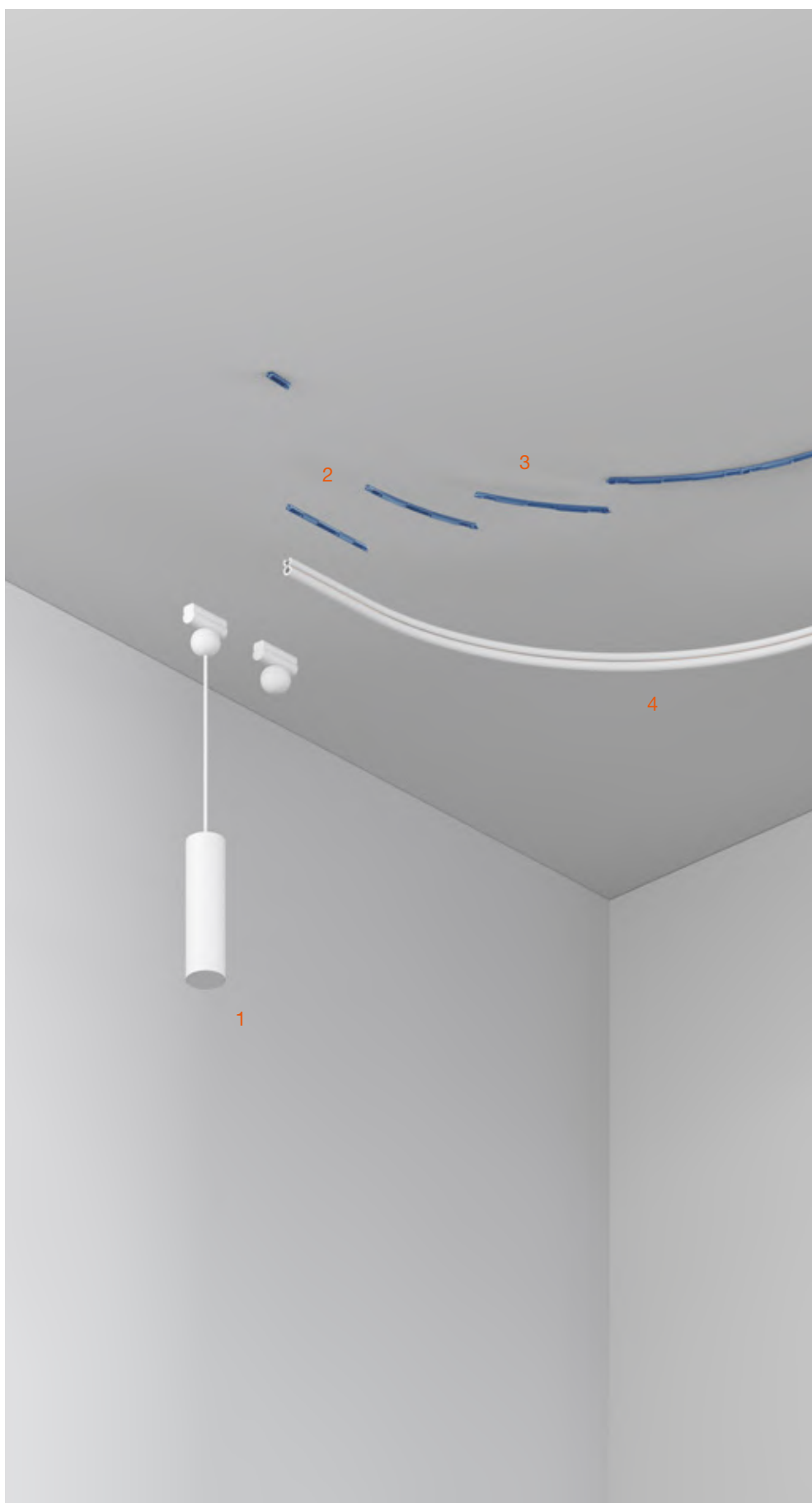

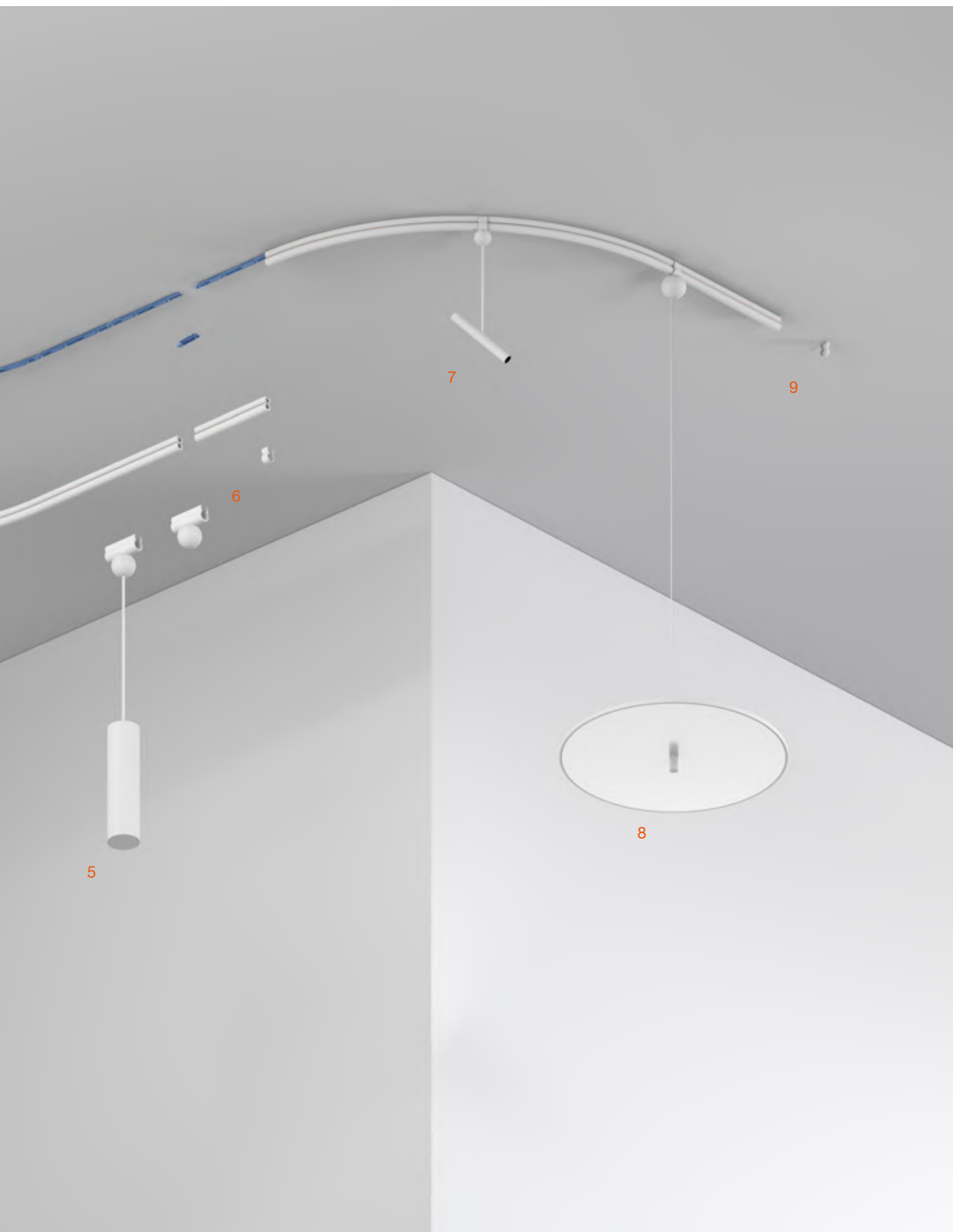

My Circuit offre un approccio funzionale all'illuminazione decorativa. My Circuit è un sistema a soffitto flessibile che trae ispirazione dalle piste elettriche per macchinine dell'infanzia di Anastassiades, i cui elementi sono utilizzati per ridisegnare un'interpretazione minimalista e contemporanea di motivi in gesso presenti sui soffitti delle abitazioni d'epoca.

My Circuit offers a functional approach to decorative lighting. A flexible ceiling system, My Circuit is inspired by electric slot cars from Anastassiades' childhood, whose elements are used to redesign a contemporary, minimalist take on plaster motifs found on the ceiling of period homes.









SPOTS

My Circuit presenta due famiglie di faretti: gli eleganti My Spots, dalla mente del designer Michael Anastassiades, e i faretti My Light Shadow Spots che vantano le ben note prestazioni tecniche della famiglia di prodotti Light Shadow.

My Circuit comes with two projector families: the elegant My Spots, designed by Michael Anastassiades, and the My Light Shadow Spots, with the well-known technical features of the Light Shadow family of products.

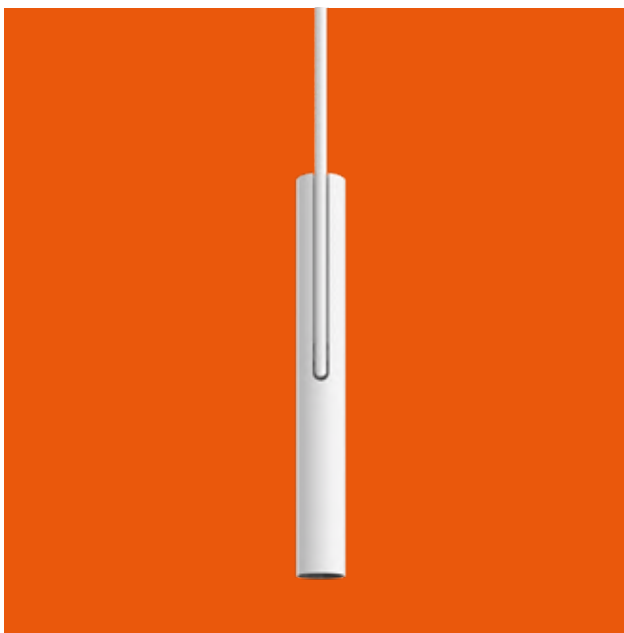

MY DISC & MY LINES

My Disc è una lampada slanciata con emissione Down per un'illuminazione verso il basso e d'atmosfera.

Grazie a My Lines è possibile sospendere un apparecchio di illuminazione da My Circuit che, sul piano funzionale, funge nello spazio da lampada da terra.

My Disc is a slim Down emission luminaire for downlight and ambient illumination.

My Lines allows you to suspend a luminaire from My Circuit, which in functional terms acts as a floor lamp in the space.

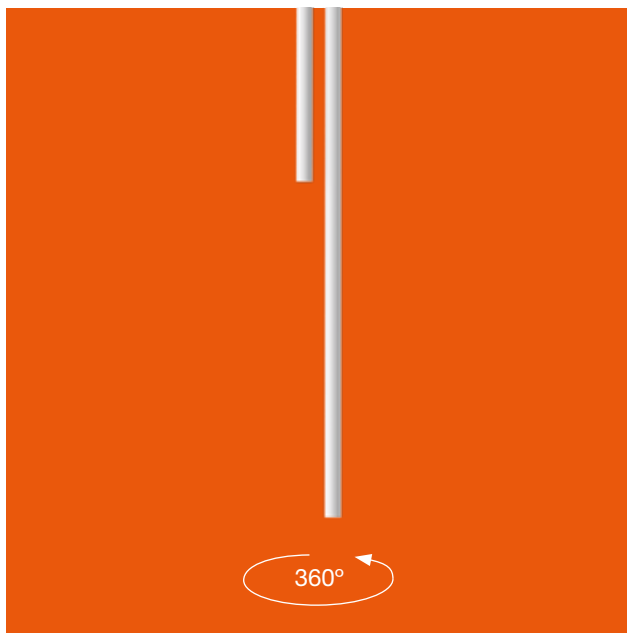

MY DOME & MY SPHERE

My Dome offre la classica sospensione per illuminazione downlight reinterpretata dalla poesia di Michael Anastassiades.

My Sphere è la soluzione di My Circuit dotata di un aspetto estetico più prominente grazie alla sua forma e all'emissione di luce onnidirezionale.

My Dome offers the classic suspension piece for downlight illumination reinterpreted with the poetry of Michael Anastassiades.

My Sphere is the My Circuit solution with an aesthetic presence characterised by its form and omnidirectional light emission.

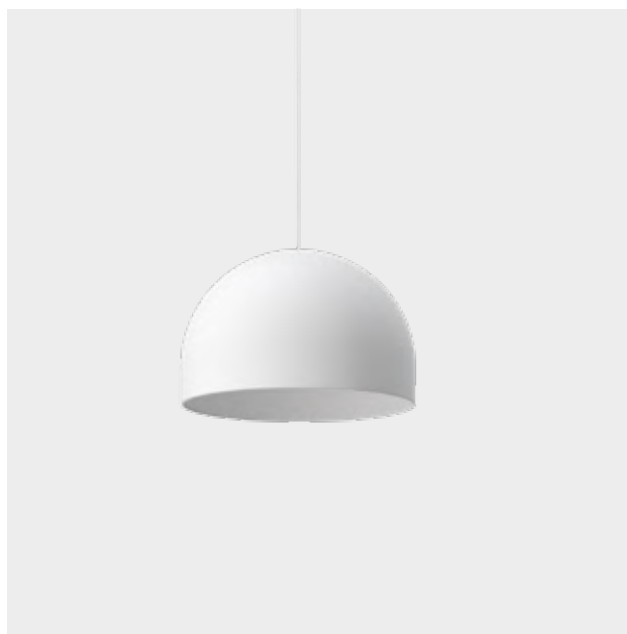







I fissaggi di My Circuit sono concatenati come sezioni di una pista di macchinine giocattolo. Unendo le sezioni necessarie, andrà a delinearsi il percorso progettato. L'innovativo binario flessibile My Circuit si inserisce nei fissaggi come spina dorsale. Una "sorta" di anima interna che donerà al profilo modulabile la sua forma definitiva.

My Circuit fixations are concatenated like track sections on a Scalextric racing car set. The union of the necessary sections draws the designed route.

The innovative My Circuit flexible track is inserted into the fixations like a central spine. A sort of internal 'soul' that gives the modellable profile its final form.



Gli apparecchi di illuminazione My Circuit presentano adattatori progettati specificatamente per essere raccordate al binario flessibile abbracciandolo dall'esterno.

My Circuit luminaires have adapters specially designed to link with the flexible track by grasping it from the outside.

FLEXIBLE PROFILE



L: 8000 / 15000 / 20000









Il rivoluzionario binario flessibile di Michael Anastassiades rappresenta un nuovo approccio all'illuminazione di uno spazio, fungendo da strumento architettonico che offre una combinazione di illuminazione d'atmosfera diffusa e sofisticata illuminazione d'accento.

Michael Anastassiades' revolutionary flexible track offers a new approach to illuminating a space, serving as an architectural tool that offers a combination of diffused ambient lighting and sophisticated accent lighting.

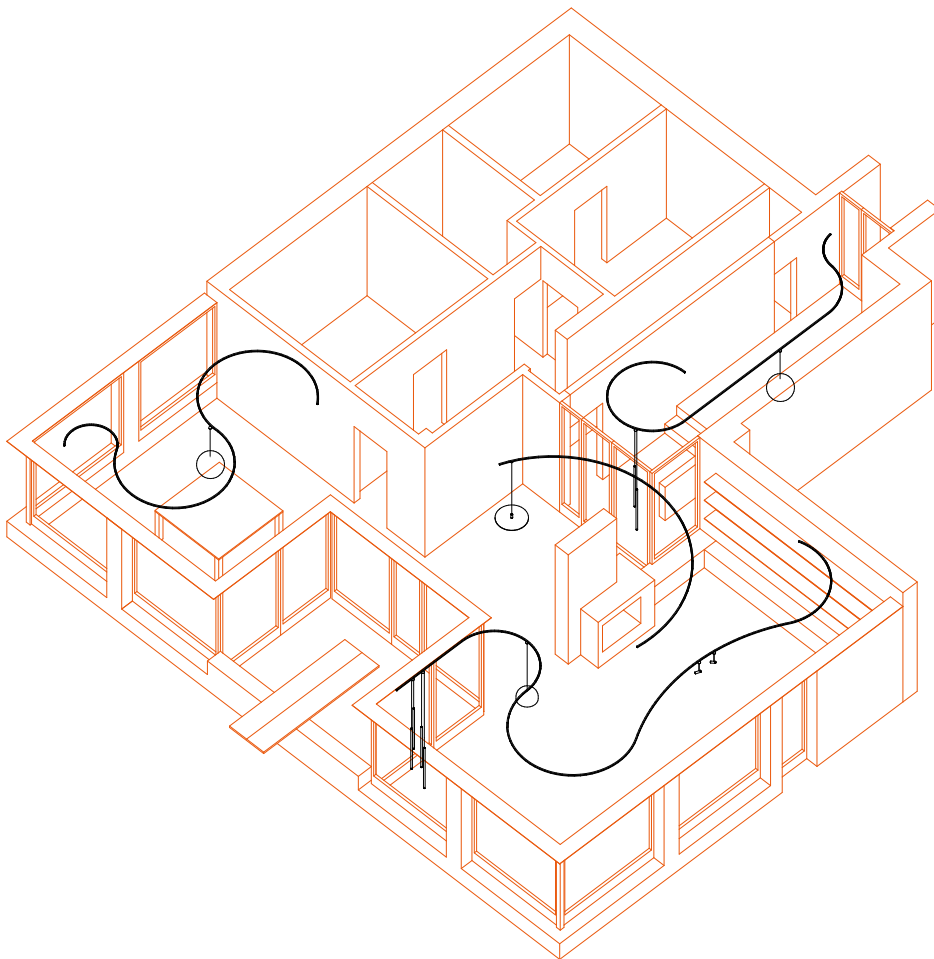

INFINITI LAYOUT

Il sinuoso binario da soffitto permette di agganciare una gamma di opzioni di illuminazione tra cui farette decorativi ad alte prestazioni, sospensioni a cupola o dischi circolari e lampade sospese terra-soffitto, tutti permeati dall'approccio poetico alla forma di Anastassiades. Apparentemente sono infinite le soluzioni che My Circuit può offrire, grazie all'approccio ludico alla modularità del suo binario e al ricco ventaglio di elementi di illuminazione che possono esaltarne la presenza o ritrarlo come uno strumento funzionale e discreto.

L'estrema semplicità degli elementi e la versatilità con cui possono essere combinati permette di liberare la creatività del progetto, dando vita a innumerevoli soluzioni.

ENDLESS LAYOUTS

Connecting to the sinuous ceiling track is a series of illuminating options that include high performance and decorative spotlights, pendants shaped like circular domes or discs, and suspended floor to ceiling lamps, all defined by Anastassiades' poetic approach to form.

There is seemingly no end to what My Circuit can achieve, thanks to the playful approach to modularity of its track and its rich portfolio of lighting objects that can enhance its presence or leave it as a functional, discreet tool.

The extreme simplicity of the elements and the versatility with which they can be combined allows you to unleash the creativity of a project in countless combinations.

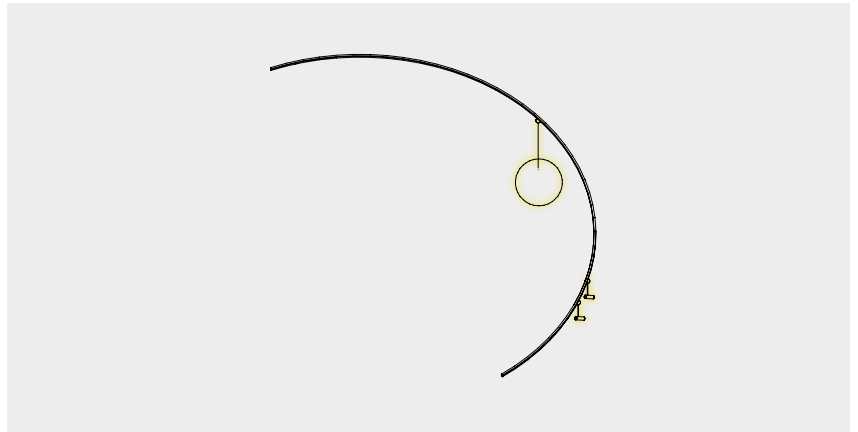
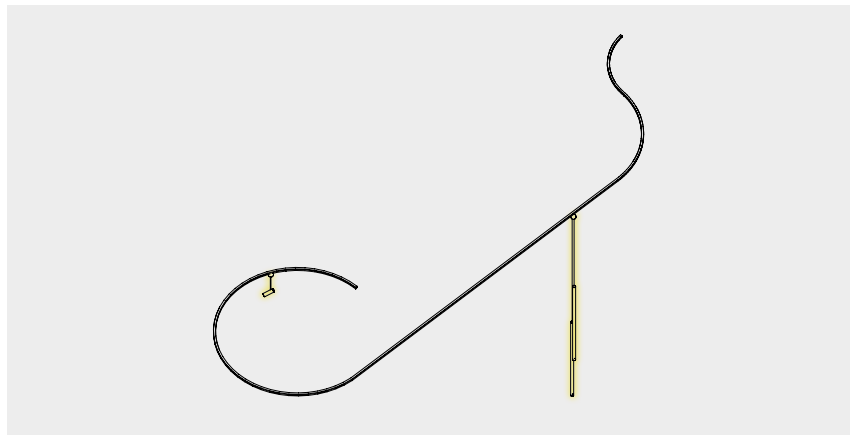
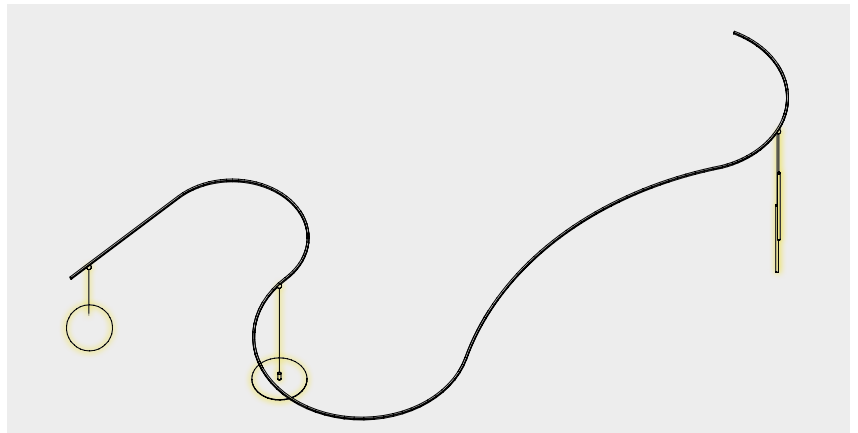
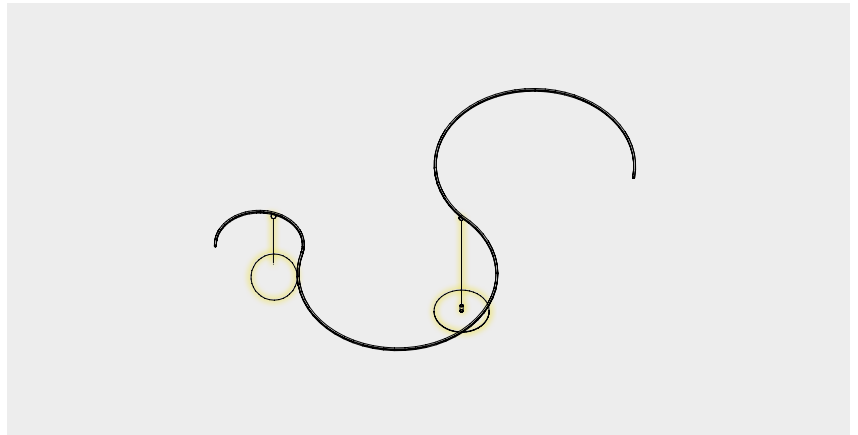



CASAMBI

Controllo individuale di ciascun apparecchio di illuminazione direttamente attraverso un'applicazione per tablet e smartphone (FLOS Control®).

Individual control of each luminaire directly through a tablet or smartphone application (FLOS Control®).

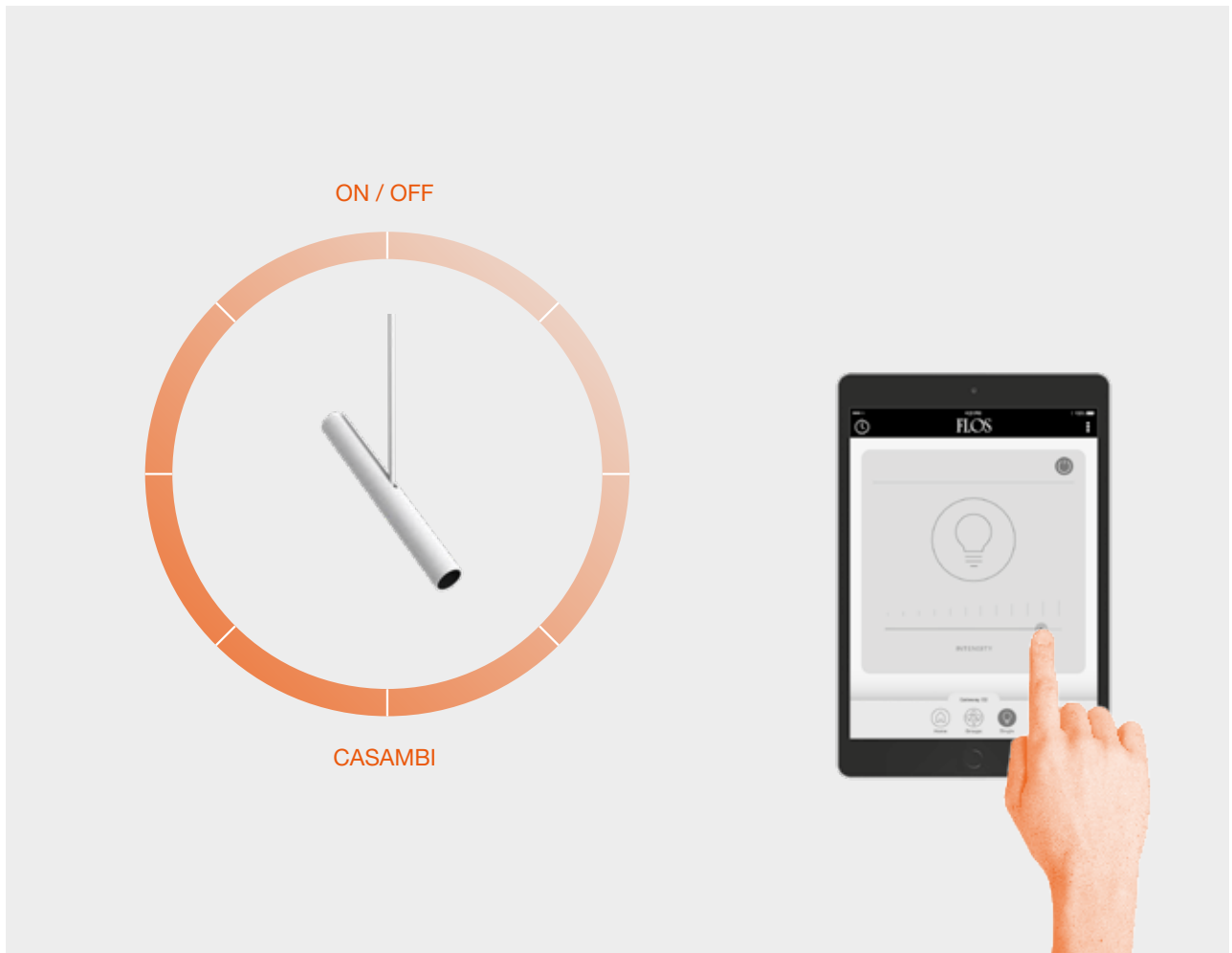

FLOS CONTROL®
BY CASAMBI

L'applicazione FLOS Control® consente di controllare gli apparecchi di illuminazione del sistema in gruppo, controllando scene e programmazione.

In un impianto elettrico tradizionale, con il gateway connesso via Bluetooth si ottiene un controllo totale dell'ambiente.

Disponibile per iOS e Android

The FLOS Control® application allows you to control the system's luminaires as a group, controlling scenes and programming.

With a traditional electrical installation and the Gateway connected by Bluetooth, you obtain total control of the ambience.

Available for iOS and Android

MY CIRCUIT PROFILE

C5 Bianco
 C5 White

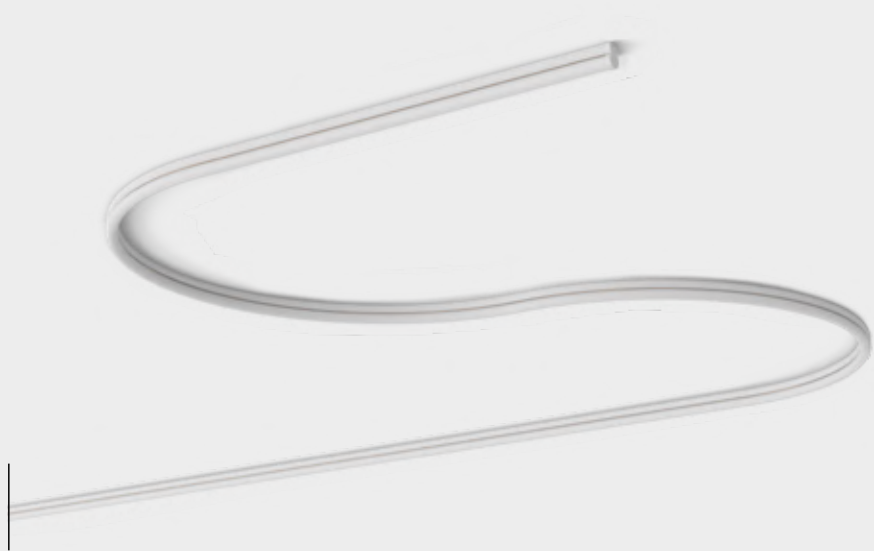

MY CIRCUIT PROFILE LIGHT MODULES

MY CIRCUIT
LIGHT SHADOW
SPOT Ø30



POWER LED
4W

MY CIRCUIT
LIGHT SHADOW
SPOT Ø45



LED ARRAY
8W

MY CIRCUIT
SPOT Ø25



POWER LED
4W

MY CIRCUIT
SPOT Ø35



LED ARRAY
8W

MY CIRCUIT PROFILE LIGHT MODULES

MY CIRCUIT
DOME

TOP LED
40W

MY CIRCUIT
SPHERE

TOP LED
40W

MY CIRCUIT
DISC

TOP LED
42W

MY CIRCUIT
LINES

TOP LED
2 x 23W



Spot



Medium



Flood



Wide Flood



Diffused

B

B

E

E

L

L

T

Linea di luce tecnica avvolta all'interno di un pregiato rivestimento (pelle naturale o tessuto) cucito su misura per integrare ogni elemento della composizione. L'innovativo sistema di connessione è stato sviluppato per ottenere una linea sinuosa senza apparente soluzione di continuità.

Technical lighting line covered in a sewn to measure, fine leather or textile fabric cover that integrates all elements of the composition. The innovative connection system has been developed to achieve a sinuous line without apparent interruptions.

BELT

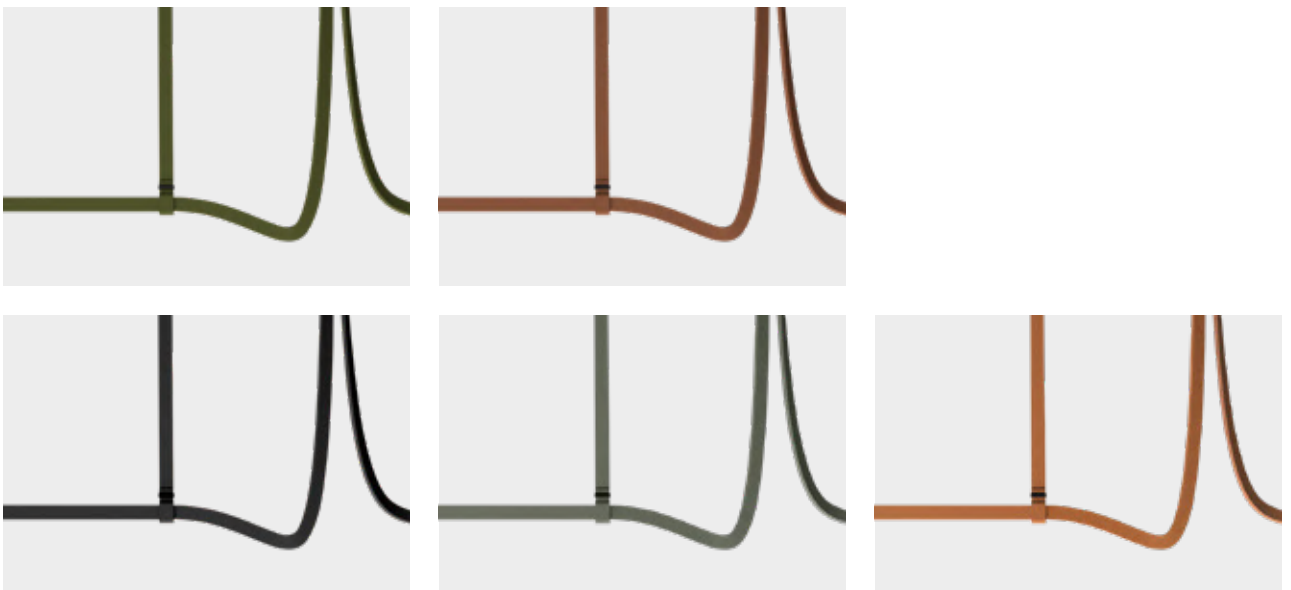





Il rivestimento (di pelle o tessuto) rappresenta il cuore del progetto. Un materiale morbido e caldo che garantisce libertà nello spazio ma al tempo stesso caratterizzato da una certa rigidità che crea armonia nel risultato della composizione finale. A sua volta, la versione Belt Fabric è rivestita in un tessuto tecnico speciale con due finiture: grey olive e copper brown.

The leather or textile fabric is the heart of the project. A soft and warm material that guarantees freedom in the space but, at the same time, is characterized by certain rigidity. The result is a harmonious final composition. Belt is covered in fine leather, treated with natural dyes to obtain the three finishes available in the range: black, green and natural leather. Belt Fabric is covered in a special technical fabric offering two decorative finishes with a knitted texture: grey olive and copper brown.

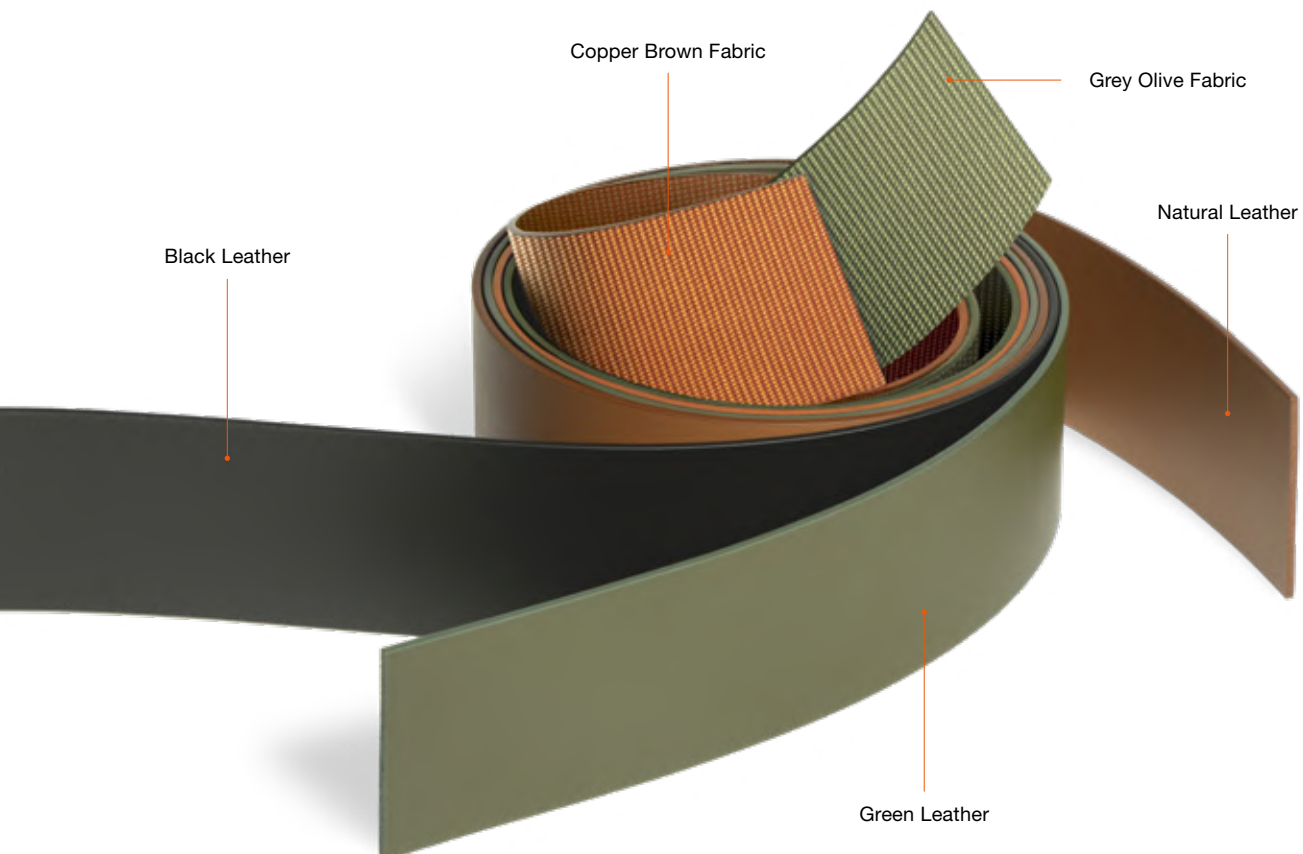



Belt è pura flessibilità, una linea sinuosa la cui natura è in equilibrio tra la morbidezza della rifinitura in pelle o tessuto e la rigidità dell'alluminio. L'elemento morbido è rappresentato dalla connessione alla rete elettrica, mentre le parti rigide corrispondono alle sorgenti luminose, delle lunghe linee di luce.

Belt is pure flexibility, a sinuous line whose nature is in balance between the softness of the leather or the fabric and the rigidity of aluminium. The soft element is represented by the connection to the electrical grid, while the rigid parts correspond to the light sources, which are long lighting lines.

- 1 CEILING FEEDING BASE
- 2 ELECTRICAL LOOP CONNECTOR
- 3 CEILING MOUNTING
- 4 SUSPENSION BELTS
- 5 LIGHT PROFILE







Ogni elemento del prodotto è gestito tramite strisce di pelle o tessuto. Alcune di queste sostengono il peso dell'apparecchio, altre trasportano l'elettricità e ovviamente alcune contengono la luce. La sezione iniziale di ogni composizione scende dal soffitto, oppure sale dalla parete o ancora dal pavimento per poi essere sospesa attraverso tiranti dedicati.

Each element of the product is controlled by leather or textile fabric straps. Some of them support the weight of the device, some carry electricity and some contain light. The initial section of each composition descends from the ceiling or rises from the wall, or even from the floor, and then hangs thanks to dedicated straps.

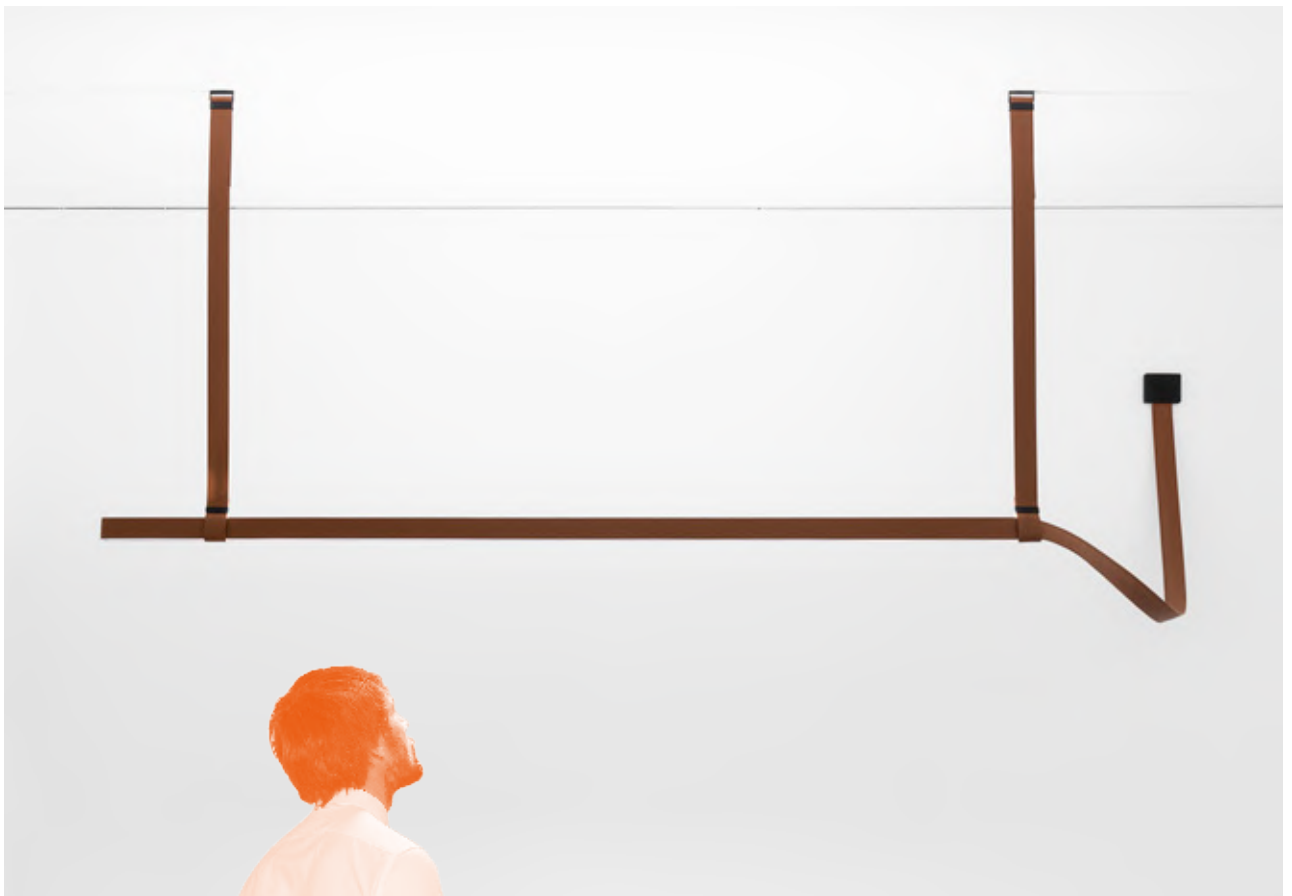
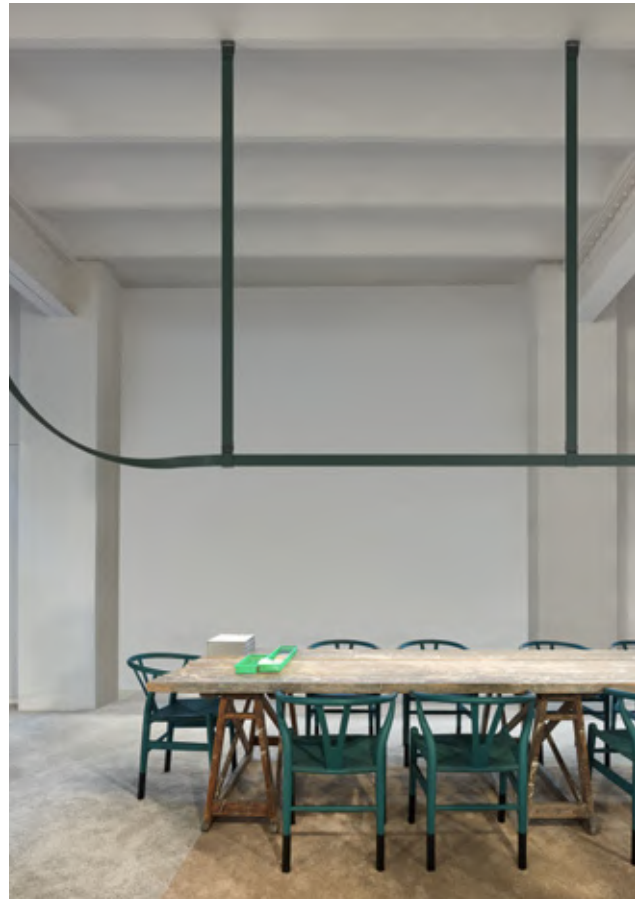

FULL VISUAL COMFORT



Come quando si allaccia una cintura, l'installazione dei tiranti utilizzati per sospendere il profilo luminoso avviene facendo scorrere le fasce attraverso fibbie in metallo dedicate che fungono da agganci a soffitto. Ogni tirante può essere regolato per rispettare la conformazione dell'ambiente.

As for fastening a belt, the installation of the straps used to hang the lighting profile is done by sliding the straps through dedicated metal buckles that act as ceiling hooks. Each strap can be adjusted to respect the configuration of the environment.

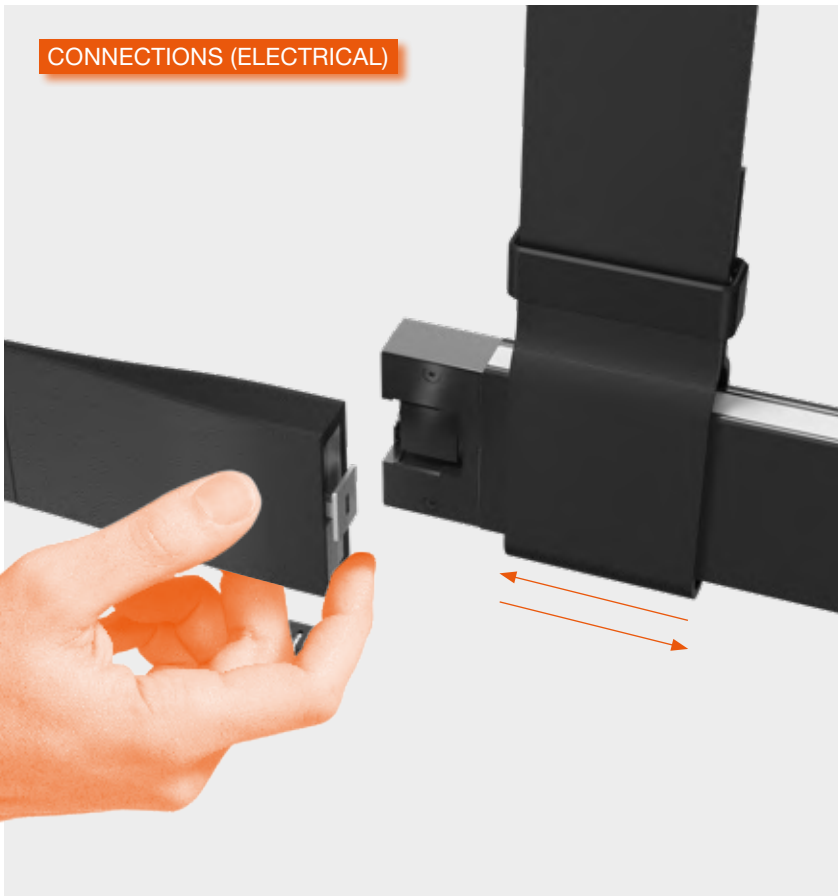

CONNECTIONS (ELECTRICAL)

Lo speciale microconnettore integrato nel terminale del profilo luminoso permette di realizzare la connessione elettrica attraverso un semplice scatto. L'elemento di connessione viene nascosto all'interno del passante, che funge da sospensione per sostenere la composizione.

The special micro-connector integrated in the terminal of the lighting profile allows the electrical connection to be made with a simple click. The connection element is hidden inside the strap that acts as a suspension to support the composition.

CONNECTIONS (ELECTRICAL)







La lunghezza dei profili luminosi e dei tiranti può variare secondo le esigenze di progetto. Nella gamma sono disponibili sei lunghezze diverse, per consentire alla composizione di adattarsi allo spazio crescendo, ruotando, salendo o scendendo in tre dimensioni.

The length of the lighting profiles and the straps can be changed according to the requirements of the project. The range offers six different lengths so the composition can be adapted to the space by growing, rotating, rising or descending in three dimensions.

PROFILES

3000 mm



2000 mm



STRAPS

3000 mm



2000 mm



1500 mm



1000 mm











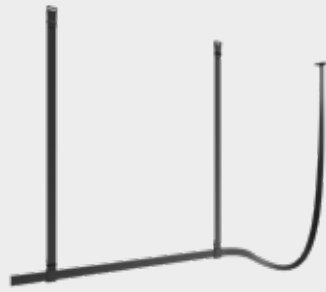

TOP LED
27,5W/m

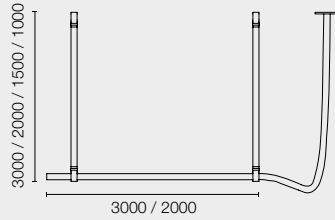

■ GN Green



■ 18 Natural Leather



■ 14 Black



■ GO Grey Olive



■ M5 Copper Brown

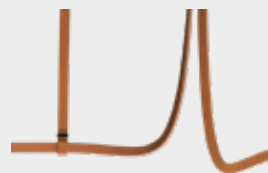

Flood
Up&Down

INFRA-STRUCTURE

INFRA-STRUCTURE
INFRA-STRUCTURE

INFRA-STRUCTURE

INFRA-STRUCTURE

INFRA-STRUCTURE
INFRA-STRUCTURE

INFRA-STRUCTURE

INFRA-STRUCTURE

INFRA-STRUCTURE

INFRA-STRUCTURE
INFRA-STRUCTURE

INFRA-STRUCTURE
INFRA-STRUCTURE
INFRA-STRUCTURE

INFRA-STRUCTURE

Struttura tubolare compatibile con un'ampia gamma di apparecchi di illuminazione con fissaggio magnetico e blocco meccanico di sicurezza. Regolazione e controllo mediante protocolli universali e attraverso l'applicazione FLOS Control®.

Tubular structure compatible with a wide range of light fixtures with magnetic fastening and mechanical safety locking. Regulation and control with universal protocols and using the FLOS Control® application.

INFRA-STRUCTURE





The Conran Shop, Seoul

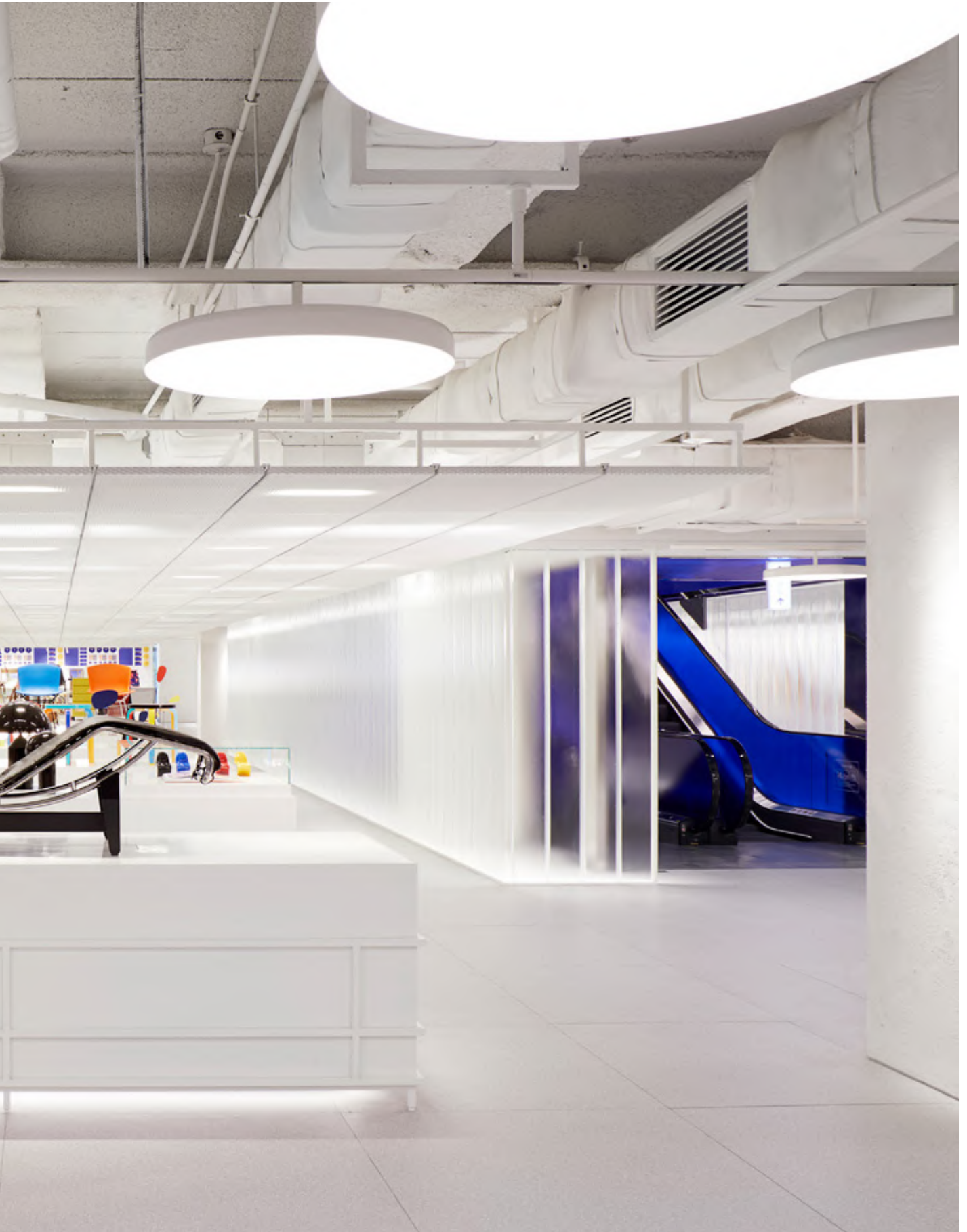

La nuova icona nelle strutture d'illuminazione: grazie al suo design esclusivo e alla tecnologia magnetica, Infra-Structure offre un sistema unico su cui sviluppare il design d'illuminazione nello spazio architettonico. Compatibile con tutti i sistemi di controllo e con FLOS Control®.

The new icon in lighting structures: thanks to its unique design and magnetic technology Infra-Structure offers a singular way to grow your lighting design in the architectural space. Compatible with all control systems and FLOS Control®.



- 1 SPOT / LIGHT SHADOW SPOT
- 2 LIGHT TUBE
- 3 SUSPENSION PANEL
- 4 SUSPENSION GLASS DOWNLIGHT
- 5 MULTIFUNCTION SMART DEVICE











Vincent Van Duysen
Offices, Belgium
Bottom

Cantina 51 - Parc 51,
Belgium
Top

LIGHT TUBE / SUSPENSION PANEL 600

Diffusore opale ad alta efficienza che consente una distribuzione uniforme garantendo un elevato comfort visivo.

Highly efficient opal diffuser, which allows for uniform distribution and guarantees high levels of visual comfort.

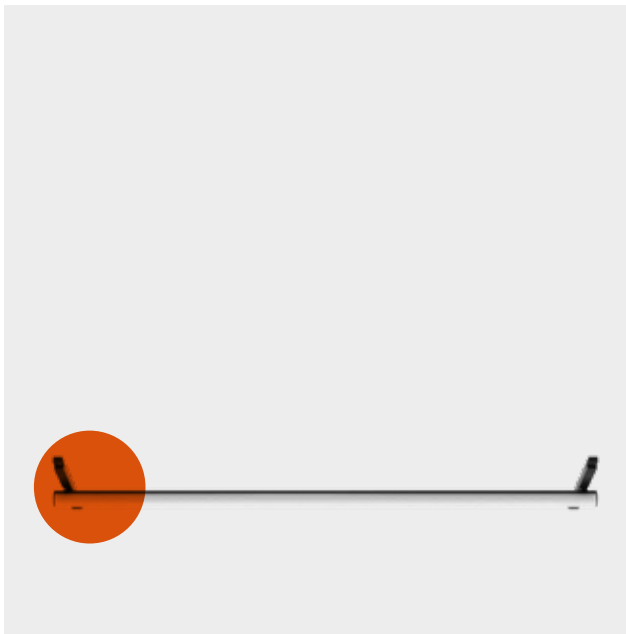

SPOT / LIGHT SHADOW SPOT

Infra Structure dispone di farette *Spot* e *Light Shadow Spot*. Mentre i moduli d'illuminazione *Spot* dispongono di riflettori ad alta efficienza, quelli *Light Shadow Spot* si servono delle loro lenti bifocali, una tecnologia ottica brevettata ed esclusiva. (1)

Infra-Structure has *Spot* and *Light Shadow Spot* projectors. Spot light modules feature high-efficiency reflectors, while *Light Shadow Spots* benefit from their own patented and exclusive optical technology, with dual-focus lenses. (1)



SUSPENSION GLASS / DOWNLIGHT 110

Campana decorativa in vetro soffiato, disponibile nelle finiture trasparente, fumée e rosso.

Decorative bell in blown glass. Available in transparent, fumee and red finishes.

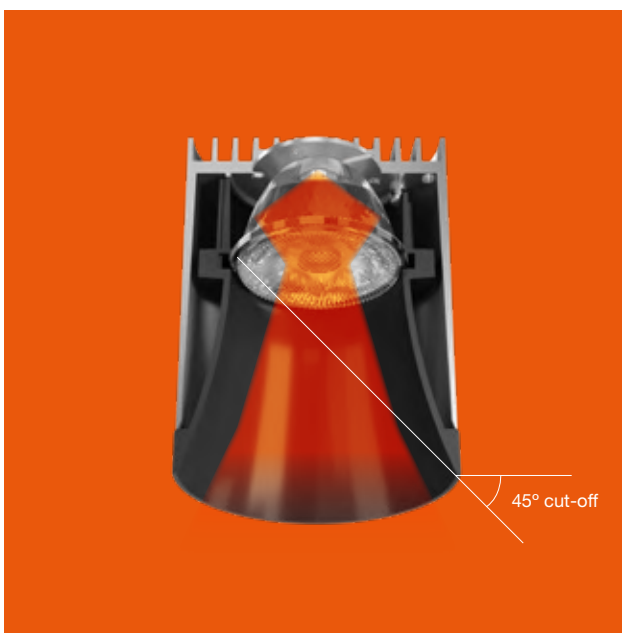











Vincent Van Duysen
Offices, Belgium

	Diverse opzioni di controllo che possono adattarsi a qualunque necessità.	Different control options that can be adapted to any need.
ON BOARD DIMMING	Ciascun apparecchio di illuminazione ha un dimmer integrato, per il controllo diretto e individuale.	Each luminaire has its own integrated dimmer for direct and individual control.
DALI	Controllo individuale di ciascun apparecchio di illuminazione.	Individual control of each luminaire.
1-10V	Controllo remoto in broadcasting (dimmeraggio di tutti gli apparecchi di illuminazione in gruppo).	Broadcasting remote control (dimming of all the luminaires in a single group).
CASAMBI	Controllo individuale di ciascun apparecchio di illuminazione direttamente attraverso un'applicazione per tablet e smartphone (FLOS Control®).	Individual control of each luminaire directly through a tablet or smartphone application (FLOS Control®).



FLOS CONTROL®
BY CASAMBI

L'applicazione FLOS Control® consente di controllare gli apparecchi di illuminazione del sistema in modo individuale o in gruppo, controllando scene e programmazione.

In un impianto elettrico tradizionale, con il gateway connesso via Bluetooth si ottiene un controllo totale dell'ambiente.

Disponibile per iOS e Android

The FLOS Control® application allows you to control the system's luminaires individually or as a group, controlling scenes and programming.

With a traditional electrical installation and the Gateway connected by Bluetooth, you obtain total control of the ambience.

Available for iOS and Android

LIGHT MODULES

SUSPENSION
PANEL 600



TOP LED
40W

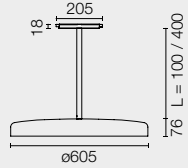

SUSPENSION
GLASS DOWNLIGHT 110



LED ARRAY
13,5W

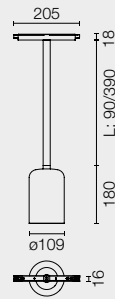

40 Bianco
 40 White
 14 Nero
 14 Black



MULTIFUNCTION
SMART DEVICE



FLOS CONTROL®
by Casambi

INFRA-STRUCTURE
EPISODE 2

INFRA-STRUCTURE
EPISODE 2

INFRA-STRUCTURE
EPISODE 2

INFRA-STRUCTURE
EPISODE 2

INFRA-STRUCTURE
EPISODE 2

INFRA-STRUCTURE
EPISODE 2

INFRA-STRUCTURE
EPISODE 2

INFRA-STRUCTURE
EPISODE 2

Essenziale struttura tubolare incredibilmente versatile. Grazie ad uno speciale sistema di connessione è possibile combinare elementi verticali e orizzontali tra di loro per creare combinazioni tridimensionali in infinite varianti utilizzando moduli lineari e geometrici.

Subtle, incredibly versatile tubular structure. Thanks to a special connection system, it is possible to combine vertical and horizontal elements to create three-dimensional combinations in infinite variations using linear and geometric modules.

INFRA-STRUCTURE Episode 2



La reinterpretazione di un'icona: il design unico di Infra-Structure si evolve grazie ad un nuovo concetto modulare estremamente semplificato. Elementi essenziali ma di grande impatto visivo possono essere combinati per caratterizzare qualsiasi spazio architettonico con una forte presenza scenica.

The reinterpretation of an icon: the unique design of Infra-Structure evolves thanks to a new, extremely simplified modular concept. The subtle but visually stunning elements can be combined to characterize any architectural space with a strong stage presence.



- 1 SUSPENSION CONE
- 2 STRUCTURAL RODS
- 3 LIGHT TUBE DIRECT
- 4 LIGHT TUBE INDIRECT
- 5 SUSPENSION PANEL



SUSPENSION CONE

Il modulo conico prevede una schermatura totale della sorgente luminosa e integra uno speciale gruppo ottico brevettato per ottenere effetti di luce puntuale professionali ad alto contrasto.

The conical module provides total shielding of the light source and integrates a special patented optical unit to achieve professional high-contrast spotlighting effects.



LIGHT TUBE

I moduli lineari orizzontali possono essere utilizzati per ottenere luce diretta e indiretta. Rappresentano un segno grafico importante nella struttura, creano ritmicità e continuità visiva nell'installazione attraverso una luce morbida e diffusa.

The horizontal linear modules can be used to obtain direct and indirect light. They represent an important graphic sign in the structure, creating rhythm and visual continuity in the installation through soft and diffused light.

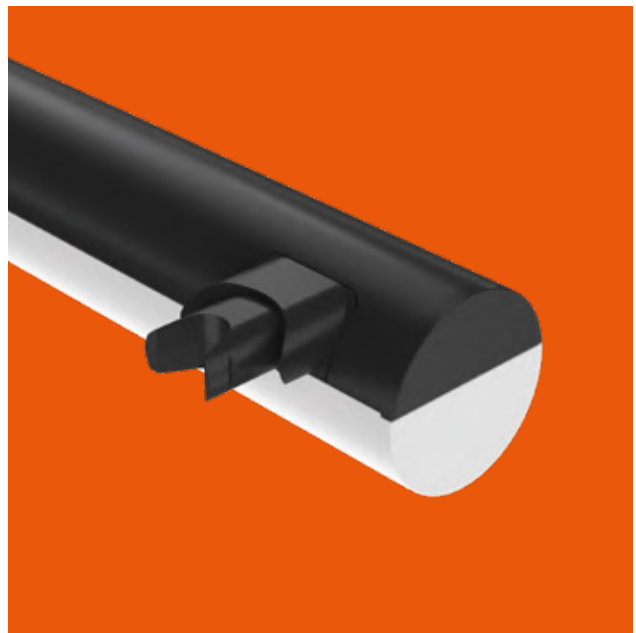

SUSPENSION PANEL

Il pannello circolare è realizzato con uno speciale aggancio che lo rende particolarmente semplice da installare nella struttura. Il profilo interno è in finitura nera a contrasto con il grande diffusore opale ad alta efficienza che garantisce un comfort visivo assoluto.

The circular panel is manufactured with a special hook that makes it very easy to install on the structure. The internal profile features a black finish that contrasts with the large, highly efficient opal diffuser, guaranteeing high levels of visual comfort.



LIGHT TUBE COVERED

Il modulo lineare trapezoidale nasconde alla vista l'emissione diretta della luce schermando il diffusore opale dell'apparecchio e concentrando la luce sul piano di lavoro.

The trapezoidal linear module protects the eyes from direct light emission by acting as a screen for the opal diffuser of the luminaire and by concentrating the light on the work surface.









La connessione meccanica tra i singoli moduli che compongono la struttura avviene tramite un sistema a vite che garantisce u'installazione rapida e sicura. Ogni modulo è bloccato in sede con l'integrazione di un piccolo grano, pressochè invisibile una volta completata l'installazione.

The mechanical connection between the individual modules that make up the structure is made through a screw system that guarantees a fast and safe installation. Each module is locked in place by integrating a small, almost invisible grub screw once the installation is complete.



Le connessioni elettriche dei moduli illuminanti sono estremamente semplici da effettuare. Ogni elemento luminoso è completo con un cavo elettrico lungo 5 m equipaggiato con micro-connettore in uscita. Il cavo viene fatto scorrere attraverso le varie sezioni della struttura verticale per essere poi collegato alla rete centrale in corrispondenza del soffitto.

The electrical connections of the lighting modules are extremely simple to make. Each lighting element is completed by a long 5m electrical cable equipped with an output micro-connector. The cable runs through all the different sections of the vertical structure and is then connected to the central grid in the ceiling.

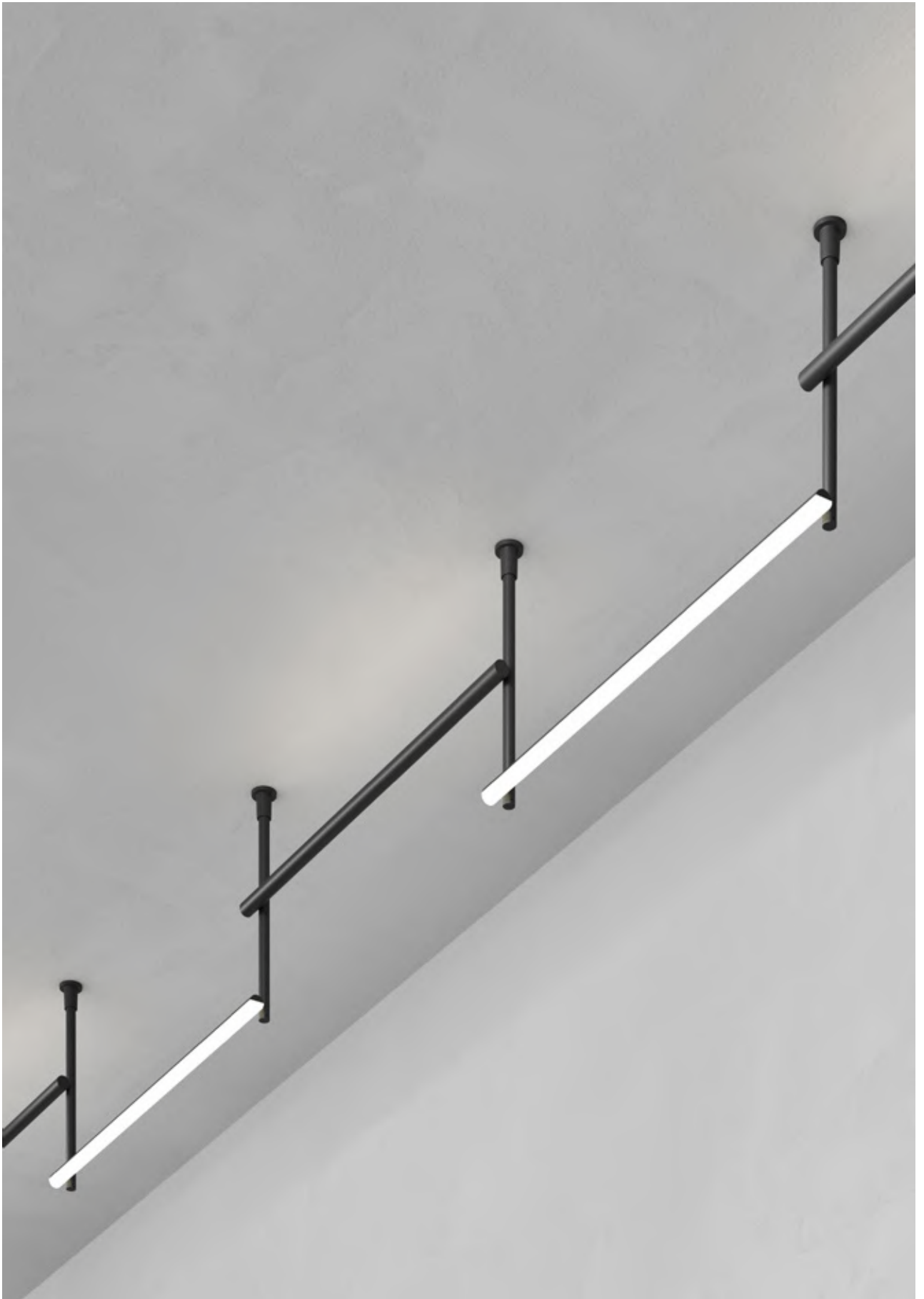







CONFIGURAZIONE

L'estrema semplicità degli elementi e la rapidità con cui possono essere combinati permette di liberare la creatività del progetto ottenendo innumerevoli combinazioni.

CONFIGURATION

The extreme simplicity of the elements and the speed with which they can be combined allows to free up the creativity of the project and to achieve innumerable combinations.

EXAMPLE NO.1

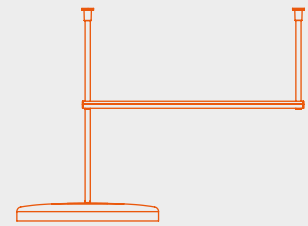

- 2 x Top Anchor
- 2 x Light Tube Rod 400mm
- 1 x Direct Light Tube 900mm
- 1 x Suspension Rod 400mm
- 1 x Suspension Panel 600mm
- 1 x End Cap

EXAMPLE NO.2



- 4 x Top Anchor
- 2 x Light Tube Rod 400mm
- 4 x Light Tube Rod 200mm
- 2 x Direct Light Tube 900mm
- 1 x Indirect Light Tube 900mm
- 4 x End Caps

EXAMPLE NO.3

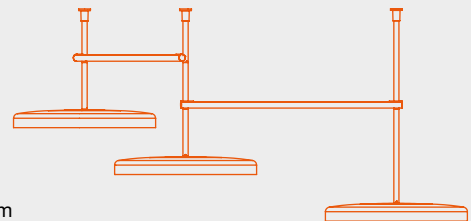

- 3 x Top Anchor
- 1 x Light Tube Rod 400mm
- 3 x Light Tube Rod 200mm
- 1 x Indirect Light Tube 900mm
- 1 x Indirect Light Tube 1500mm
- 1 x Suspension Rod 400mm
- 2 x Suspension Rod 200mm
- 3 x Suspension Panel ø600mm

EXAMPLE NO.4

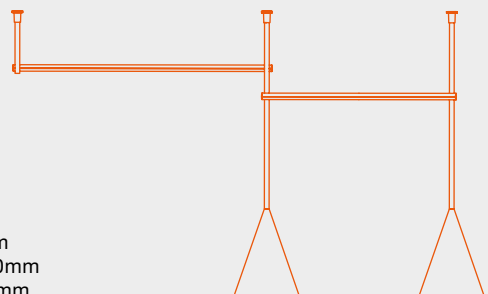

- 3 x Top Anchor
- 2 x Light Tube Rod 200mm
- 2 x Light Tube Rod 100mm
- 1 x Suspension Rod 200mm
- 1 x Indirect Light Tube 1200mm
- 1 x Indirect Light Tube 900mm
- 2 x Suspension Rod 400mm
- 2 x Suspension Cone ø300
- 1 x End Cap

Come in un reticolo tridimensionale, basterà definire quali sono gli assi verticali della struttura per poi unirli visivamente (ed elettricamente) a dei moduli luminosi che possono ruotare liberamente di 360° garantendo un'incredibile flessibilità d'installazione.

As in a three-dimensional network, simply define the vertical axes of the structure and then connect them visually (and electrically) with lighting modules that can freely rotate 360°. An incredible installation flexibility is guaranteed.

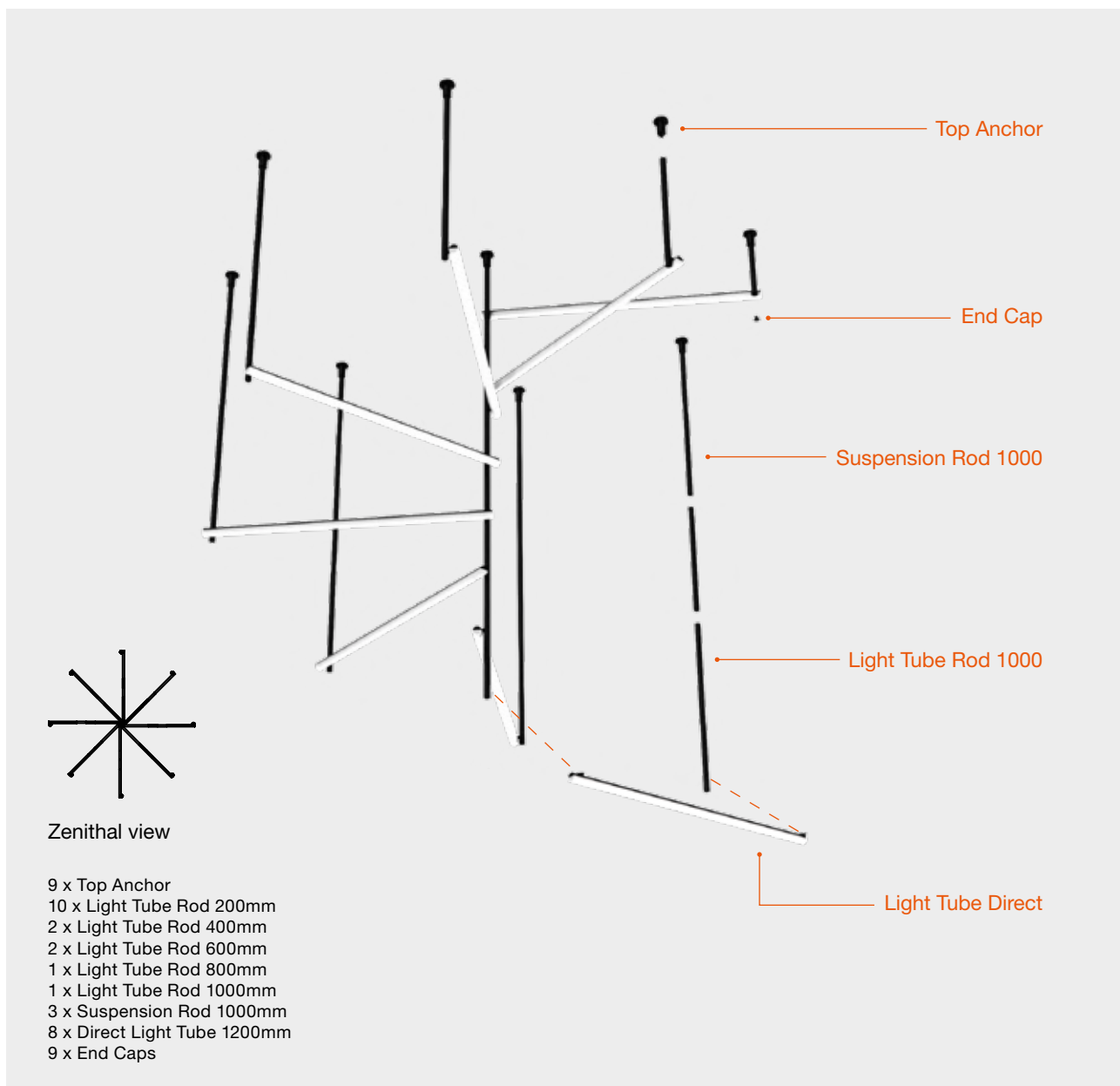





	Diverse opzioni di controllo che possono adattarsi a qualunque necessità.	Different control options that can be adapted to any need.
DALI	Controllo broadcast di ciascun apparecchio di illuminazione.	Broadcast control of each luminaire.
1-10V	Controllo remoto in broadcasting (dimmeraggio di tutti gli apparecchi di illuminazione in gruppo).	Broadcasting remote control (dimming of all the luminaires in a single group).
CASAMBI	Controllo individuale di ciascun apparecchio di illuminazione direttamente attraverso un'applicazione per tablet e smartphone (FLOS Control®).	Individual control of each luminaire directly through a tablet or smartphone application (FLOS Control®).



FLOS CONTROL®
BY CASAMBI

L'applicazione FLOS Control® consente di controllare gli apparecchi di illuminazione del sistema in gruppo, controllando scene e programmazione.

In un impianto elettrico tradizionale, con il gateway connesso via Bluetooth si ottiene un controllo totale dell'ambiente.

Disponibile per iOS e Android

The FLOS Control® application allows you to control the system's luminaires as a group, controlling scenes and programming.

With a traditional electrical installation and the Gateway connected by Bluetooth, you obtain total control of the ambience.

Available for iOS and Android

LIGHT MODULES

LIGHT TUBE
DIRECT - INDIRECT



TOP LED
24W/m

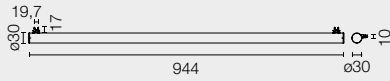

SUSPENSION
CONE Ø30



LED ARRAY
30W

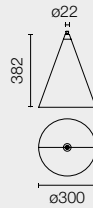

SUSPENSION
CONE Ø40



LED ARRAY
41W

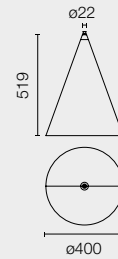

SUSPENSION
PANEL 600



TOP LED
35,5W

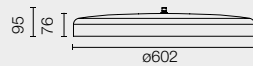

LIGHT TUBE
COVERED



TOP LED
24W/m

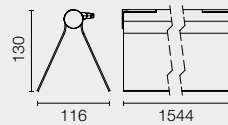

Spot



Medium



Flood



Diffused

40 Bianco
40 White

14 Nero
14 Black



FLOS
CONTROL BY CASAMBI



GUSTAVE GUSTAVE

GUSTAVE GUSTAVE

GU AVE

GUSTAV USTAVE

GUSTAV USTAVE

GUSTAV USTAVE

GUSTAV USTAVE

GUSTAV USTAVE

GUST TAVE

GUSTAVE GUSTAVE

GUSTAVE GUSTAVE

Elegante lampada portatile da tavolo. Illuminazione asimmetrica a 360°, ad ampio raggio. Versioni per la casa e per servizi alberghieri. Disegno circolare che evita l'obsolescenza e l'impatto ambientale.

Elegant, portable luminaire for tabletop lighting. Wide range, 360°, asymmetrical light emission. Home and hospitality versions. Circular design to avoid obsolescence and environmental impact.

GUSTAVE



LUCE ASIMMETRICA

Omogeneità della luce perfetta fino a 1 metro. Ottimizzazione del raggio luminoso nelle applicazioni archetipiche di tavoli da 4 commensali. Comfort visivo insuperabile.

ASYMMETRIC LIGHT

Up to 1 meter of perfect light homogeneity. Optimized reach for archetypal applications for tables hosting up to 4 guests. Unbeatable visual comfort.



ILLUMINATED AREA
OF 1 METER IN DIAMETER



HIGH VISUAL CONFORT

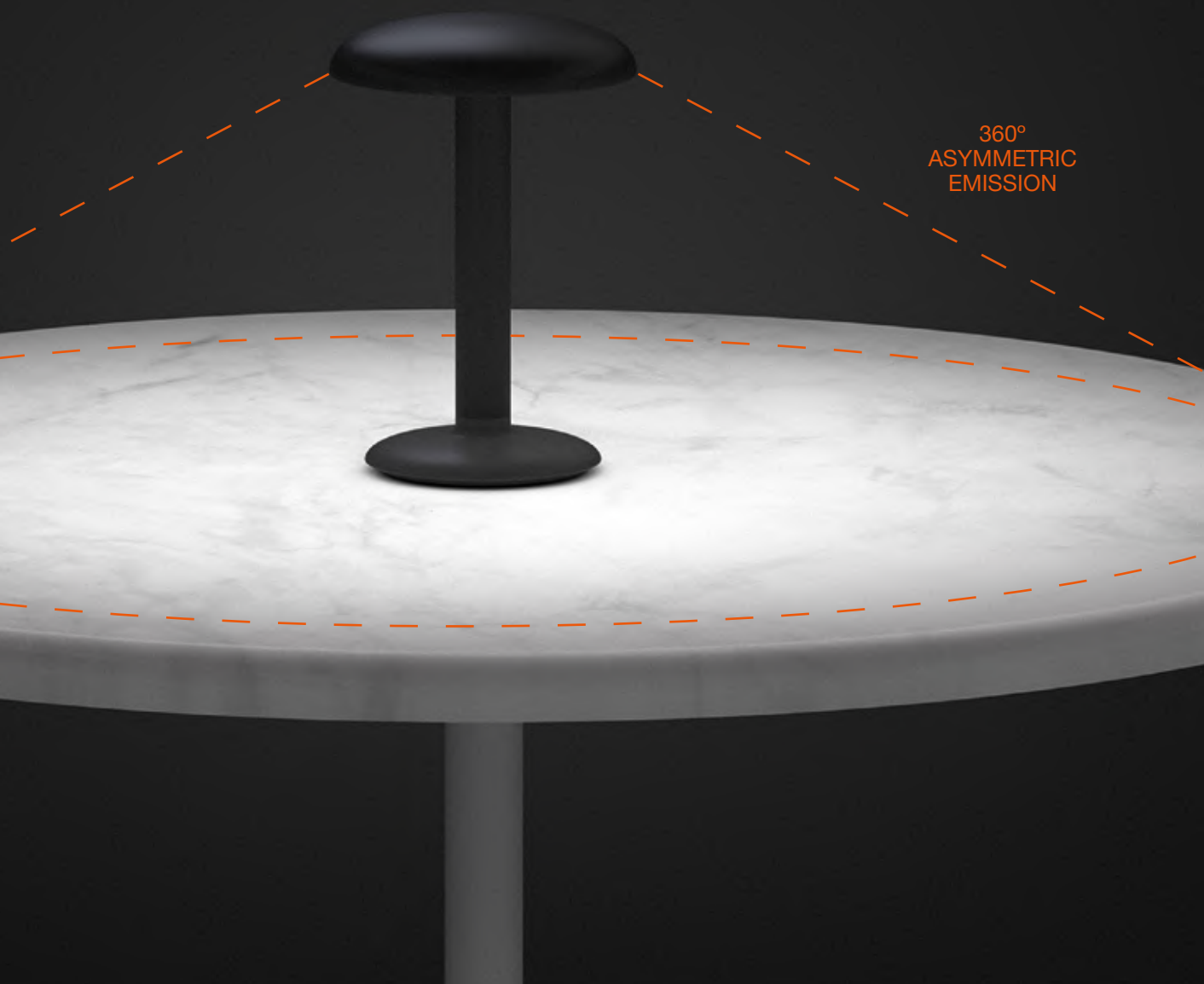

360°
ASYMMETRIC
EMISSION







Sistema ottico esclusivo e brevettato da Flos. Lenti disposte a rotazione per un'illuminazione asimmetrica a 360°. Ampio raggio d'illuminazione, occupando uno spazio minimo. Eccellente qualità dell'illuminazione sul piano di lavoro.

Exclusive optical system patented by Flos. Lenses arranged in revolution for a 360° asymmetrical emission. Wide extension of the illuminated area with minimum space taken. Excellent light quality on the work surface.

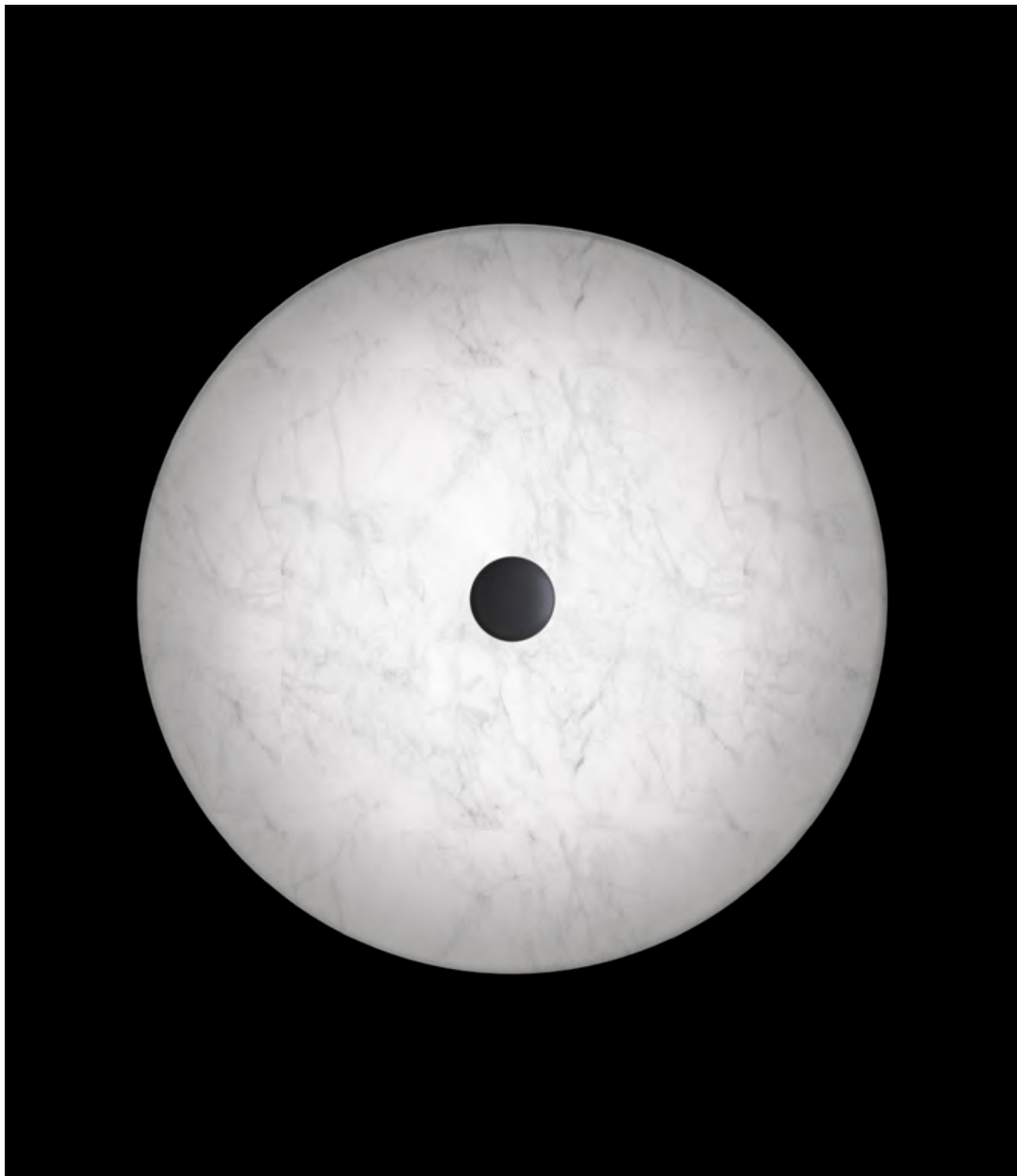





VERSIONE RESIDENTIAL

La compagna ideale di casa.

RESIDENTIAL VERSION

The ideal household partner.

1. Si ricarica mediante cavo USB-C. Indicatore LED per la gestione della ricarica e dell'autonomia. Tempo di ricarica di 5-6 ore. Autonomia: 6 ore al 100%, 10 ore al 50% e 18 ore al 25%.

Charging via USB-C cable. LED indicator for charge and autonomy management. Charging time: 5h to 6h. Autonomy: 6h at 100%, 10h at 50% and 18h at 25%.

2. Protocollo di funzionamento integrato per ottimizzare l'autonomia del prodotto in caso di batteria scarica. Integrated operating protocol to optimize product autonomy in case of low battery.

3. Regolazione sequenziale 0-100%, mediante un pulsante tattile capacitativo. Quando la luce lampeggia, la lampada ha raggiunto l'intensità massima o minima. Memorizza l'ultima intensità.
0-100% sequential regulation by means of capacitive touch button. Flashing light indicates when the maximum or minimum intensity is reached. Last position memory.

VERSIONE HOSPITALITY

Il socio perfetto nei ristoranti.

HOSPITALITY VERSION

The perfect partner for restaurants.

1. Alimentazione a batterie estraibili tipo pila. Le pile si tolgono e si sostituiscono facilmente, garantendo così la continuità del servizio. Ricarica esterna delle pile mediante caricabatterie. Il tempo della ricarica dipende dalle caratteristiche del caricabatterie in uso. Autonomia: 12 ore al 100%, 24 ore al 50% e 48 ore al 25%. Indicatore LED per la gestione dell'autonomia. Powered by removable batteries. Easy removal and change of batteries to avoid service interruptions. External battery charging by dedicated charger. Charging time depending on the characteristics of the charger used. Autonomy: 12h at 100%, 24h at 50% and 48h at 25%. LED indicator for autonomy management.

2. Protocollo di funzionamento integrato per ottimizzare l'autonomia del prodotto in caso di batteria scarica. Integrated operating protocol to optimize product autonomy in case of low battery.

3. Regolazione della luminosità in 3 variazioni (25%, 50% e 100%), per garantire un'illuminazione uniforme di uno spazio con varie lampade Gustave.
3-step dimming (25%, 50%, 100%) to facilitate uniformity between the Gustave units sharing a space.



CONTROLLO TATTILE & INDICATORE LED

HAPTIC CONTROL & LED INDICATOR

Pulsante tattile capacitativo per interagire con la lampada: acceso, spento e regolazione. Tattilità avanzata, offre sensazioni di alta qualità. Indicatore LED per la gestione dell'autonomia. Nella versione Residential, notifica lo stato della ricarica.

Capacitive touch button for interaction with the luminaire: switching on, off and dimming. Advanced haptics, high quality perceived sensation. LED indicator for autonomy management. In the Residential version, it also informs about the charging status of the product.

ALTA TENUTA STAGNA

HIGH WATERTIGHTNESS

Indice IP54 di protezione contro l'entrata di polvere o l'infiltrazione d'acqua. Resistente a schizzi, pioggia leggera e sporcizia normale. Creata per illuminare sia una cena in casa, sia i servizi nella terrazza o nella sala di un ristorante.

IP54 protection rating against dust and water ingress. Resistant to splashes, light rain and dirt in normal use. Created to provide lighting both for dinners at home and services on the terrace or in the dining room of a restaurant.





DISEGNO CIRCOLARE. INGEGNERIA
CONTRO L'OBSOLESCENZA

Gustave (Hospitality & Residential) funziona con batterie ione-litio sostituibili. In questo modo, la vita del prodotto non è legata alla vita della batteria. Quando la batteria arriva al termine del suo ciclo di vita, può essere sostituita da una nuova. Il prodotto continua a funzionare come se fosse nuovo.

Comunque, quando la lampada diventa vecchia, l'idea del disegno circolare permette di smontarla e separarne facilmente le parti per il loro riciclaggio. Per farlo, non è necessario alcun tipo di strumento: per la sua fabbricazione non si usano né colle, né viti, né saldature.

CIRCULAR DESIGN. ENGINEERING
AGAINST OBSOLESCENCE

Gustave (Hospitality & Residential) is powered by replaceable lithium-ion batteries. Thus, the life of the product is not linked to the life of the batteries. When the batteries reach the end of their life cycle, they can be replaced with new ones. The product continues to function as it did on the first day.

Moreover, when the product comes to an end, its circular design concept allows all parts to be easily disassembled and separated for recycling. All without the need for tools: it is manufactured without glues, screws or welding.

FLOS *for Planet*



Gamma di sette rifiniture. Una selezione attenta affinché Gustave possa adattarsi a qualsiasi tipo di arredamento. Stile e distinzione allo stato puro.

Range of seven finishes. A careful selection for Gustave to adapt to any type of interior design. Pure style and differentiation.



7 colori

Rifiniture esclusive nei toni satinato e patinato, scelti da Vincent Van Duysen:
1. Matt White, 2. Matt Anthracite, 3. Laquered Brown, 4. Laquered Green, 5. Polished Silver, 6. Smooth Black, 7. Raw Aluminum.

7 colors

Exclusive matte and glossy finishes selected by Vincent Van Duysen: 1. Matt White, 2. Matt Anthracite, 3. Laquered Brown, 4. Laquered Green, 5. Polished Silver, 6. Smooth Black, 7. Raw Aluminum.



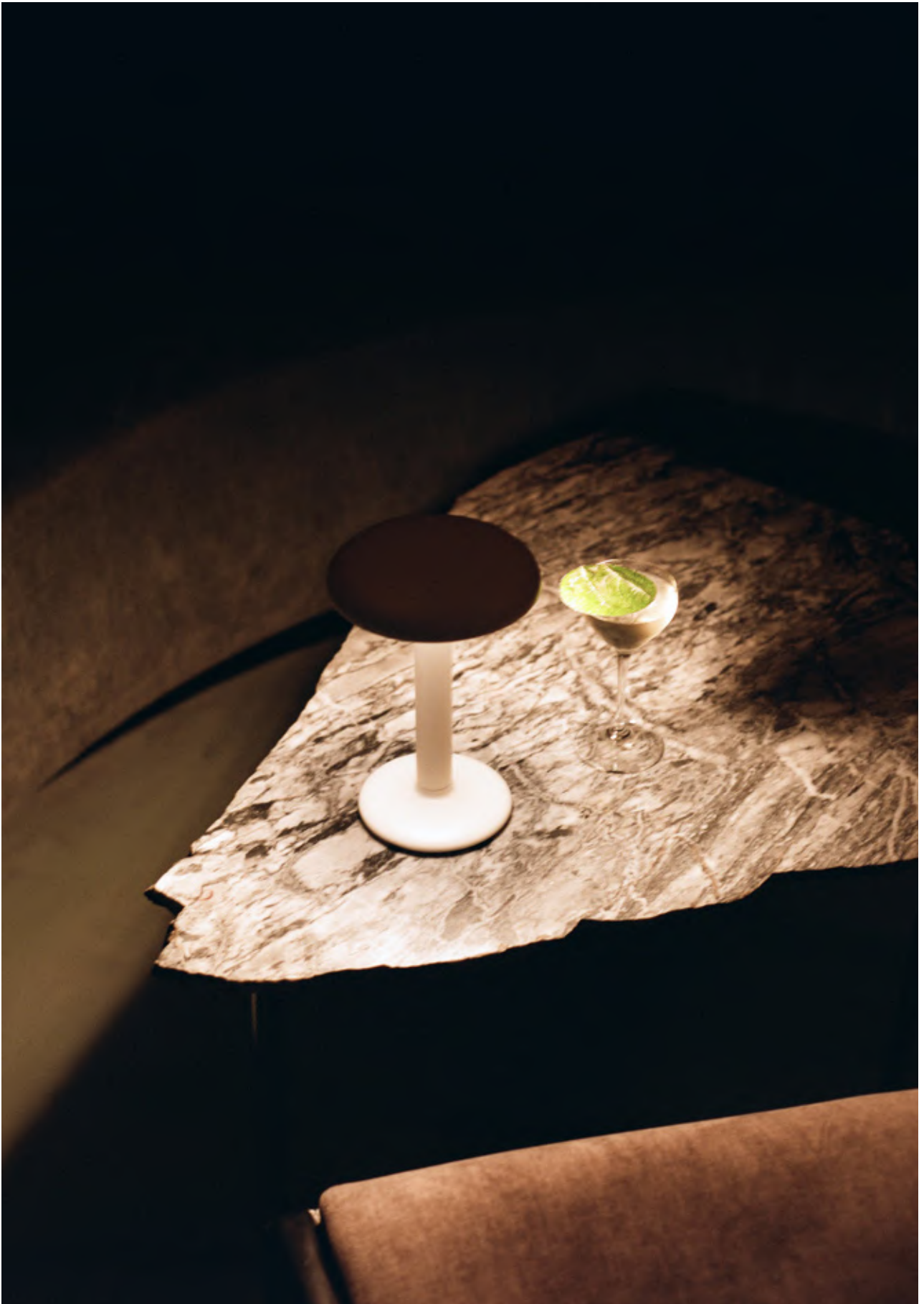

GUSTAVE HOSPITALITY
(Rechargeable batteries)

GUSTAVE RESIDENTIAL
(USB-C cable)



TOP LED
2,3W

TOP LED
2,5W

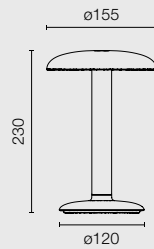

□ Matt White



■ Matt Anthracite



■ Laquered Brown



■ Laquered Green



▨ Polished Silver



■ Smooth Black



■ Raw Aluminum



Asymmetric
Flood 360°

EMI

EMI

EMI

EMI

EMI

EMI

EMI

EMI

EMI

EMI

EMI

Emi, progettata da Erwan Bouroullec, combina diverse fonti di luce ad alto comfort visivo per creare un'esperienza unica di luci e ombre. Il design di questa collezione nasce dal raggruppamento di tre moduli luminosi all'interno di estrusioni lineari e compatte che conferiscono alla lampada la forma triangolare che si riflette in tutto il suo design.

Emi, designed by Erwan Bouroullec, combines different light sources with a high level of visual comfort to create a unique experience of light and shadow. The design of this collection comes from grouping together three light modules inside compact, linear extrusions that give the lamp a triangular shape which is reflected all throughout its design.

EMI



EMI FLOOR & TABLE

La versione da terra sembra fluttuare nell'aria, sollevata da uno stelo che si collega alla base. L'illuminazione bidirezionale di questo modello è decisamente adatta alla vita contemporanea: la luce superiore ha una potenza sufficiente a illuminare l'intero spazio senza abbagliare, grazie a una conformazione specifica del fascio. La luce inferiore è morbida e tenue, perfetta da utilizzare insieme ad altre sorgenti, come una televisione o un dispositivo. La versione da tavolo funziona allo stesso modo, ma ha dimensioni più ridotte e si adatta perfettamente a qualsiasi superficie orizzontale.

The floor version seems to float in the air, disencumbered by a stem that connects to the base. The two-way lighting offered by this model is highly adapted to contemporary life: the upper light is powerful enough to illuminate the entire space without dazzling, thanks to a specific beam conformation. The lower light is soft and subdued, perfect for use with other sources such as a television or appliance. The table version operates in the same way but is smaller in size and fits perfectly on any horizontal surface.

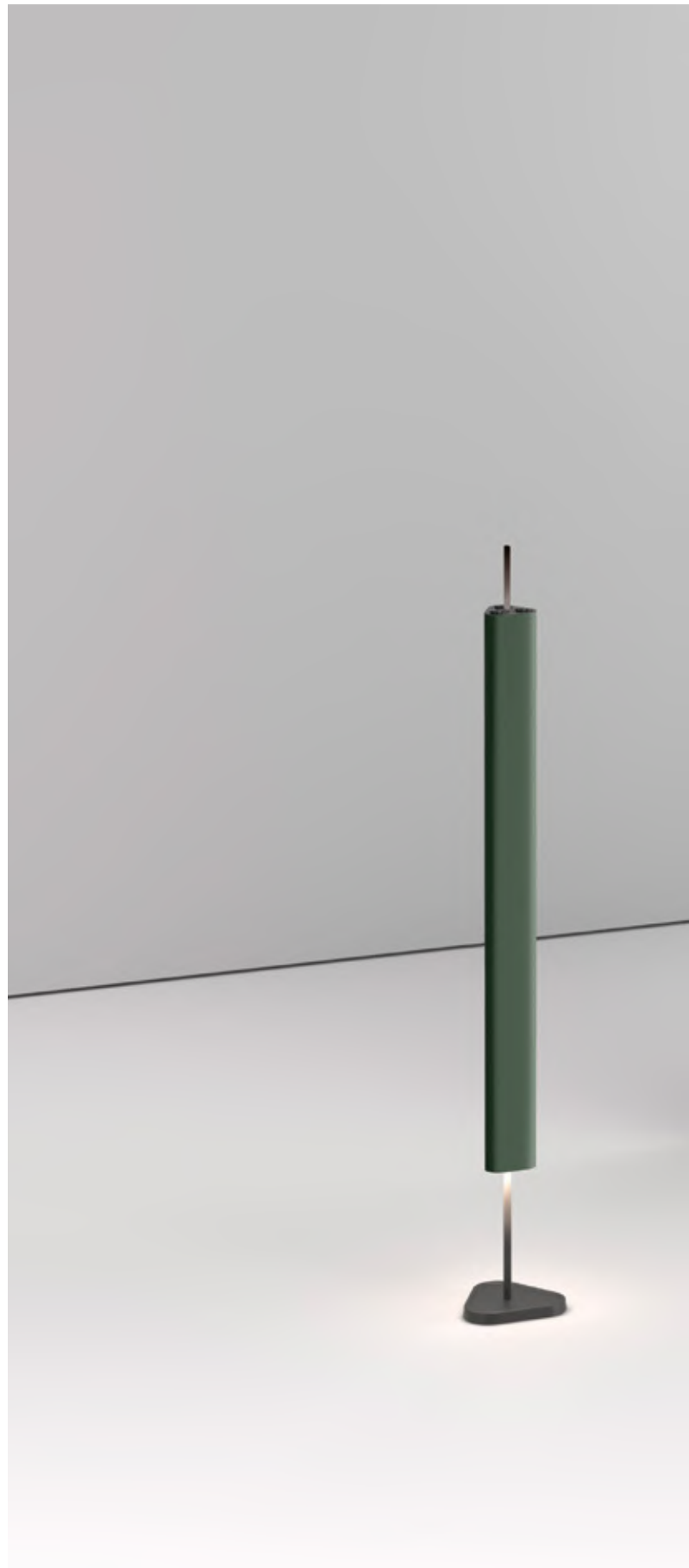





Nella versione a soffitto, EMI si presenta sia come elemento decorativo che tecnico, con un'estetica ricercata ed elegante e un'illuminazione effettiva potente e visivamente molto confortevole.

In the ceiling version, EMI is both a decorative and a technical element, with refined, elegant aesthetics and powerful and visually very comfortable effective lighting.



Emi sfrutta i benefici di una innovativa lente in silicone che permette un controllo completo del fascio a fronte di un' efficienza elevata, resistenza al calore e massima qualità nella distribuzione luminosa.

Emi exploits the benefits of an innovative silicone lens that allows absolute beam control with an extreme efficiency, heat resistance and maximum quality light distribution.



1 Lenti in silicone microtexturizzate.
Micro-textured silicone lenses.

2 Oscuratore full cut-off integrato.
Integrated full cut-off attenuator.

3 Ricambio.
Spare parts.

FLOS TECHNOLOGY

Il kit ottico disponibile comprende 4 aperture del fascio di luce diverse per *Ceiling Small*, 3 per *Ceiling Large* e 1 per le versioni *Floor* e *Table*. Ogni lente è stata sviluppata per un'applicazione speciale. Sia che si tratti di fasci di luce intensa o di effetti di luce soffusa, il controllo ottico è sempre eccezionale e la luce spuria è totalmente assente.

The available lens kit includes 4 different apertures for the beam of light for *Ceiling Small*, 3 for *Ceiling Large* and 1 for the *Floor* and *Table* versions. Every lens has been developed for a special application. Whether it is for intense beams of light or diffused lighting effects, the optical control is always exceptional and there is absolutely no spurious light.

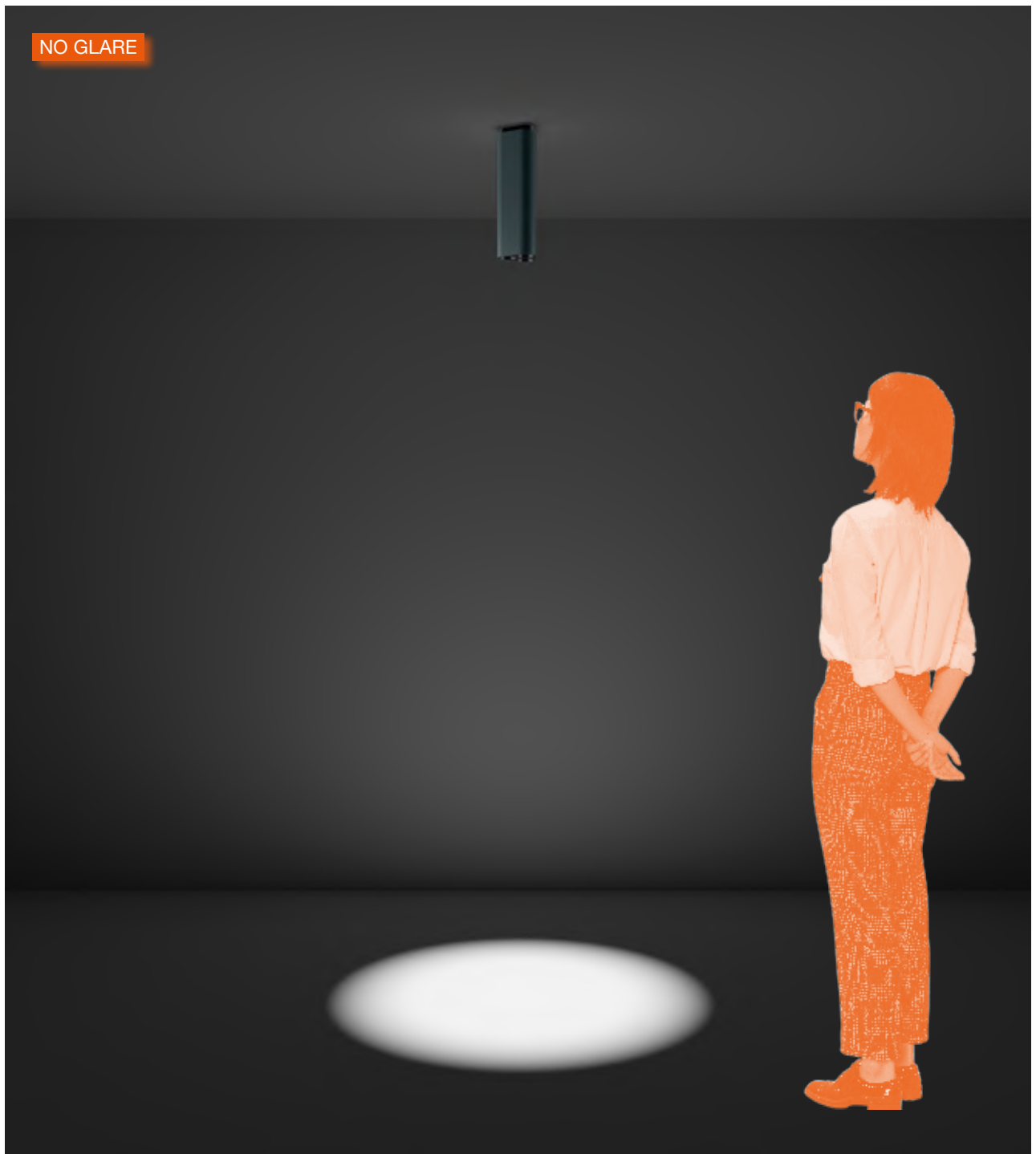

Anche accesa, EMI nasconde la sua sorgente luminosa e genera un magnifico effetto visivo: lo spazio si illumina senza rivelare da dove proviene la luce.

Even when on, EMI hides its light source and generates a magnificent visual effect: the space is illuminated without showing where the light source is.

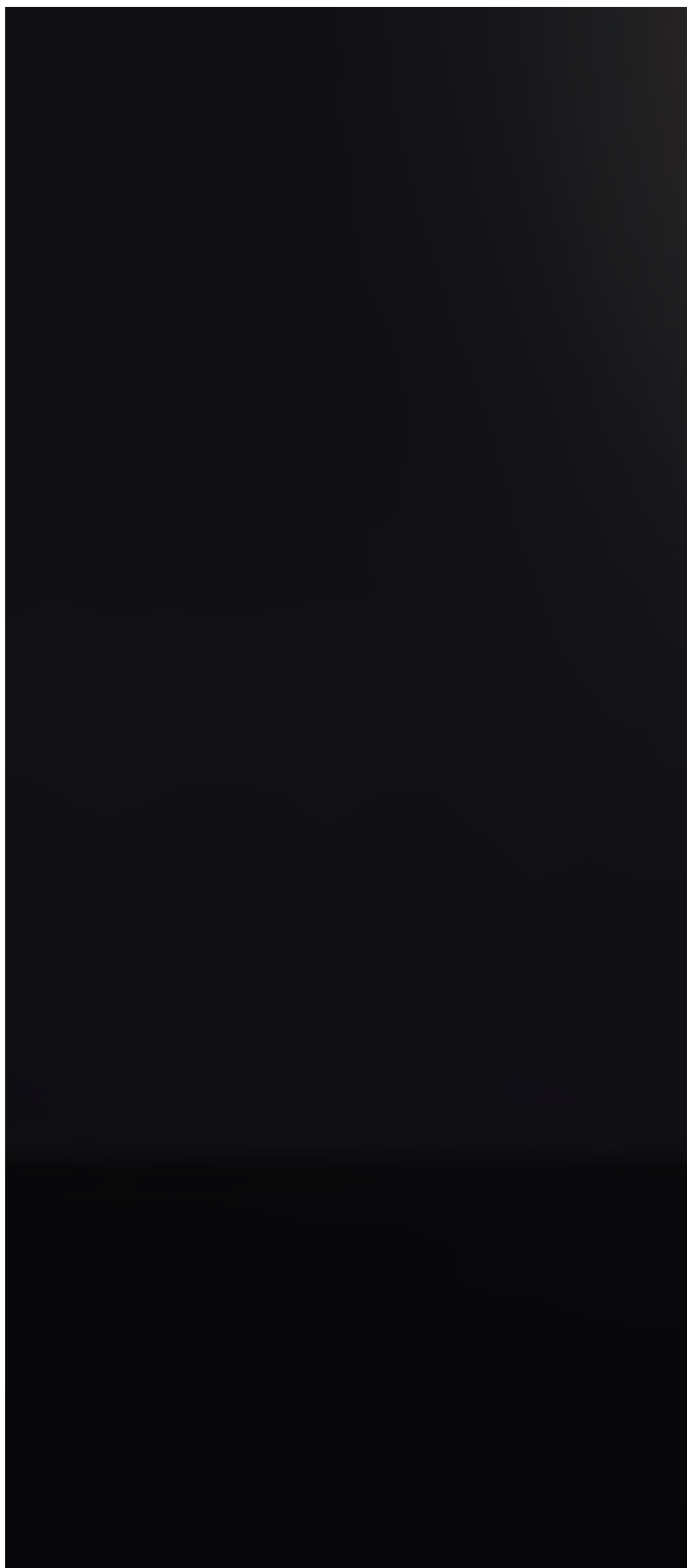



Grazie alla soluzione ottica esclusiva brevettata, Emi controlla angoli di cut-off estremi, senza rinunciare all'alta efficienza e un'incredibile versatilità del prodotto.

Thanks to the unique patented optical solution, Emi controls extreme cut-off angles without altering the high efficiency and incredible versatility of the product.

UGR<10

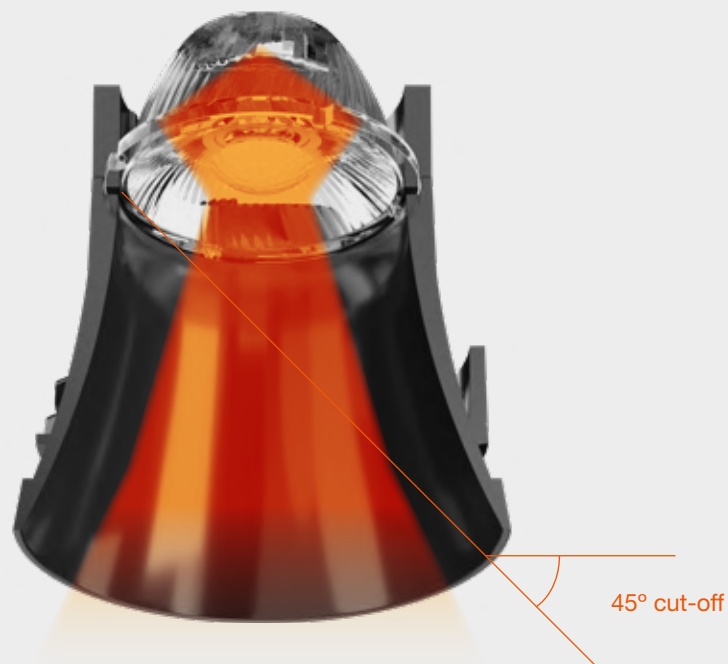

Lente a doppio fuoco sviluppata da FLOS appositamente per questo prodotto. Garantisce massimo controllo ottico e un'eccezionale omogeneità del fascio luminoso.

Dual-focus lens developed by FLOS specifically for this product. It ensures maximum optical control and exceptional light beam homogeneity.













La collezione Emi è disponibile in tre versioni: a soffitto, da terra e da tavolo. Questa varietà permette di adattare la luce di Emi sia agli spazi domestici che a quelli di *hospitality*.

The Emi collection is available in three versions: ceiling, floor and table. This variety helps adapt the light of Emi to spaces both at home and in hospitality.



L'uso ripetuto di un linguaggio simile in tutti i modelli permette di posizionare molteplici corpi luminosi dal linguaggio comune, che possono essere disposti nello spazio attraverso l'iterazione, l'allineamento e la simmetria. Questo rende Emi un nuovo tipo di illuminazione architettonica che può essere utilizzata in modo seriale, fornendo un design uniforme che si integra perfettamente nell'architettura circostante.

The repeated use of a similar style in all the models lets you position multiple luminaires with the same style, which can be arranged in a space through repetition, alignment and symmetry. This makes Emi a new type of architectural light that can be used as a series, providing a uniform design that fits in perfectly with the surrounding architecture.



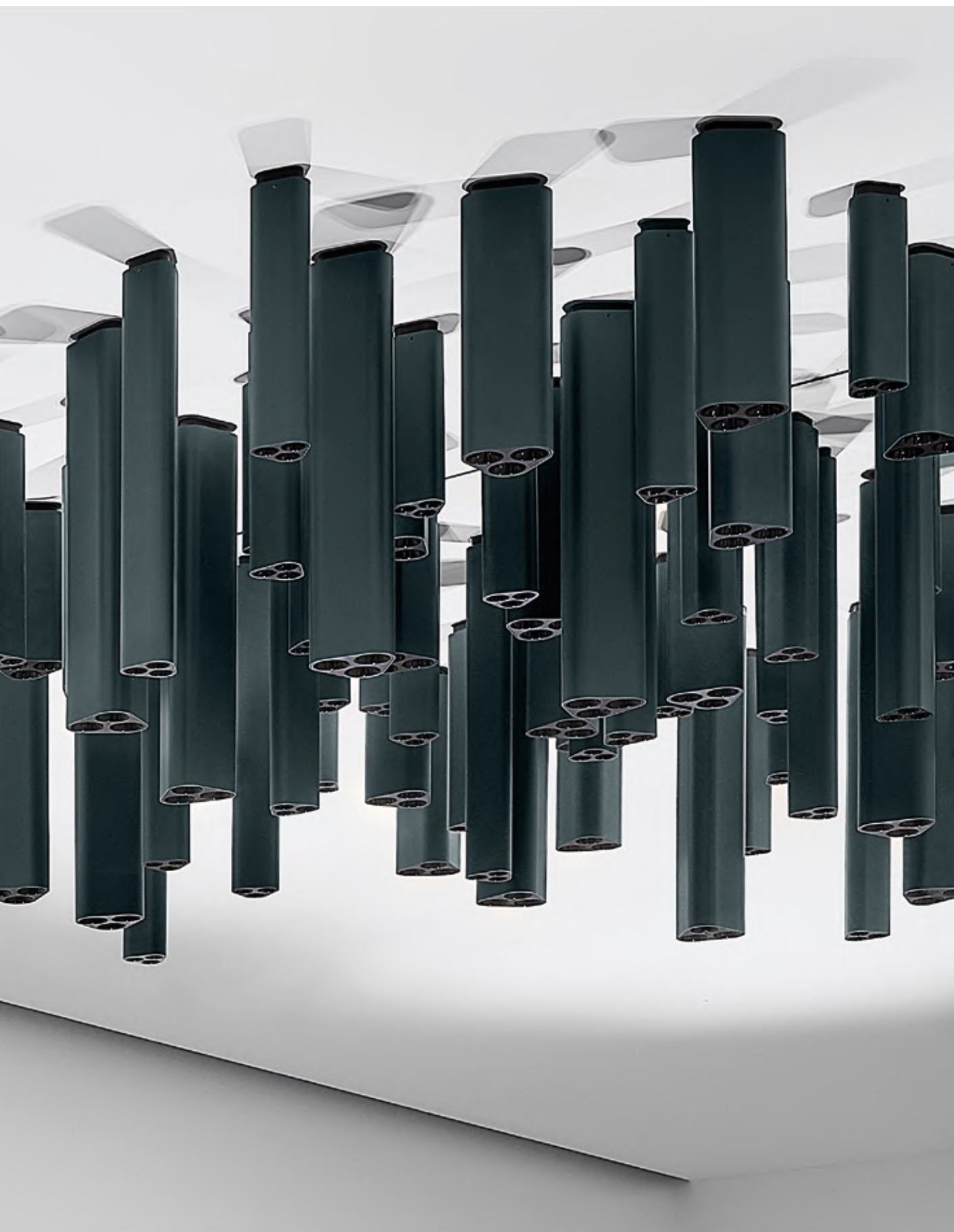

La palette di colori disponibili è stata commissionata specificatamente da Erwan Bouroullec per rivestire il design di EMI di quattro eleganti tonalità che donano una presenza magica e scultorea a questo "giunco architettonico".

The available colour palette has been commissioned specifically by Erwan Bouroullec to cover EMI's design in four stylish shades that add a magical, sculptural presence to this "architectural reed".







EMI dispone di *Spare Parts* per la manutenzione o la sostituzione dei suoi gruppi ottici. Ogni unità ottica può essere sostituita singolarmente per agevolare la manutenzione, mentre l'assenza di colle e saldature semplifica lo smontaggio e il corretto smaltimento delle singole parti alla fine della vita utile del prodotto.

EMI has *Spare Parts* for maintenance or replacement of its lens units. Every lens unit can be replaced individually to make maintenance easier, while the absence of glues and welding simplifies the disassembly and correct disposal of individual parts at the useful end of the product's life.





I modelli *Ceiling* sono disponibili con opzioni di regolazione Non Dimming, DALI, 1-10V e Mains Dimming. Le versioni *Floor* e *Table*, invece, si possono regolare con sensori capacitivi Touch Dimming posizionati nella parte superiore dello stelo centrale.

The *Ceiling* models are available with the following setting options Non Dimming, DALI, 1-10V and Mains Dimming. While the *Floor* and *Table* versions can be adjusted with Touch Dimming capacitive sensors in the top part of the central rod.

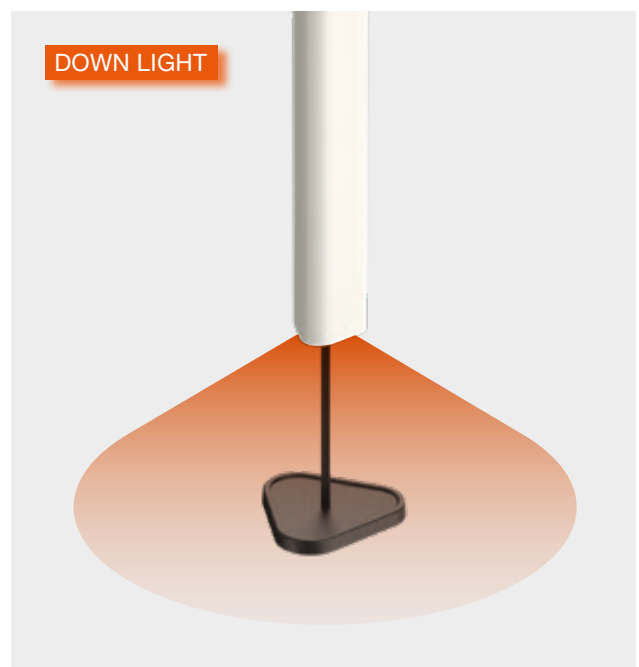





	Diverse opzioni di controllo per la regolazione di EMI.	Different control options for dimming EMI.
TOUCH DIMMING	Le versioni <i>Floor</i> e <i>Table</i> presentano una pulsantiera capacitiva integrata per il controllo della luce.	The <i>Floor</i> and <i>Table</i> versions have a built-in capacitive button panel to control the light.
DALI	Protocollo standard per l'integrazione con qualsiasi sistema di controllo.	Standard protocol for integration with any control system.
1-10V	Controllo remoto in broadcasting (dimmeraggio di tutti gli apparecchi di illuminazione in gruppo).	Broadcasting remote control (dimming of all the luminaires in a single group).



EMI CEILING
LARGE
H240

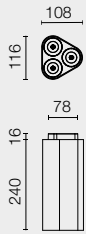

EMI CEILING
LARGE
H240



LED ARRAY
28W

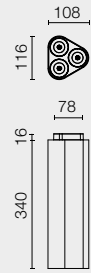

EMI CEILING
LARGE
H240

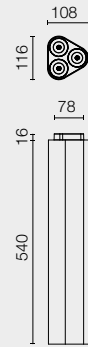

EMI CEILING
SMALL
H240



EMI CEILING
SMALL
H240



POWER LED
Up to 11W

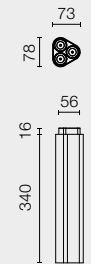

EMI CEILING
SMALL
H240

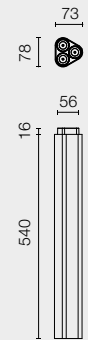

Spot



Medium



Flood



Wide Flood

EMI FLOOR

EMI TABLE



UP
LED ARRAY / 37W

UP
LED ARRAY / 31W

DOWN
POWER LED / 12,5W

DOWN
POWER LED / 12,5W

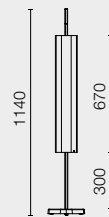
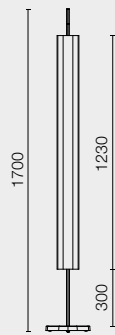

EMI CEILING

OW Off White

OW.XX All Off White

RY Deep Red

GY Deep Green

ZY Deep Blue



EMI TABLE & FLOOR

OW Off White

OW.XX All Off White

RY Deep Red

GY Deep Green

ZY Deep Blue



OBLIQUE

BB

L L

I I

Q Q

U U

E E

Oblique è una lampada rivoluzionaria: il fascio luminoso asimmetrico controllato emesso ha un UGR inferiore a 10 per una protezione antiriflesso eccezionale. Oltre al modello da tavolo (per applicazioni desktop), Oblique Floor svolge la sua funzione in modo analogo nelle applicazioni di illuminazione operativa per sedie da lettura, lounge chair e altri spazi, sia domestici che professionali.

Oblique is a revolutionary lamp: produces a controlled asymmetric light beam which UGR is lower than 10 for an exceptional anti-glare protection. Besides the table model (for desktop applications), Oblique Floor fulfills its function in an analogous way in task lighting applications for reading chairs, lounge chairs and other spaces, both domestic and professional.

OBLIQUE

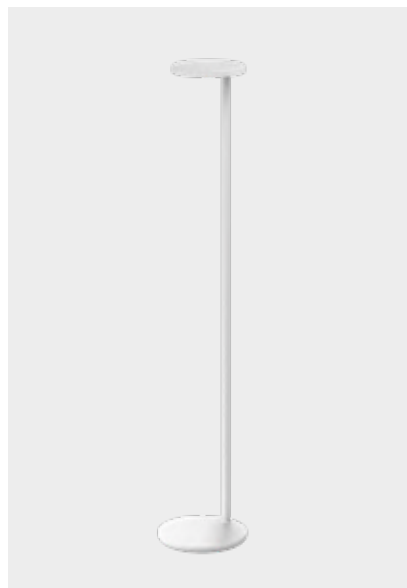



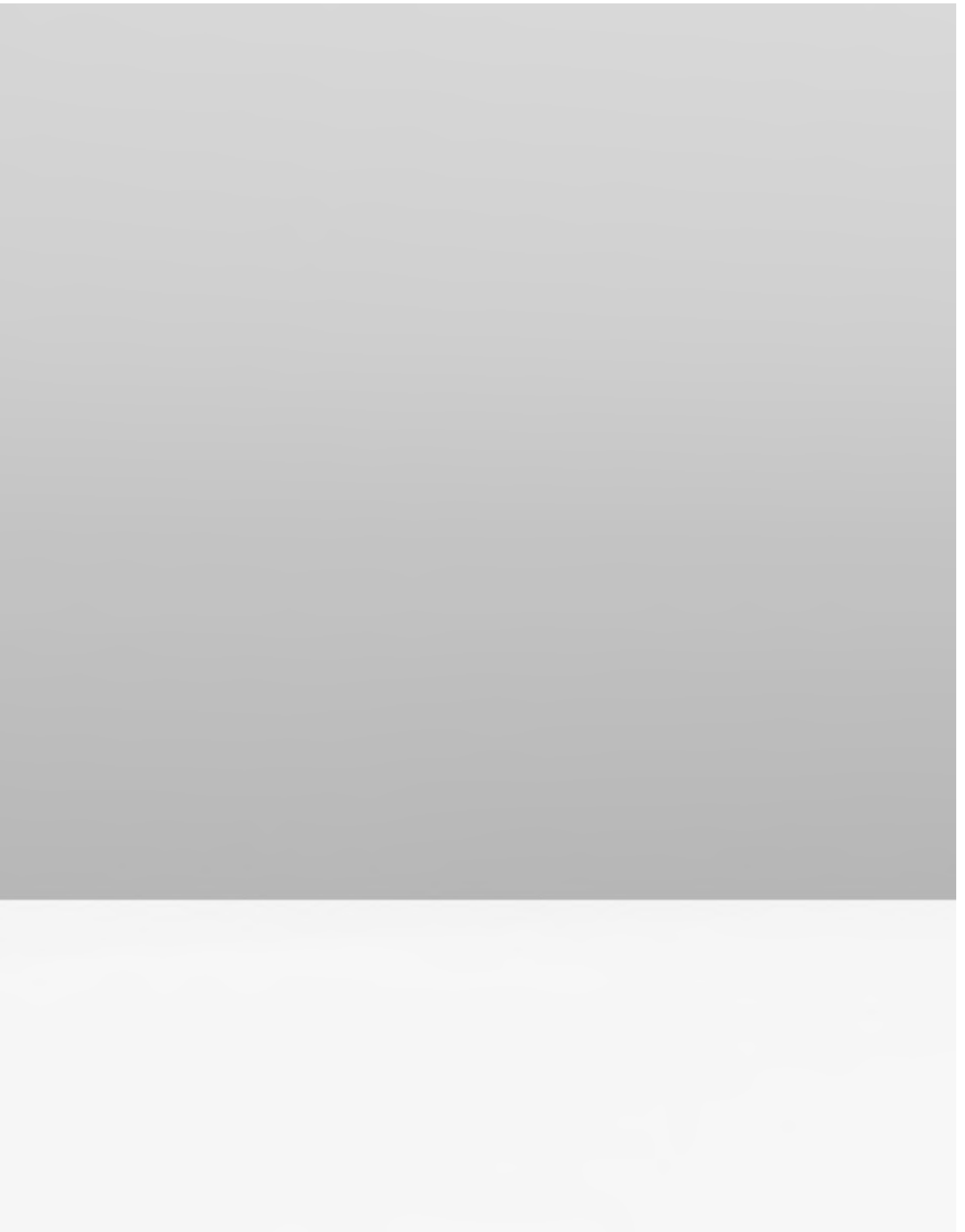

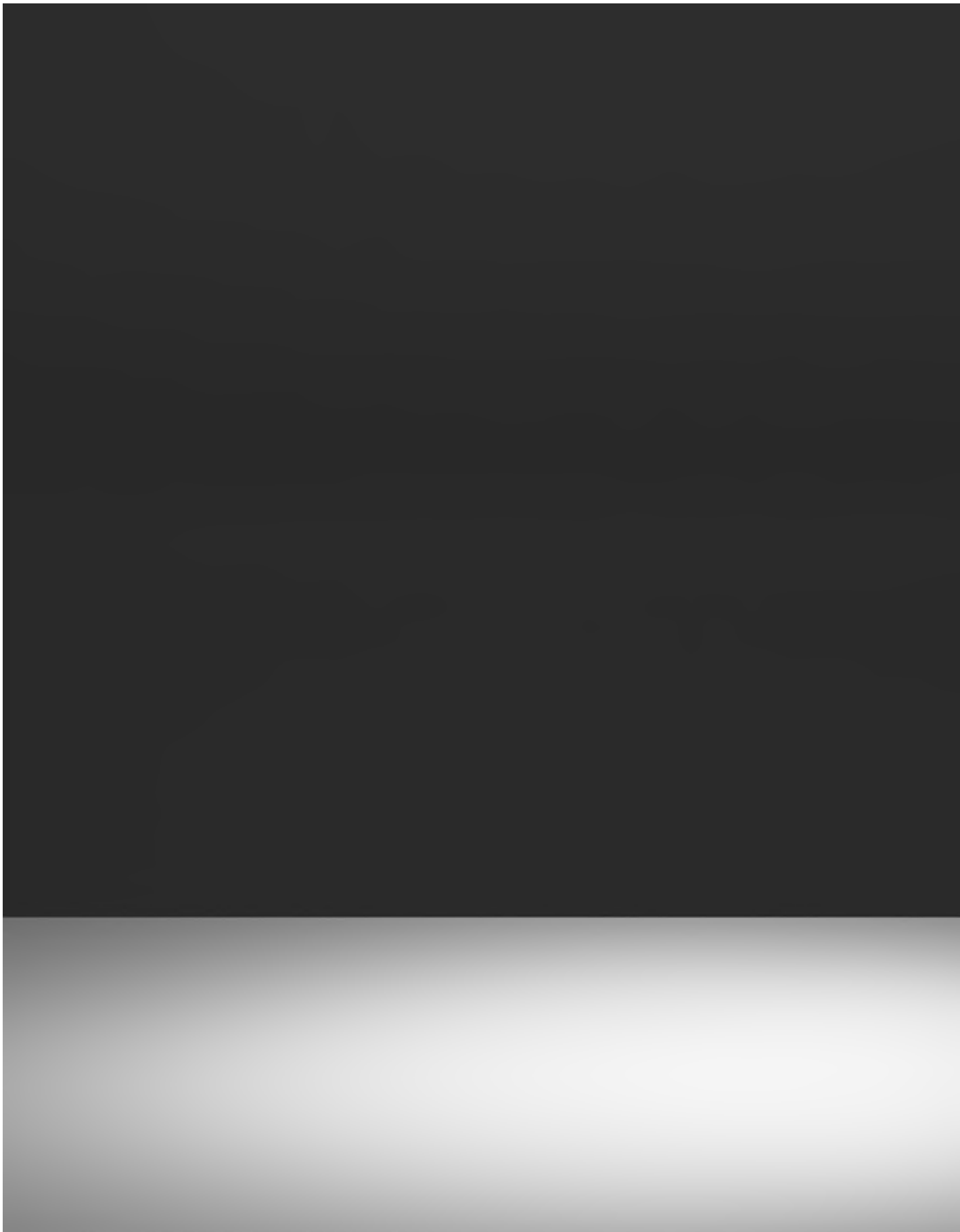







Oblique è il nuovo concetto di illuminazione da tavolo per un ambiente di lavoro. A differenza del tradizionale archetipo di lampada da scrivania con braccio articolato, Oblique è una lampada a struttura fissa, simile a una scultura. Un'ottica asimmetrica orienta il fascio di luce verso la zona di lavoro, permettendo così di conservare la stabilità della struttura, la purezza della sua forma e l'eleganza della sua presenza. L'avanguardia tecnica e la bellezza Flos vanno a braccetto.

La stessa filosofia ispira Oblique Floor: compie la stessa funzione ma come apparecchio di illuminazione ausiliare da abbinare a sedie da lettura, poltrone da salotto o altri ambienti, sia privati che professionali.

Oblique reformulates tabletop lighting in workspaces. In contrast to the traditional archetype of the desktop luminaire with an articulated arm, Oblique is an immobile piece, almost a sculpture. The light is projected towards the work area by an asymmetrical emission of the beam, maintaining the static nature of the piece, its formal purity and its elegant presence. Technical avant-garde and Flos beauty go hand in hand.

The same philosophy is followed by Oblique Floor, which fulfills its function in an analogous way in task lighting applications for reading chairs, lounge chairs and other spaces, both domestic and professional.



Il cuore di questa lampada è il frutto di una vera e propria sfida tecnologica. Racchiusi in uno spessore di soli 5 millimetri LED e lenti sono in grado di generare un fascio di luce estremamente potente e controllato.

The heart of this lamp is the result of a real technological challenge. The LEDs and lenses can generate an extremely powerful and controlled light beam from the inside of a just 5 mm thick space.



L'eccellenza del comfort: UGR inferiore a 10 per un'eccezionale protezione dall'abbagliamento, omogeneità nella distribuzione della luce e prestazioni in termini di lux conformi ai più severi standard del settore.

The excellence of comfort: UGR is lower than 10 for an exceptional anti-glare protection, homogeneity of light distribution and lux performance, in accordance to the strictest industry standards.







Lente ultrapiatta brevettata ad altissima efficienza 97%. Testa piana arrotondata per il minimo ingombro visivo.

Patented ultra-flat lens with a very high efficiency of 97%. Rounded flat head for minimum visual intrusion.

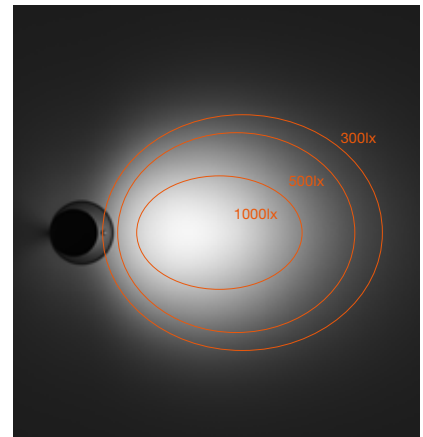

Base con sistema di ricarica wireless integrato. Permette di caricare lo smartphone liberando la scrivania da cavi e grovigli inestetici.

Base with integrated wireless charging system. Allows you to charge your smartphone while freeing your desk from unsightly crossed cables.



Oblique include sempre una porta USB-C integrata nella base per poter ricaricare dispositivi esterni.

Oblique always features a USB-C port integrated in the back of the base that can be used to charge additional devices.











Il pulsante capacitivo situato nella parte inferiore della testa dell'apparecchio offre un'interazione tattile di altissima qualità e consente il controllo del funzionamento e della regolazione di Oblique Floor.

The capacitive button at the bottom of the luminaire head offers the highest quality haptic interaction and allows control of the functioning and dimming of Oblique Floor.



Grazie all'altezza scelta e allo studiato angolo asimmetrico, Oblique Floor è un apparecchio di illuminazione perfetto per essere accostato a una poltrona in un angolo lettura.

Due to its chosen height and the studied asymmetrical angle of Oblique Floor, this is an ideal luminaire for reading lighting next to armchairs or reading chairs.

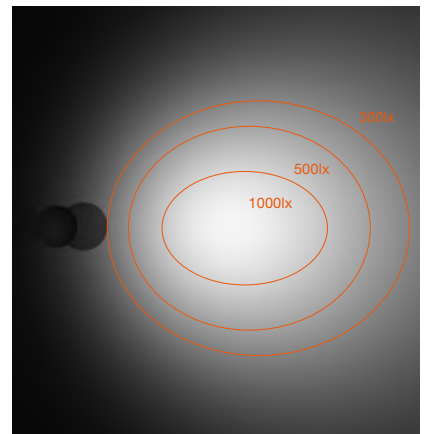

Collezione disponibile con differenti rifiniture, dal classico bianco, grigio e antracite ai più sofisticati toni pastello, pensati con il proposito di rendere più personalizzato l'ambiente di lavoro.

The collection is available in different finishes, from the classic white, grey and anthracite, to the most sophisticated pastel shades, specifically created to customize the working environment.

White / Grey / Rust / Brown / Anthracite / Salvia







OBLIQUE

OBLIQUE FLOOR



POWER LED
8W

POWER LED
8W

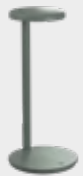
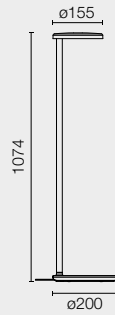
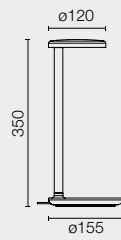

□ Bianco Opaco
Matt White

■ Grigio Lucido
Gloss Grey

■ Ruggine Opaco
Matt Rust

■ Marrone Opaco
Matt Brown

■ Antracite Opaco
Matt Anthracite

■ Salvia Lucida
Gloss Salvia



Asymmetric
Flood

DIVERSION
DIVER
DIVERSION
DIVERSION
DIVERSION
DIVERSION
DIVERSION
DIVER

Innovativo sistema del profilo miniaturizzato disegnato da Piero Lissoni per installazione a superficie e in sospensione, caratterizzato da una elevata flessibilità. Una guida multifunzione, che integra linee di luce e piccoli faretti, in grado di adattarsi a qualsiasi necessità architettonica e di creare innumerevoli forme geometriche.

Innovative minimized profile system designed by Piero Lissoni for surface and suspended installation characterized by an extreme flexibility. A multifunctional rail integrating light and small spots to adapt to any architectural need allowing to create countless geometries.

DIVERSION







I profili sono combinabili, permettendo di creare infinite configurazioni. Ogni dettaglio è stato studiato come parte di un programma completo. Il risultato è una soluzione di illuminazione perfettamente equilibrata, molto elegante e quasi invisibile.

Profiles can combine to obtain endless configurations. Every detail has been conceived as part of a complete program, the result is a perfectly balanced, highly stylish yet almost invisible lighting solution.



- 1 SURFACE PROFILE
- 2 SUSPENSION PROFILE
- 3 ATOM SPOT









Il segreto di Diversion per creare geometrie creative e versatili è un giunto di connessione unico patentato che permette di creare configurazioni a 360° con i profili, e di collegarne fino a 8. Una rivoluzione nell'illuminazione a sistema.

The key for Diversion to achieve creative and versatile geometries is a unique patented connection joint that allows the profiles to create 360° configurations, easily connecting up to 8 profiles together. A revolution in system lighting.

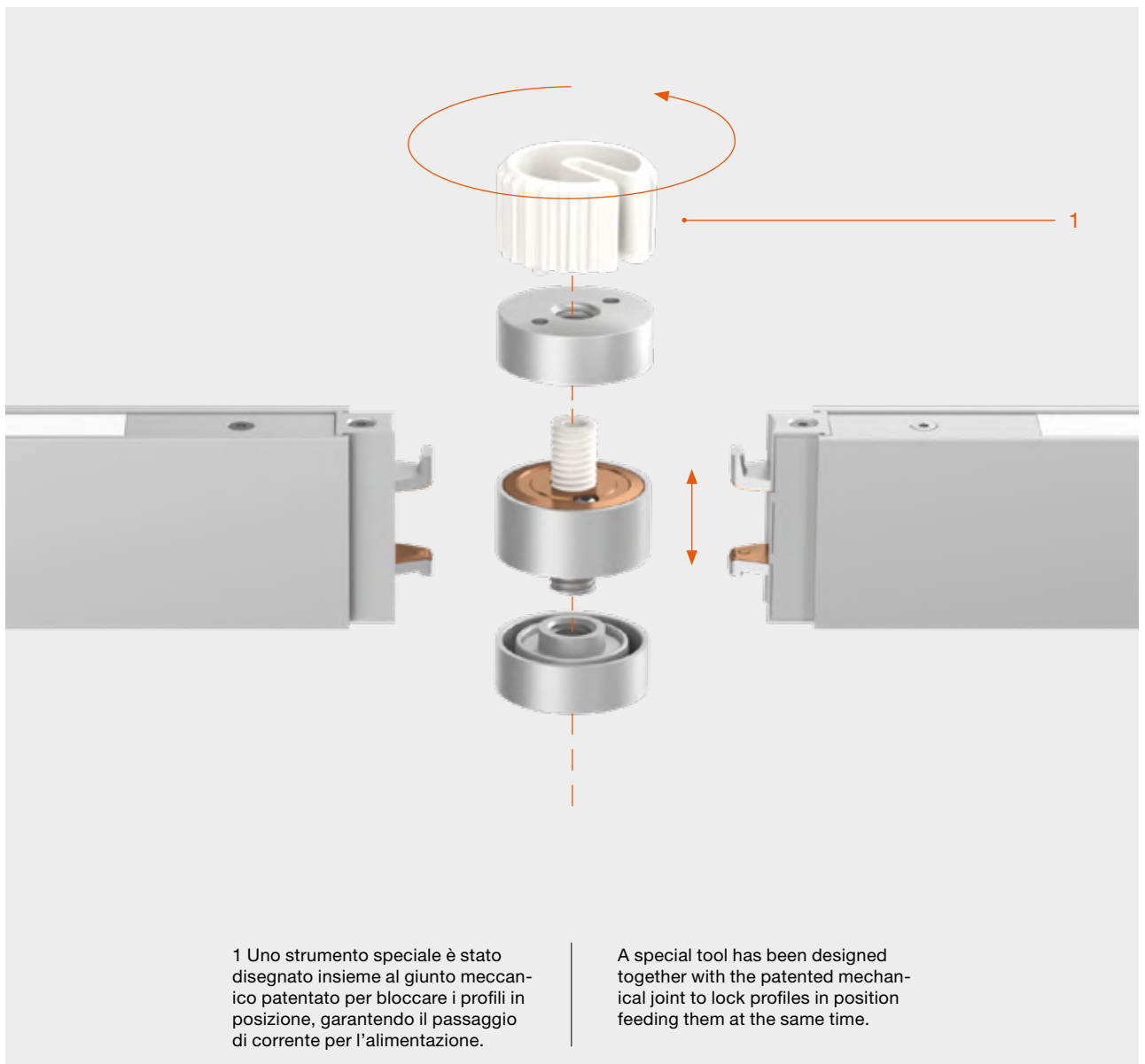

 A photograph showing a hand pointing to a very thin, horizontal lighting fixture mounted on a wall. The fixture is a long, narrow strip with a metallic finish.
 MINIMAL LINE

Una linea minimale di solo 34mm di spessore, ottenuta grazie a una estrema miniaturizzazione dei componenti elettronici ed ottici. Diversion offre una collezione completa di apparecchi di illuminazione per coprire ogni necessità.

A minimal line only 34 mm height, achieved through the extreme miniaturization of the electronics and the optical bodies. Diversion offers a complete collection of lighting tools for any need.

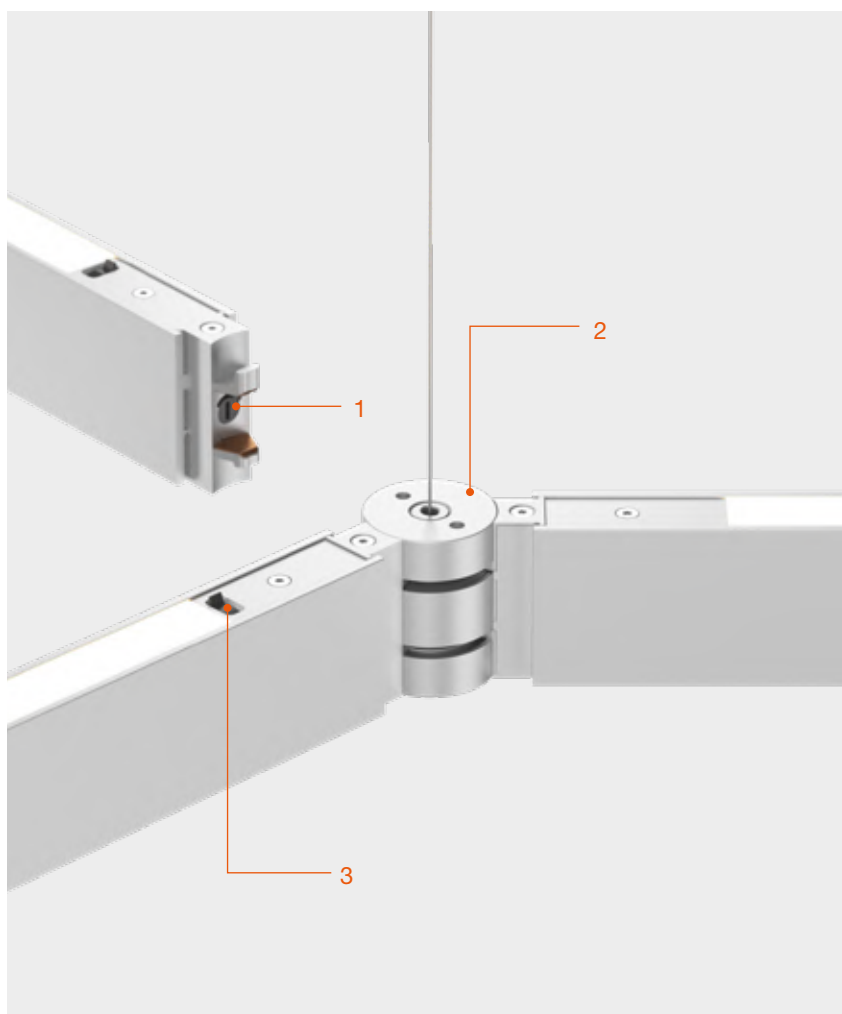

1 INTERRUPTORE INTEGRATO: ciascun profilo presenta un interruttore incorporato su entrambe le estremità. In questo modo è possibile bloccare il flusso di elettricità, permettendo di alimentare una struttura complessa partendo da vari punti di alimentazione.

INTEGRATED SWITCH: each single profile features an embedded switch at both ends. This allows to block the electricity flow being able to feed a complex structure from multiple feeding points.

2 GIUNTO PATENTATO: questo sistema speciale di giunzione mantiene i profili in posizione, permettendo di combinarne fino a 8 contemporaneamente. L'elettricità viene reindirizzata nei profili attraverso questo componente fondamentale.

PATENTED JOINT: the special joint system locks the profiles into position allowing to combine up to 8 of them together. Electricity comes into the profiles redirected through this key component.

3 SELETORE UPLIGHT: tutto il sistema è controllato simultaneamente. Tuttavia, i moduli con emissione di luce indiretta, sono completi con un interruttore integrato che permette di regolare la luce della parte superiore al 50%.

UPLIGHT SELECTOR: the entire system is controlled simultaneously. Nevertheless, modules featuring indirect light emission have a top switch to dim uplight to 50%.



I faretto, combinati con l'emissione diffusa ed omogenea proveniente da tutti i profili, consentono di cambiare radicalmente l'aspetto di qualsiasi scena, permettendo ai designer di giocare con contrasti e rilievi.

Spotlights combined with the soft even emission that comes from all profiles can radically change the appearance of almost any scene, allowing designers to play with contrasts and highlights.

UP&DOWN + SPOTS

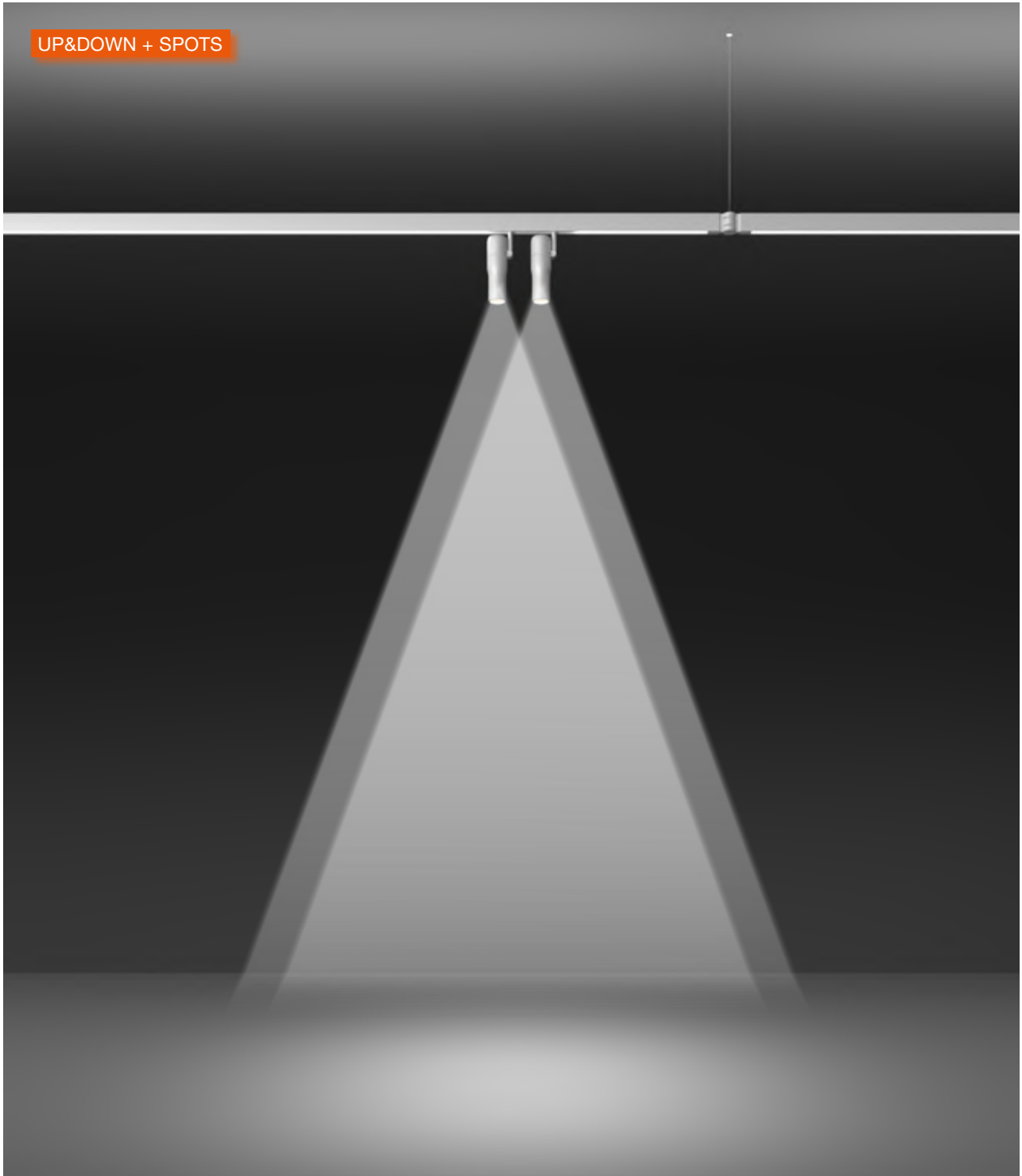

L'emissione diretta garantisce il massimo confort visuale, grazie alla posizione ad incasso profondo delle fonti LED che rimangono nascoste alla vista. L'emissione indiretta assicura un'esperienza visuale molto più gradevole nella stanza.

The direct emission ensures the utmost visual comfort thanks to a highly recessed position of the LED sources that remain hidden from view. The indirect emission provides an even more comfortable visual experience in the room.

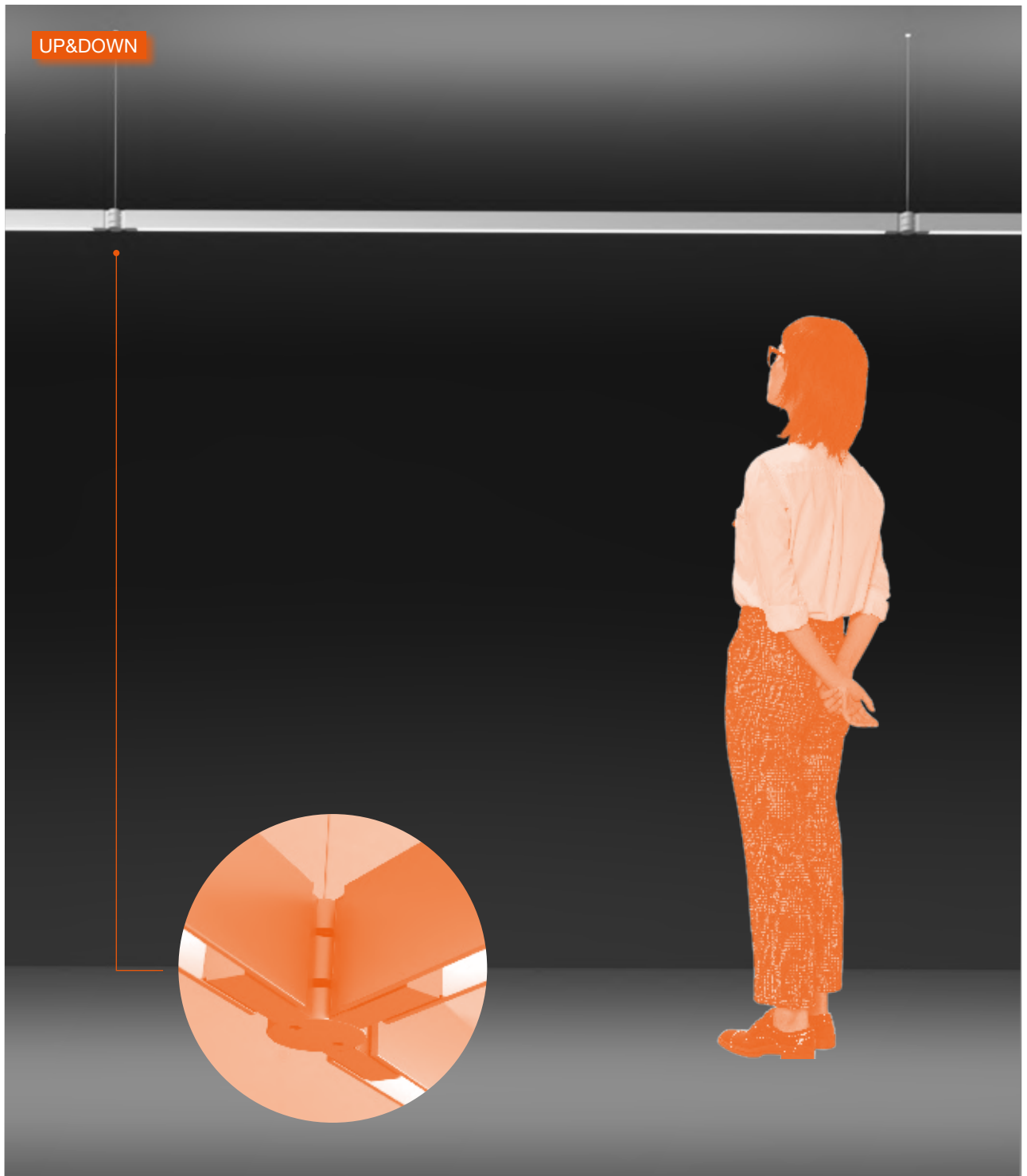

Diversion è disponibile in una gamma professionale completa, composta da due profili diversi che permettono un'emissione diretta o diretta/indiretta. La lunghezza massima disponibile per un singolo profilo è di 2500 mm. Entrambe le versioni possono essere combinate con illuminazione d'accento, grazie ad una soluzione speciale che permette di integrare fino a due faretti Atom.

Diversion is available in a complete professional range including two different profiles that feature direct emission or direct/indirect emission. Maximum length available for a single profile is 2500 mm. Both versions can also combine accent lighting thanks to a dedicated solution allowing to integrate up to two Atom spots.

PROFILES + SPOTS

2500 mm



2000 mm



1500 mm



1000 mm



PROFILES

2500 mm



2000 mm

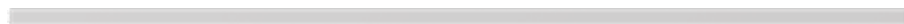

1500 mm

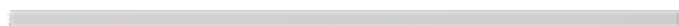

1000 mm







CONFIGURAZIONE

Grazie alla versatilità del sistema è possibile realizzare praticamente qualsiasi configurazione. Da composizioni geometriche pure a forme libere, combinando sia moduli a superficie che in sospensione, per ottenere una configurazione 3d accattivante.

CONFIGURATION

Almost any kind of layout is achievable thanks to the versatility of the system. From pure geometric compositions up to free shapes, combining both Surface and Suspension modules to obtain an eye-catching 3D configuration.

EXAMPLE NO.1

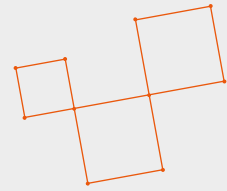

8 x Suspension Profile 1500mm
4 x Suspension Profile 1000mm

EXAMPLE NO.2

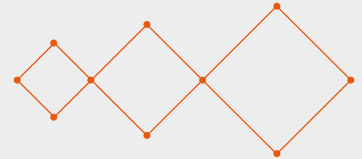

4 x Suspension Profile 2000mm
4 x Suspension Profile 1500mm
4 x Suspension Profile 1000mm

EXAMPLE NO.3

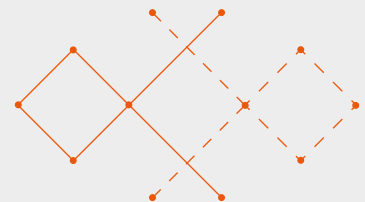

1 x Suspension Profile 2500mm
2 x Suspension Profile 1000mm
1 x Surface Profile 2000mm
2 x Surface Profile 1500mm
1 x Surface Profile 1000mm

EXAMPLE NO.4

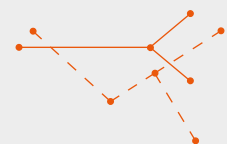

2 x Suspension Profile 2500mm
4 x Suspension Profile 1500mm
2 x Surface Profile 2500mm
4 x Surface Profile 1500mm

Suspension version ———

Surface version - - - - -



Tutti i profili Diversion predisposti per integrare un'illuminazione d'accento consentono l'installazione di due proiettori Atom. L'illuminazione d'accento ha una posizione fissa nel profilo, per mantenere la struttura in equilibrio e garantire una massima pulizia visiva in tutte le configurazioni.

All Diversion profiles preset to integrate accent lighting allow to install up to two Atom projectors. Accent lighting has a fixed positioning within the profile to balance the structure and assure maximum visual cleaning in all configurations.





	Diverse opzioni di controllo per la regolazione di Diversion, tutte disponibili per installazione a incasso o a superficie.	Different control options for dimming Diversion, all available for remote recessed or surface installation.
PUSH DIMMING	Controllo mediante un dispositivo di regolazione.	Control trough a simple pushbutton.
DALI	Protocollo standard per l'integrazione con qualsiasi sistema di controllo.	Standard protocol for integration with any control system.
1-10V	Controllo mediante un dispositivo di regolazione.	Track control trough a dimmer device.
CASAMBI	Controllo wireless attraverso l'App FLOS Control®, disponibile per dispositivi iOS e Android.	Track wireless control trough the FLOS Control® app, available iOS and Android devices.

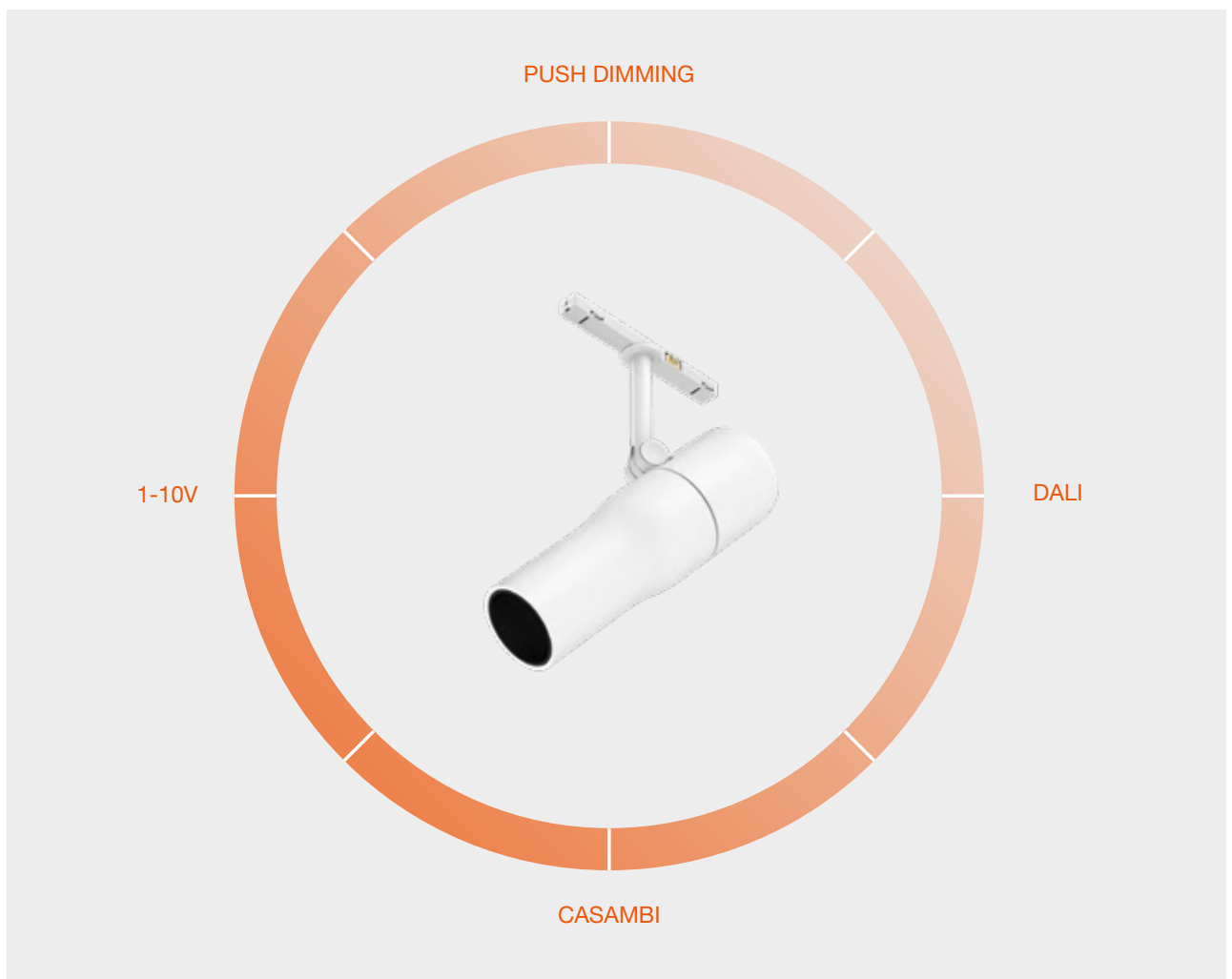

LIGHT MODULES STRUCTURES

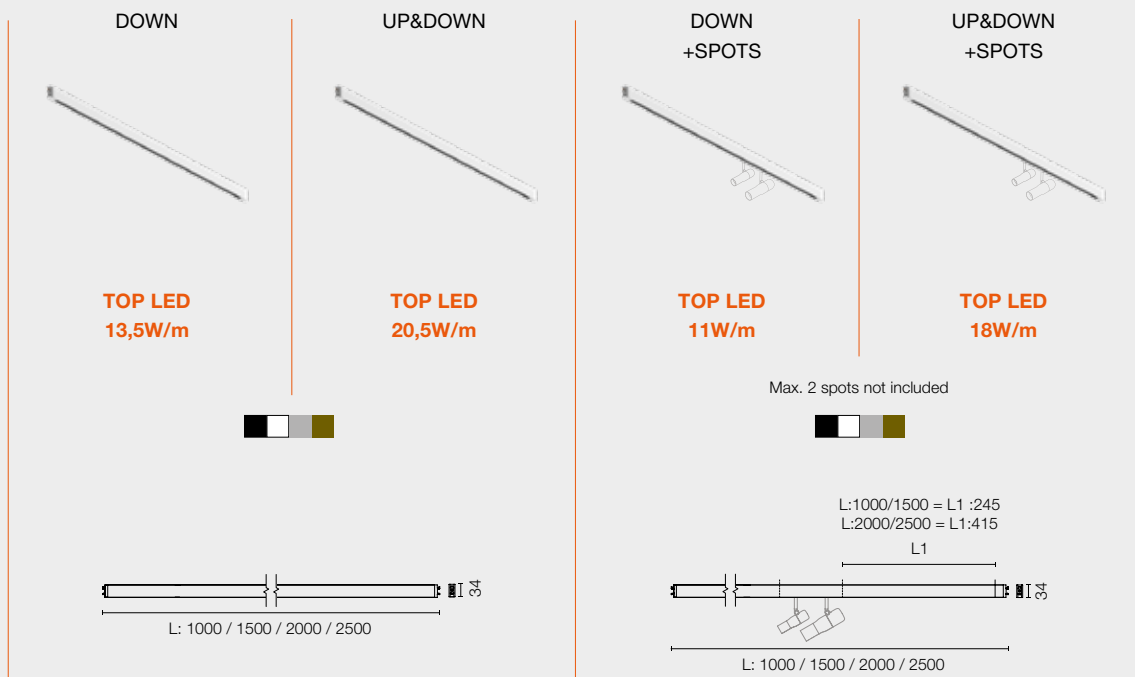

LIGHT MODULES

ATOM 90

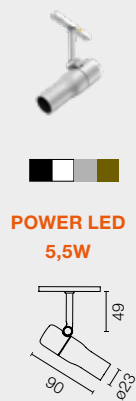

ATOM 120

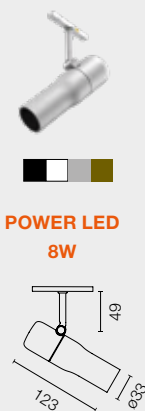

Spot



Medium

LIGHT MODULES

□ 40 Bianco
40 White

■ 1A Anodic Ice
1A Anodic Ice

■ 14 Nero
14 Black

■ CZ Bronzo
CZ Bronze



FLOS
CONTROL BY CASAMBI



ZERO TRACK

ZERO TRAC

ZERO TRA

ZERO TR

ZERO T

ZERO

ZER

ZE

Z

Sistema composto da un profilo a bassa tensione (24V) per installazione a superficie che, grazie alla sua miniaturizzazione e alla semplicità geometrica, crea un effetto ad incasso soffitto/parete. Zero Track & Pro unisce la facilità di applicazione di una struttura a superficie all'eleganza estetica di un'installazione ad incasso.

Surface low voltage (24V) profile with a sleek, streamlined design to create a visual-flush solution for walls and ceilings. Zero Track & Pro combines the easy application of a surface structure with the sleek elegance of a flush installation.

ZERO TRACK & PRO





Restaurant Hert, Belgium





1. Blind End
2. Linear Conector Feed
3. Staight Connector
4. X Connector Feed
5. 90° Corner Feed
6. T Connector Feed
7. Power Supply Surface End
8. Power Supply Surface Middle
9. Inner Corner
10. Live End Feed

La perfetta integrazione permessa dall'architettura di Zero Track & Pro dà altresì spazio ad una notevole versatilità di percorsi e linee grazie ai giunti a "T", "X", "L" e angoli interni diedri per cambi di quota soffitto-parete, parete-parete e viceversa.

Perfect integration with the Zero Track & Pro architecture also enables considerable versatility with tracks and lines with T, X and L joints, plus interior angles for ceiling-wall and wall-wall plane variations.

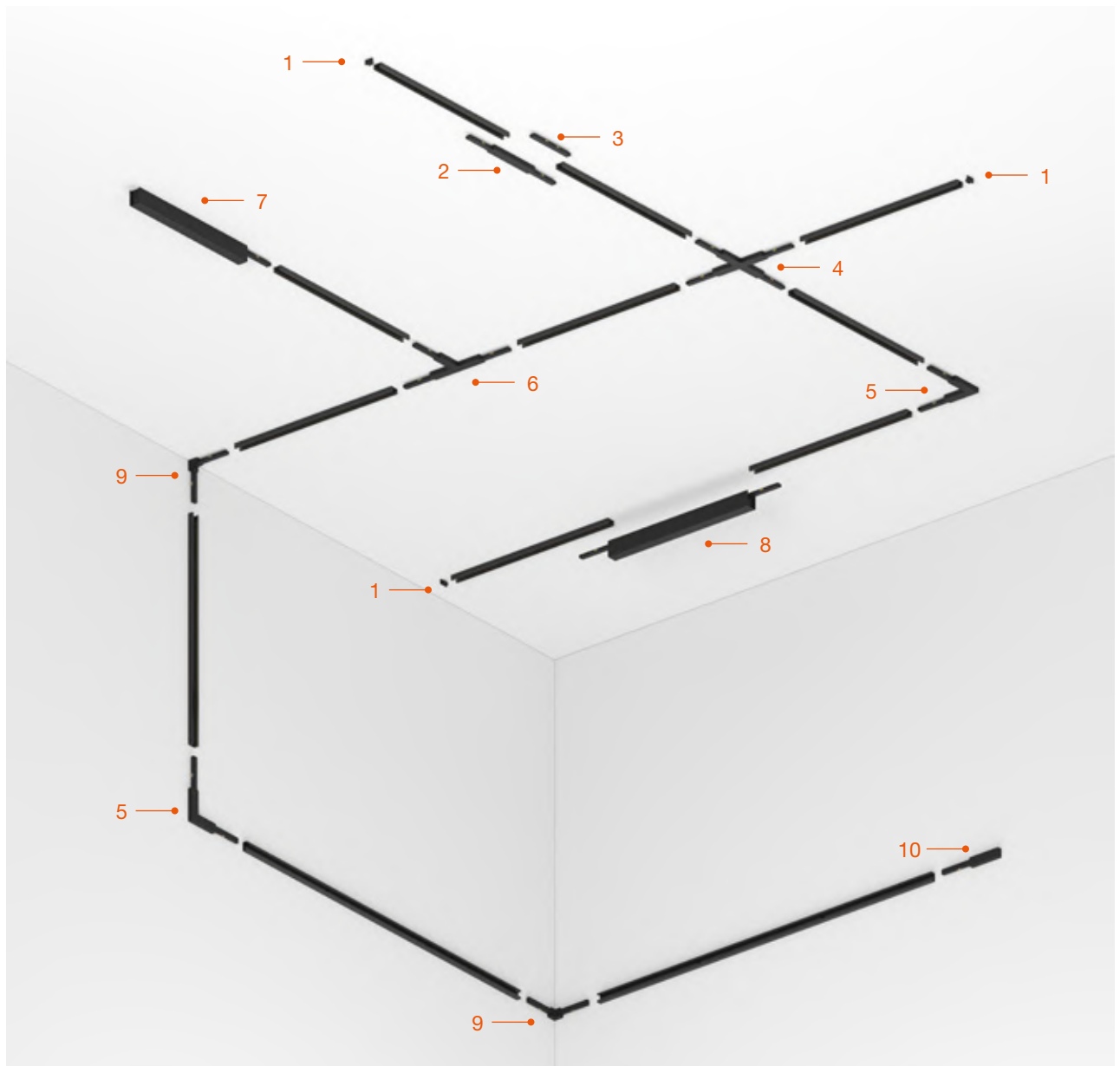





A livello visivo, le dimensioni di Zero Track & Pro ne rendono la tridimensionalità quasi invisibile alla normale distanza da cui si osserva questo tipo di prodotto una volta installato. Pertanto, esteticamente Zero Track & Pro risulta un profilo trimless.

The dimensions of Zero Track & Pro ensure that visually its three-dimensionality is almost not perceived at the normal distance at which this type of product is installed. The Zero Track & Pro solution therefore looks like a trimless profile.

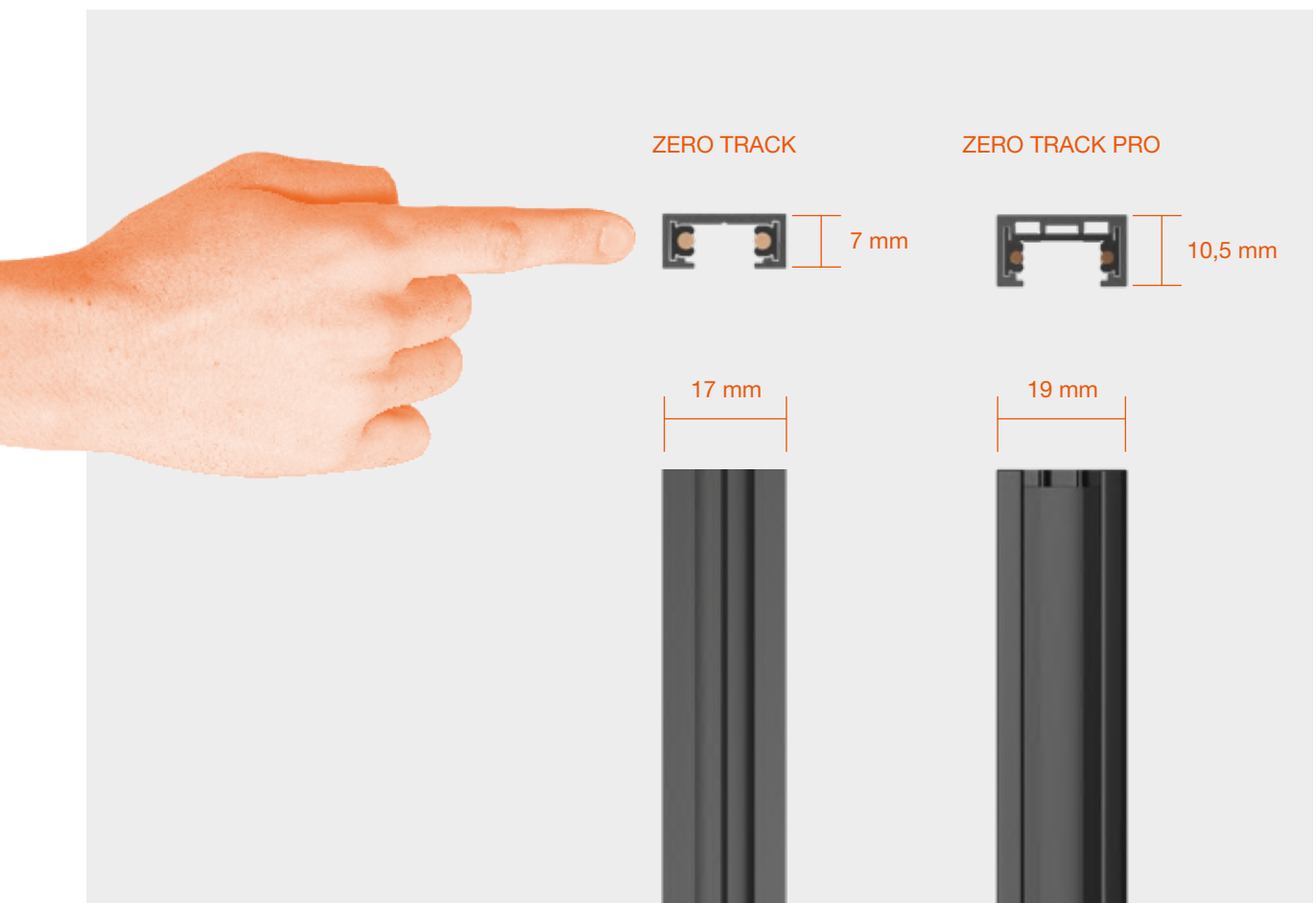



ZERO TRACK & PRO SYSTEM



1 BUS* per la trasmissione dei dati.
Data transmission BUS*.

2 Conduttori elettrici a bassa tensione.
Low voltage electric conductors.

3 Elettronica di controllo wireless Casambi,
integrata nell'apparecchio. (* Consultare i modelli).
Casambi wireless control electronics,
incorporated in the light. (* See models).

Nella sua minuscola sezione, Zero Track & Pro dispone di conduttori elettrici e BUS* per la trasmissione dei dati. Questo aspetto lo rende una soluzione compatibile con i sistemi di controllo più esigenti per gestire gli apparecchi singolarmente (punto a punto), sia con protocollo DALI* sia tramite controllo wireless Casambi. Inoltre, è possibile disporre di gestione in modalità broadcast 1-10V*.

Zero Track Pro features a small section with electric conductors and data transmission BUS*. The result is a compact control solution with the most selective control system for managing lights individually (point to point) via DALI* protocol or wireless Casambi control. Similarly, 1-10V* broadcast control is possible.

TRADITIONAL SYSTEM

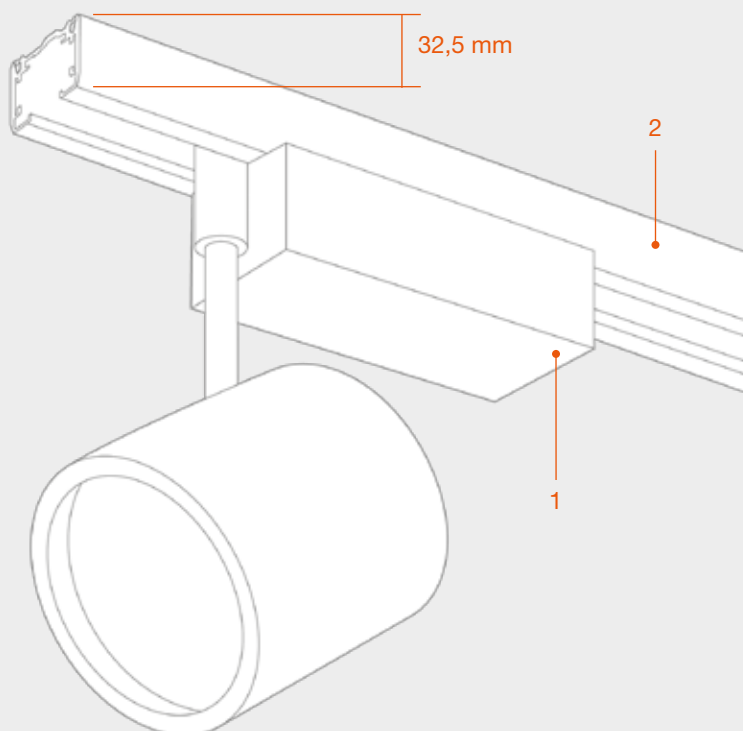

1 Motore Tradizionale.
Traditional Engine.

2 Guida Tradizionale.
Traditional Track.

* Solo Zero Track Pro / * Only Zero Track Pro

Oltre alla versione di alimentazione con apparecchio remoto, Zero Track & Pro, in alternativa, può alimentare il sistema tramite un'apparecchiatura a vista annessa al binario, grazie alla "Scatola di alimentazione a superficie", disponibile come accessorio.

In addition to the remote power supply option, Zero Track & Pro features an alternative with the system powered from a surface power supply box offered as an accessory.







FIND ME



La gamma di apparecchi Zero Track & Pro include i faretti di Find Me, disegnati da Jorge Herrera. Questo design innovativo è disponibile in tre grandezze, tra cui il nuovo Find Me 0, che offre i design minimali della fortunata collezione Find Me.

The Zero Track & Pro luminaire range includes the Find Me spots designed by Jorge Herrera. This innovative design embraces three different sizes, including the new Find Me 0, which brings the minimal designs of the successful Find Me collection.

ATOM



Con lo squisito tocco di design di Piero Lissoni, il sistema Zero Track & Pro offre Atom: una serie di faretti in tre grandezze, perfetti per illuminazione d'accento. Il sistema Zero Track & Pro offre il massimo livello di comfort grazie alla posizione profonda dell'ottica e agli accessori di schermatura inclusi in ogni faretto, completati da un apparecchio di forma rotonda per un'illuminazione generale.

With the exquisite design touch of Piero Lissoni, the Zero Track & Pro system offers Atom: a series of spotlights in three different sizes, perfect for an accent lighting. The Zero Track & Pro system provides the highest comfort level thanks to the deep position of the optic and the screening accessories included with each spot, completed by a round shape luminaire for a general lighting.









La tecnologia ad alto comfort visivo e lenti bifocali della famiglia Light Shadow è presente anche in Zero Track Pro con le misure 30 e 45 di Light Shadow Spot.

The visual high-comfort technology and dual-focus lenses in the Light Shadow range are also available with Zero Track Pro Light Shadow Spot 30 and 45.



Con Magic Stick, disegnati da Jorge Herrera, e le linee di luce (integrate in Zero Track & Pro) si ottiene un effetto di illuminazione generale diffusa ed è possibile creare effetti di "illuminazione grafica".

With Magic Stick, designed by Jorge Herrera, and lines of light (incorporated in Zero Track Pro) general diffuse lighting can be achieved, in addition to graphic lighting effects.

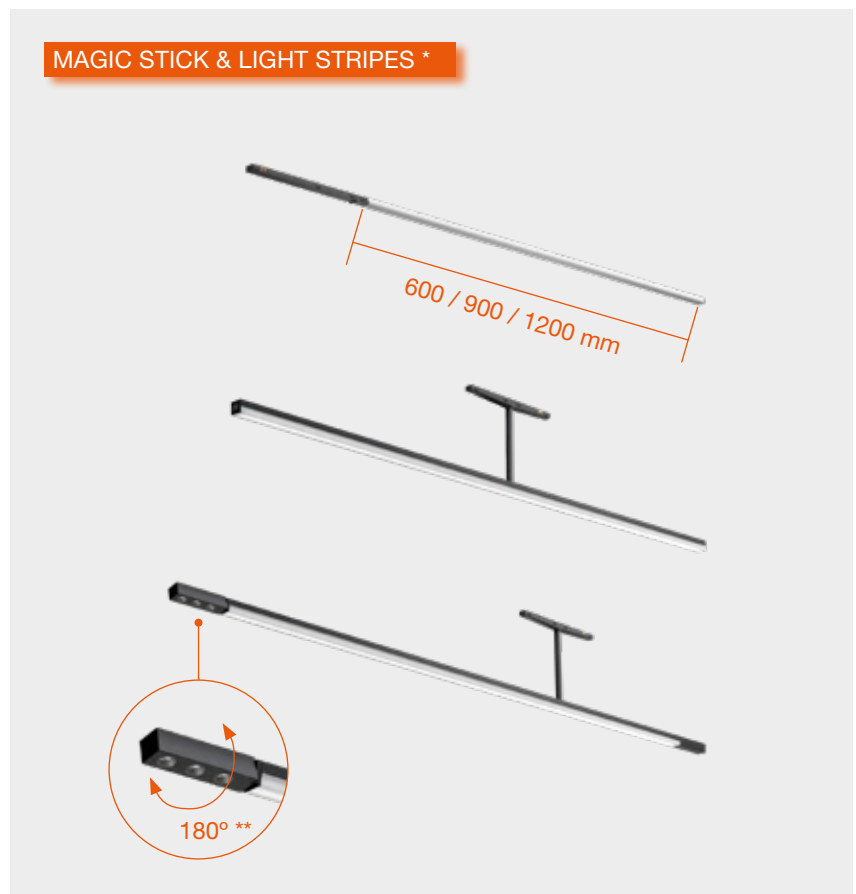

** Set integrato di tre faretti.
Illuminazione basculante e d'accento.

** Integrated three-spot set.
Accent lighting and tilting.

* Solo Zero Track Pro / * Only Zero Track Pro



Grazie a Magic Stick, Zero Track Pro offre un'esperienza unica che trasforma qualsiasi spazio, grazie alla sua capacità di creare composizioni visive audaci e incomparabili. Gli esempi presentati rappresentano solo alcune delle sue molteplici possibilità.

Thanks to Magic Stick, Zero Track Pro provides a unique experience that transforms any space, through its ability to create bold and unparalleled visual compositions. The examples presented only represent some of its many possibilities.

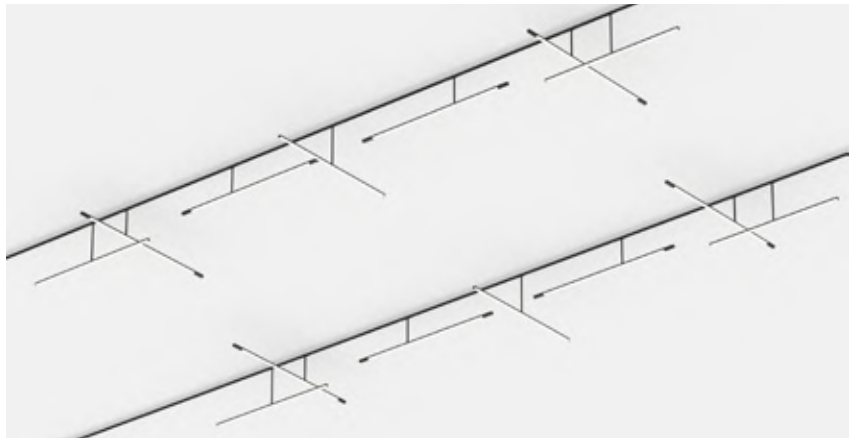

	Diverse opzioni di controllo per la regolazione di Zero Track & Pro, tutte disponibili per installazione a incasso o a superficie.	Different control options for dimming the Zero Track & Pro, all available for remote recessed or surface installation.
DALI *	Protocollo standard per l'integrazione con qualsiasi sistema di controllo.	Standard protocol for integration with any control system.
1-10V BROADCAST *	Controllo mediante un dispositivo di regolazione.	Track control through a dimmer device.
CASAMBI	Controllo wireless attraverso l'App FLOS Control®, disponibile per dispositivi iOS e Android.	Track wireless control through the FLOS Control®, available iOS and Android devices.

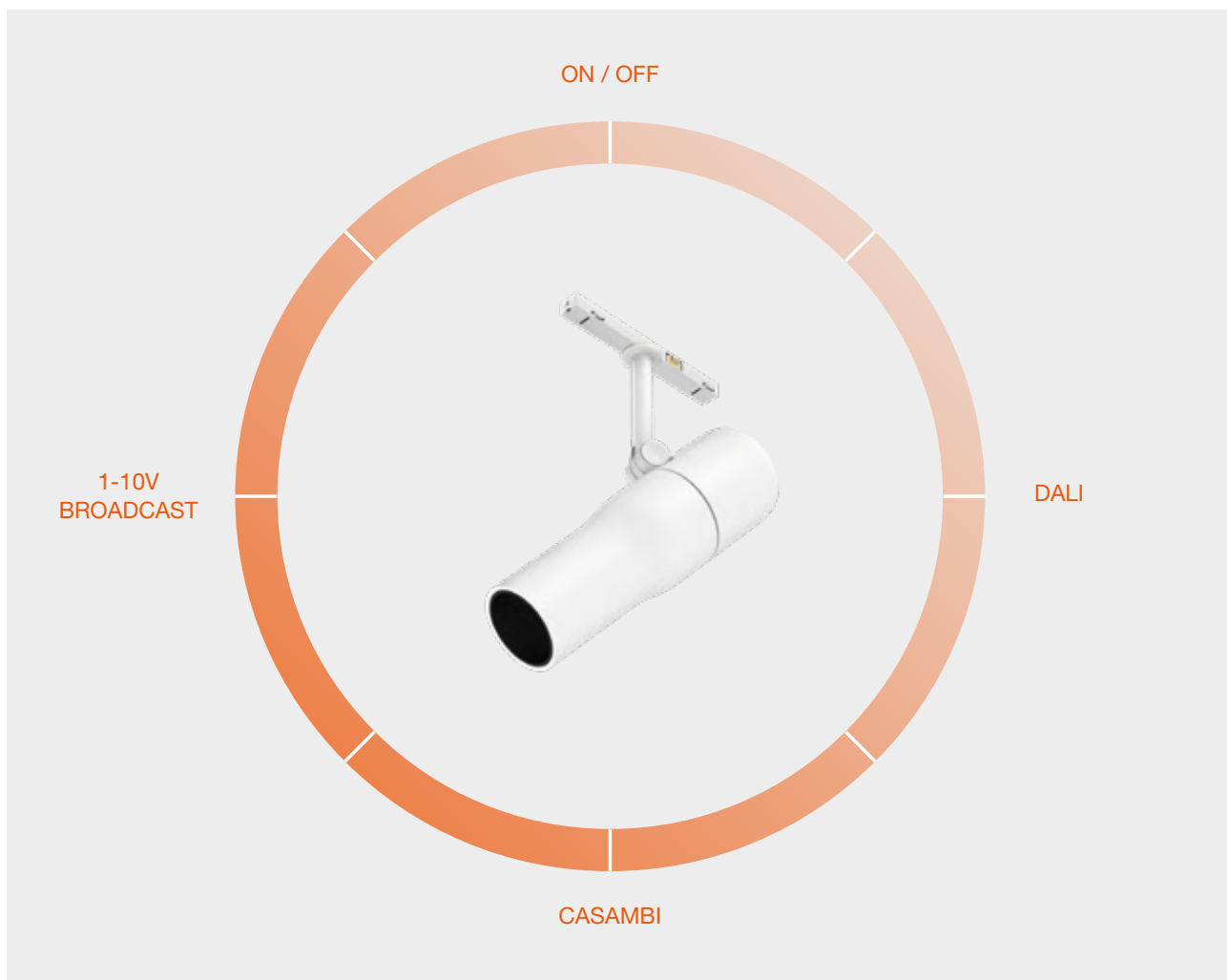



LIGHT MODULES

LIGHT STRIPE
600 / 900 / 1200



TOP LED
Up to 13,5W

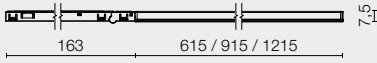

MAGIC STICK



POWER LED
10,5W

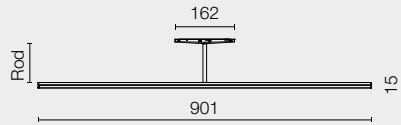

Rod: 100 / 145 / Custom

MAGIC STICK
ASYMMETRIC



POWER LED
12W

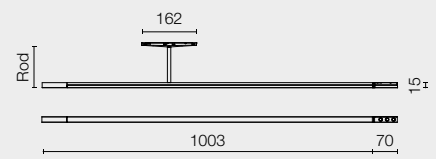

Rod: 100 / 145 / Custom

FIND ME 0



POWER LED
3,5W

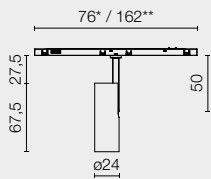

FIND ME 1



POWER LED
5,5W

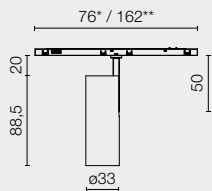

FIND ME 2



POWER LED
10,5W

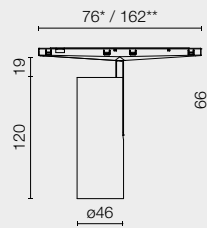

FIND ME 1
SUSPENSION



POWER LED
5,5W

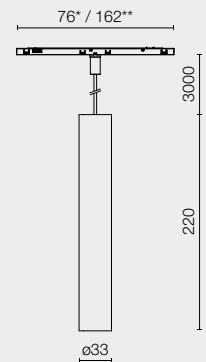

* Non Dimmable, Casambi / ** Dali, 1-10V



Spot



Medium



Flood



Wide Flood

LIGHT MODULES

LIGHT SHADOW
SPOT 30



POWER LED
4,7W

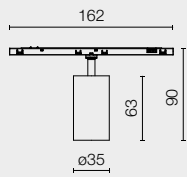

LIGHT SHADOW
SPOT 45



LED ARRAY
11W

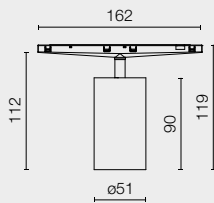

ATOM 90



POWER LED
5,5W

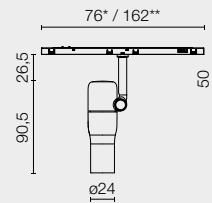

ATOM 120



POWER LED
8W

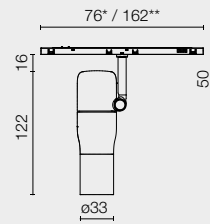

ATOM 200



TOP LED
10,5W

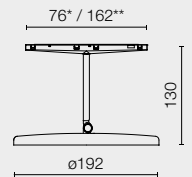

* Non Dimmable, Casambi / ** Dali, 1-10V

40 Bianco
40 White

14 Nero
14 Black

EQ Rame Spazzolato
EQ Brushed Copper

ER Acciaio Spazzolato
ER Brushed Steel

ES Bronzo Spazzolato
ES Brushed Bronze



L: 1000 / 2000 / 3000



LIGHT MODULES

FIND ME 0



POWER LED
3,5W

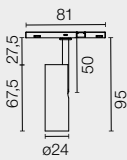

FIND ME 1

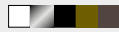

POWER LED
5,5W

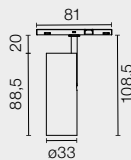

FIND ME 2



POWER LED
10,5W

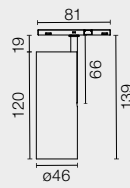

FIND ME 1
SUSPENSION



POWER LED
5,5W



ATOM 90



POWER LED
5,5W

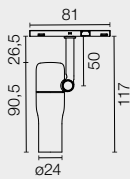

ATOM 120



POWER LED
8W

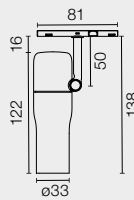

ATOM 200



POWER LED
10,5W

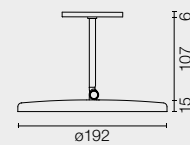

Spot



Medium



Flood

SURFACE PROFILES

□ 40 Bianco
40 White

◻ 06 Cromo
06 Chrome

■ 14 Nero
14 Black

■ CZ Bronzo
CZ Bronze

■ 18 Deep brown
18 Deep brown

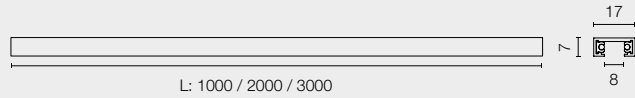

L: 1000 / 2000 / 3000

THE MICRO THE MICRO THE MICRO THE MICRO

RUNNING MAGNET

THE MICRO THE MICRO THE MICRO THE MICRO

RUNNING MAGNET

THE MICRO THE MICRO THE MICRO THE MICRO

RUNNING MAGNET

THE MICRO THE MICRO THE MICRO THE MICRO

RUNNING MAGNET

THE MICRO THE MICRO THE MICRO THE MICRO

RUNNING MAGNET

THE MICRO THE MICRO THE MICRO THE MICRO

RUNNING MAGNET

THE MICRO THE MICRO THE MICRO THE MICRO

RUNNING MAGNET

THE MICRO THE MICRO THE MICRO THE MICRO

RUNNING MAGNET

Innovativo programma di strutture ultraminiaturizzate in versione a incasso e superficie. Compatibile con un'ampia gamma di soluzioni di illuminazione professionali mediante fissaggio magnetico. La soluzione definitiva per l'illuminazione espositiva.

Innovative program of ultra-miniaturized structures in recessed and surface versions. Compatible with a wide range of professional lighting solutions by means of magnetic fixing. The ultimate solution for exhibition lighting.

THE MICRO RUNNING MAGNET







La quintessenza della luce integrata, ottenuta grazie ad un profilo di soli 5mm che permette la totale integrazione di micro apparecchi progettati per fondersi con la struttura fin quasi a scomparire.

The quintessence of integrated light, obtained thanks to a profile of only 5 mm that allows the total integration of micro-devices designed to be combined with the structure until they disappear almost completely.



1 RECESSED

2 SURFACE



Le incredibili dimensioni ridotte del profilo che caratterizza il programma esaltano la flessibilità della luce e il suo rapporto con l'architettura. L'installazione dei corpi illuminanti avviene tramite supporto magnetico all'interno del profilo per una semplicità d'uso senza eguali.

The incredibly small profile size that characterizes the program enhances the light's flexibility and its relationship with the architecture. The lighting bodies are installed by means of a magnetic support inside the profile, providing an unparalleled ease of use.

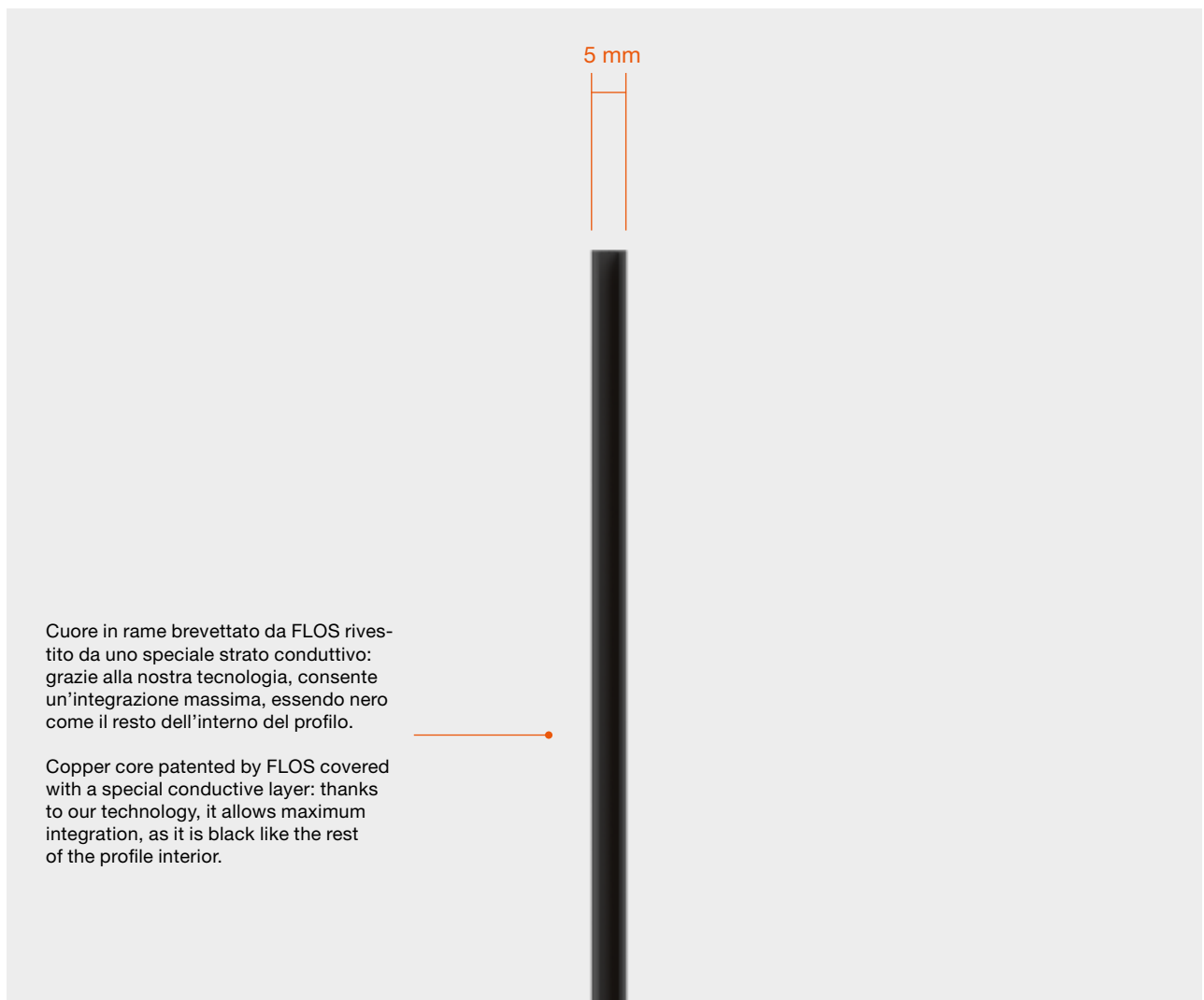



Sergio Rossi, London



Fissaggio magnetico degli apparecchi di illuminazione, che consente la manipolazione a caldo. I corpi illuminanti si possono spostare da accesi ottenendo enorme flessibilità e adattabilità della configurazione in qualunque momento.

Magnetic fixing of the luminaries, which allows hot handling. The lighting bodies can be moved when they are still on, achieving enormous flexibility and adaptability in the configuration at any time.

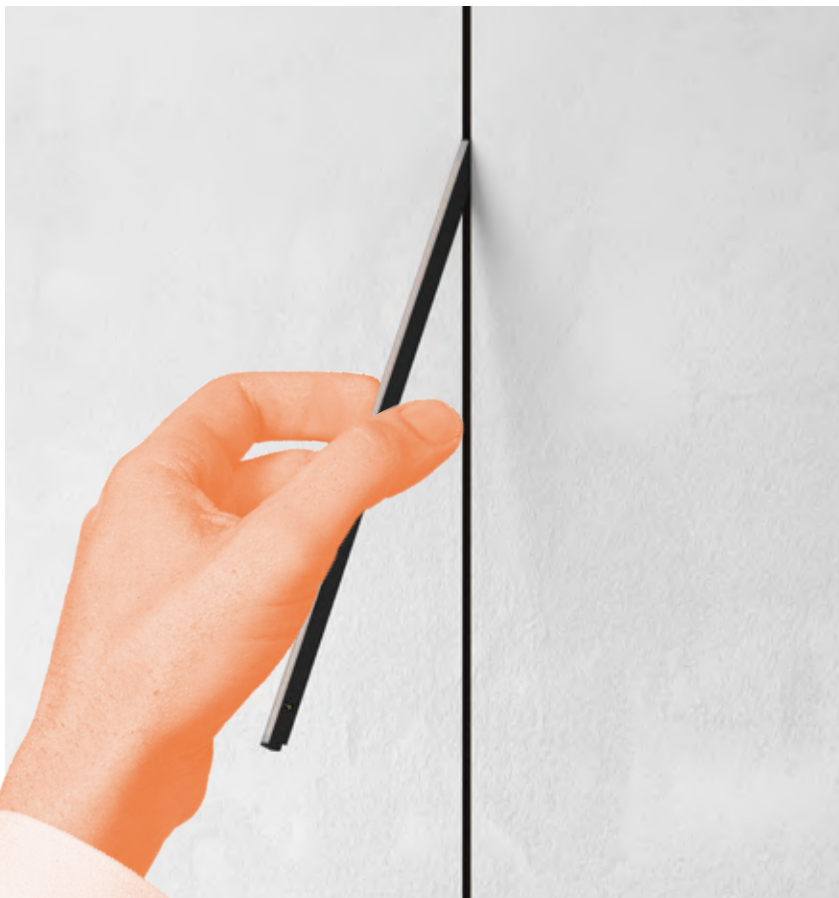







NANO SPOT

Con un diametro di soli 12mm questo incredibile proiettore garantisce valori di intensità elevati e permette di risolvere con grande semplicità i puntamenti più complessi rimanendo invisibile anche da distanze ravvicinate.

With a diameter of only 12 mm, this incredible projector guarantees high intensity values and allows you to easily resolve the most complex focal points while remaining invisible even from short distances.

SPOT MODULES

Gamma completa di microproiettori disponibili in varie potenze e dimensioni. Tutti includono microlenti professionali stabilizzate in acrilico per il massimo controllo degli effetti luminosi.

Complete range of micro-projectors available in various powers and sizes. They all include professional acrylic stabilized micro-lenses for a maximum control of lighting effects.

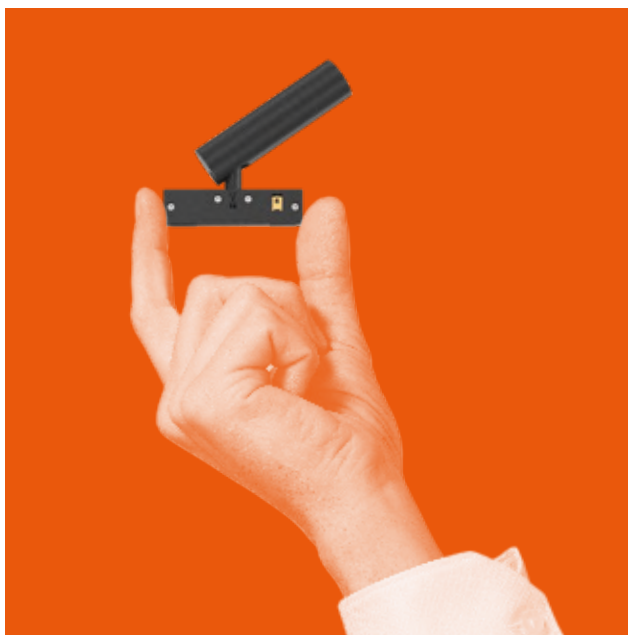

LIGHT SHADOW SPOT

Questo proiettore ultracompatto sfrutta il gruppo ottico di Light Shadow. Sorgente invisibile, cut-off integrato per un comfort visivo ed un'eleganza formale senza eguali.

This ultra-compact projector uses the same optical unit as Light Shadow. Invisible source, integrated cut-off for unparalleled visual comfort and formal elegance.

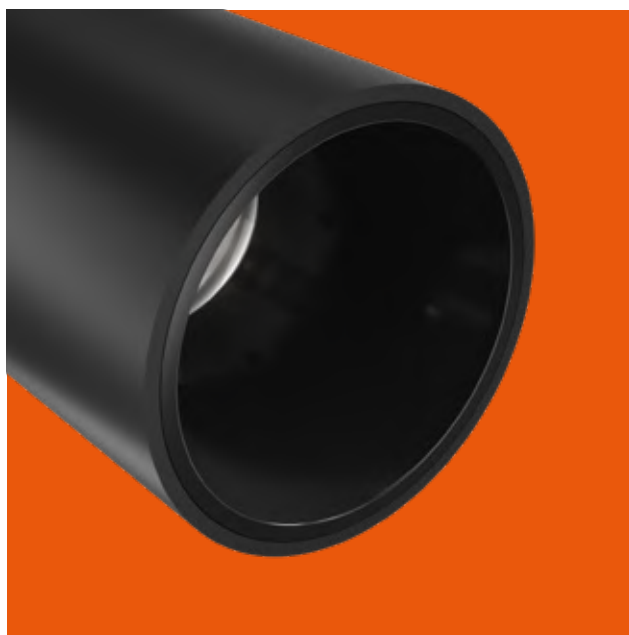

FIND ME

Proiettore per interni con sorgente luminosa LED, costituita da un corpo cilindrico che funge da downlight nella sua posizione superiore e diventa un faretto orientabile nella sua posizione inferiore.

Interior lighting projector with LED light source, consisting of a cylindrical body that acts as a downlight when set in its upper position and becomes an adjustable projector when set in its lower position.



LIGHT STRIPE DIFFUSED / WALL-WASHER

Microprofilo lineare con ottica miniaturizzata integrata diffusa o wall-washer. Quest'ultima sfrutta una speciale lente brevettata che emette un'illuminazione verticale estremamente uniforme e avvolgente. L'ideale per creare uno sfondo di luce morbido e privo di contrasti all'interno di una nicchia espositiva.

Linear micro-profile with an integrated miniature wall-washer optic. The special patented lens emits an extremely uniform and enveloping vertical lighting. It is ideal for creating a soft, non-contrasting light background within an exhibition niche.



CONNECTIONS (RECESSED)

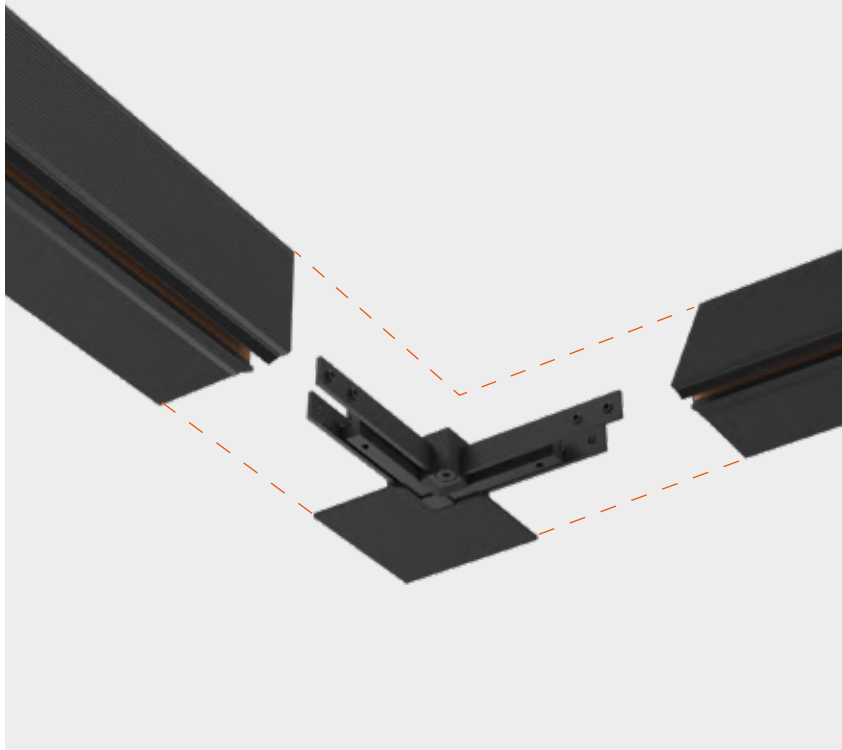

Il profilo ad incasso garantisce un risultato finale impeccabile grazie alle speciali ali di battuta laterali che consentono di rifinire l'installazione con dettagli di alta qualità.

The recessed profile guarantees a flawless final result thanks to the special blocking sides that allow the installation to be finished with high-quality details.

CONNECTIONS (SURFACE)



Installato a superficie, il profilo è talmente piccolo da scomparire alla vista, diventando una sottilissima linea di fuga che attraversa gli ambienti e consente di caratterizzarli con effetti luce sofisticati che invadono pareti, soffitti, corridoi e vetrine.

Installed on the surface, the profile is so small that it disappears from the eye, becoming a very thin line that crosses the rooms and characterizes them with sophisticated lighting effects that invade walls, ceilings, corridors and showcases.



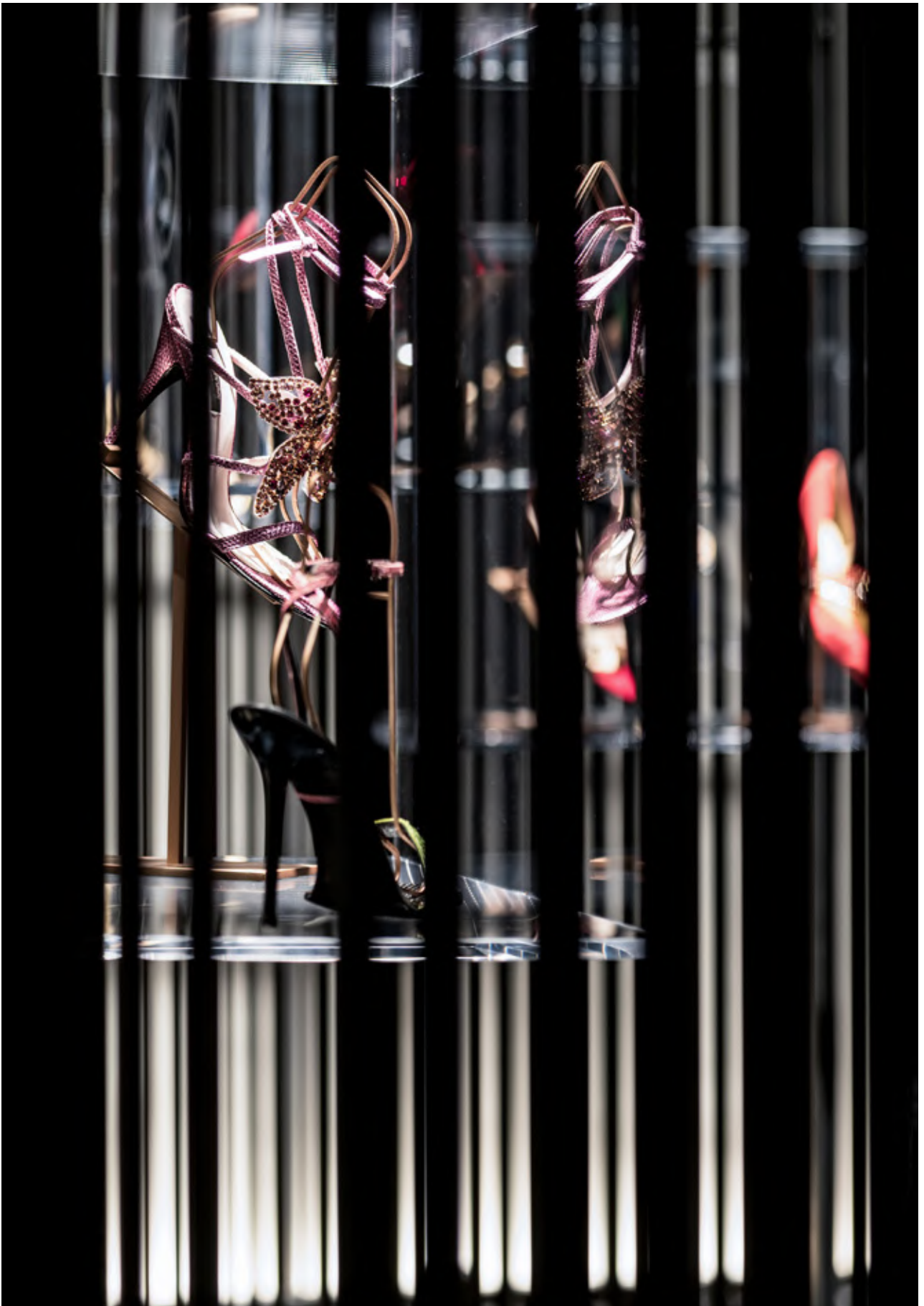

Sergio Rossi Showroom,
Milan



Sergio Rossi Showroom,
Milan

The Micro Running Magnet è la soluzione definitiva per l'illuminazione espositiva. Un programma completo e professionale che oltre alla dimensione ridottissima garantisce una luce bilanciata e attraente per risaltare ogni oggetto a 360° nel migliore dei modi.

The Micro Running Magnet is the ultimate solution for exhibition lighting. A complete and professional program that, in addition to its reduced dimensions, provides a balanced and attractive light to highlight each object in the best way and in 360°.

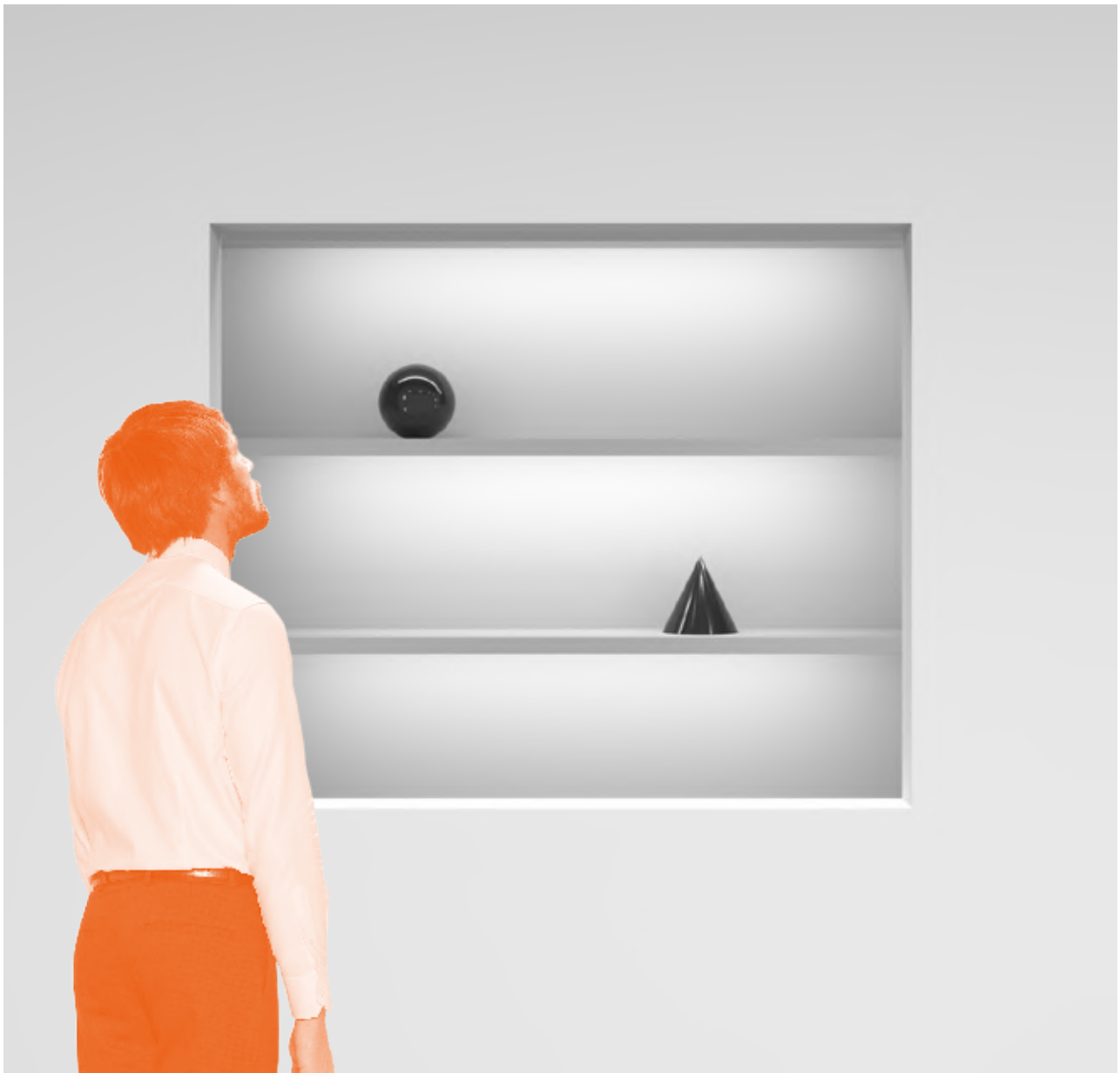

1 Micro proiettori LED con soluzioni cut-off integrate e lenti dedicate per creare contrasti e accenti di luce.

LED micro-projectors with integrated cut-off solutions and dedicated lenses to create contrasts and light accents.

2 Microprofilo lineare completo con schermo diffondente opalino per dettagli di luce diffusa.

Complete linear micro-profile with opal diffuser screen for diffused light details.

3 Microprofilo lineare wall-washer con lente brevettata per effetti di luce asimmetrica controllata.

Linear wall-washer micro-profile with patented lens for controlled asymmetric light effects.

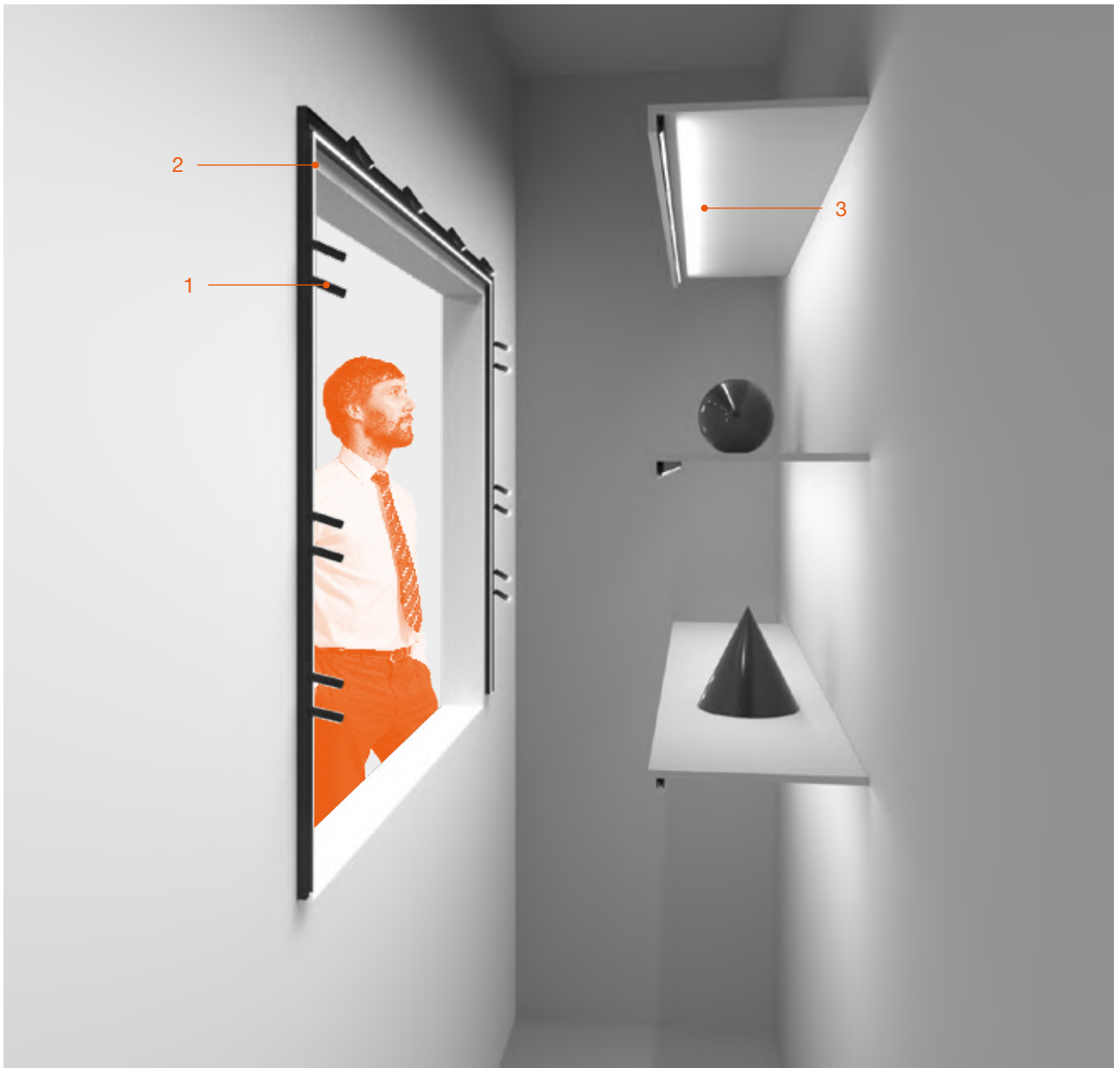



New Kvadrat Soft Cells
Showroom, London

	Diverse opzioni di controllo che possono adattarsi a qualunque necessità.	Different control options that can be adapted to any need.
DALI	Controllo broadcast di ciascun apparecchio di illuminazione.	Broadcast control of each luminaire.
1-10V	Controllo remoto in broadcasting (dimmeraggio di tutti gli apparecchi di illuminazione in gruppo).	Broadcasting remote control (dimming of all the luminaires in a single group).
CASAMBI	Controllo remoto in individuale e broadcast tramite applicazione dedicata FLOS Control®.	Individual & Broadcast control through a tablet or smartphone application (FLOS Control®).

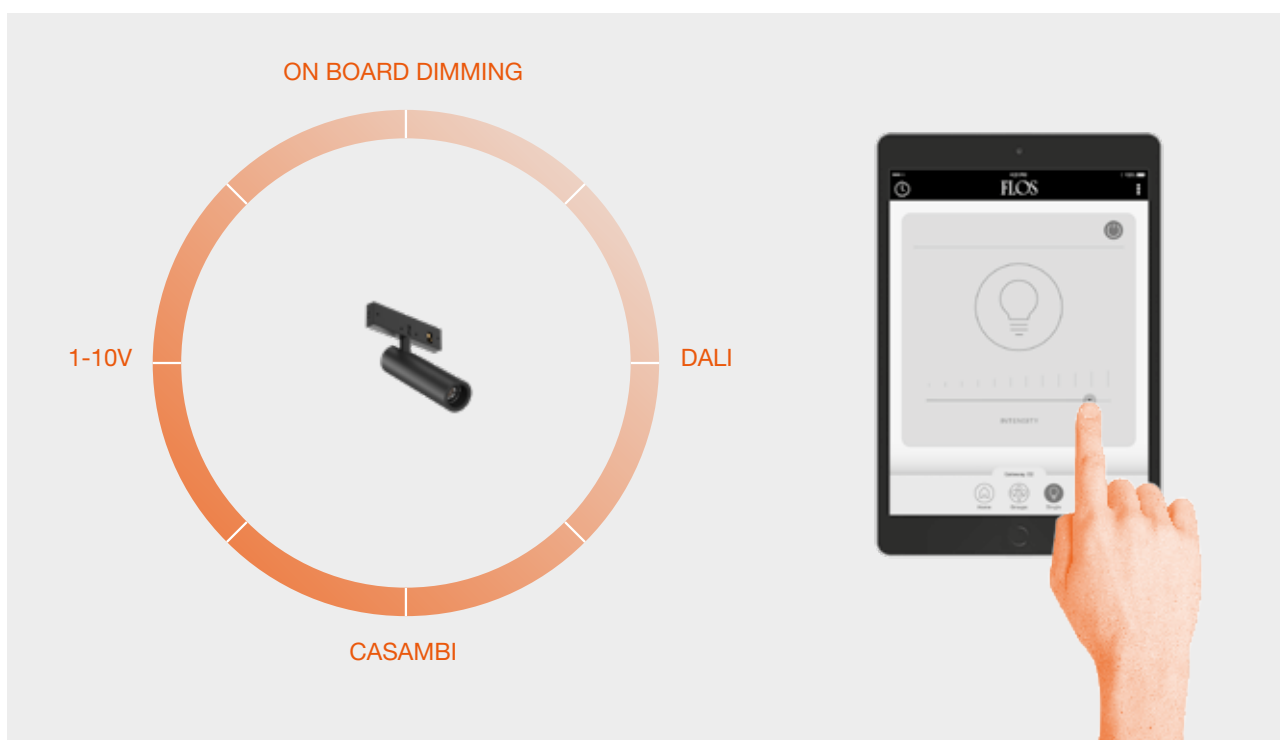

FLOS CONTROL® BY CASAMBI

L'applicazione FLOS Control® consente di gestire gli apparecchi di illuminazione del sistema controllando scene e programmazione.

In un impianto elettrico tradizionale, con il gateway connesso via Bluetooth si ottiene un controllo totale dell'ambiente.

Disponibile per iOS e Android

The FLOS Control® application allows you to control the system's luminaires controlling scenes and programming.

With a traditional electrical installation and the Gateway connected by Bluetooth, you obtain total control of the ambience.

Available for iOS and Android

FLOS
CONTROL BY CASAMBI





LIGHT MODULES

NANO SPOT

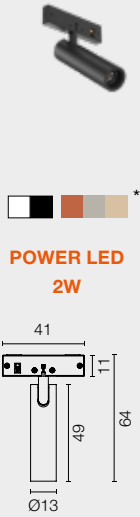

POWER LED
2W

MICRO SPOT



POWER LED
3W

SPOT



POWER LED
6W

LIGHT SHADOW
SPOT

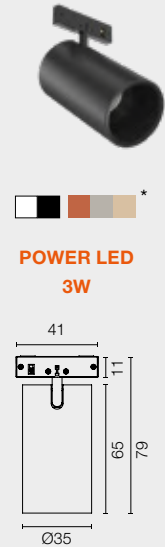

POWER LED
3W

FIND ME 0

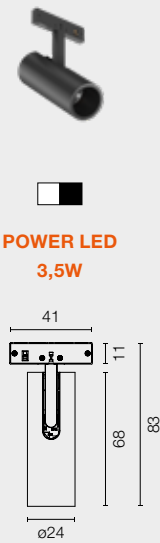

POWER LED
3,5W

FIND ME 1



POWER LED
5,5W

LIGHT STRIPE
DIFFUSED

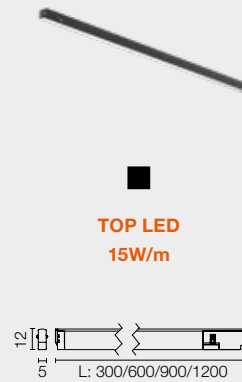

TOP LED
15W/m

LIGHT STRIPE
WALL-WASHER

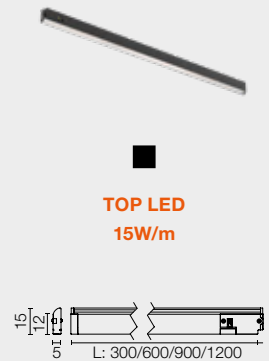

TOP LED
15W/m



Spot



Medium



Flood



Wall-Washer



Diffused

RECESSED



■ 14 Nero
14 Black

SURFACE



□ 40 Bianco
40 White ■ 14 Nero
14 Black

THE RUNNING

MAGNET

THE RUNNING

MAGNET

THE RUNNING

MAGNET

THE RUNNING

MAGNET

Programma di strutture in versione a incasso, in superficie e a sospensione. Vi si può alloggiare un'ampia gamma di apparecchi di illuminazione mediante fissaggio magnetico. Regolazione e controllo tramite protocolli universali e attraverso l'applicazione FLOS Control®.

Program of structures in recessed, surface and suspended versions. A wide range of light fixtures is housed inside it using magnetic fastening. Regulation and control with universal protocols and using the FLOS Control® application.

THE RUNNING MAGNET







La gamma è composta da speciali profili magnetici alimentati a 24V in cui si posizionano i moduli di illuminazione LED. I profili sono adatti per installazione a superficie, sospesa o ad incasso in pareti o soffitti in cartongesso. The Running Magnet si completa con moduli di illuminazione ambiente e d'accento con diverse ottiche, oltre a una selezione di apparecchi di illuminazione decorativi estratti e adattati dalla FLOS Home Collection.

The range consists of special 24V-powered magnetic profiles on which the LED lighting modules are placed. The profiles are suitable for surface, suspended or recessed installations in walls or plasterboard ceilings. The Running Magnet is completed by ambient and accent lighting modules with different optics, plus a selection of decorative lighting accessories originating and adapted from the FLOS Home Collection.

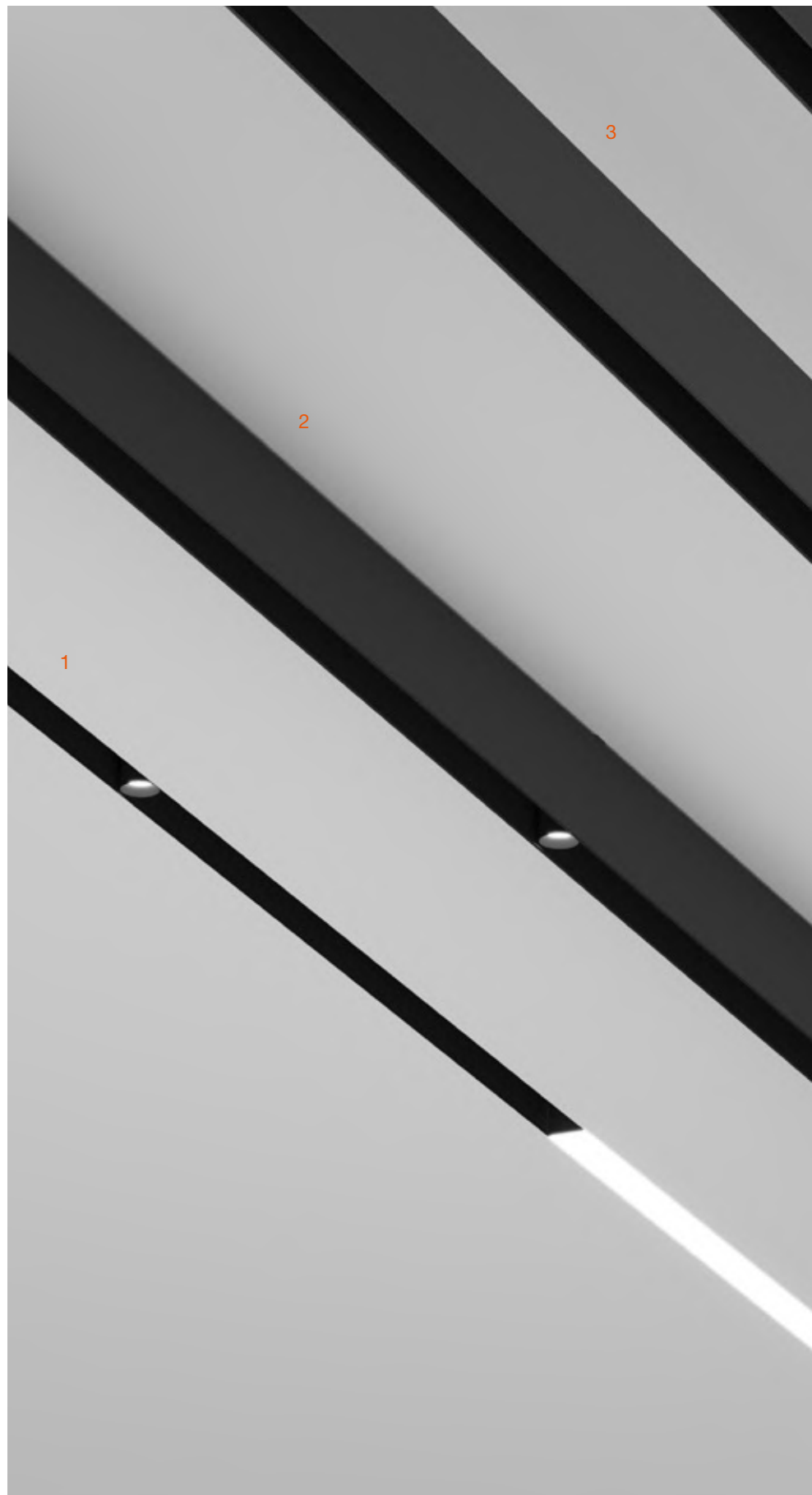

- 1 RECESSED
- 2 SURFACE
- 3 SUSPENSION DOWN
- 4 SUSPENSION UP&DOWN

4

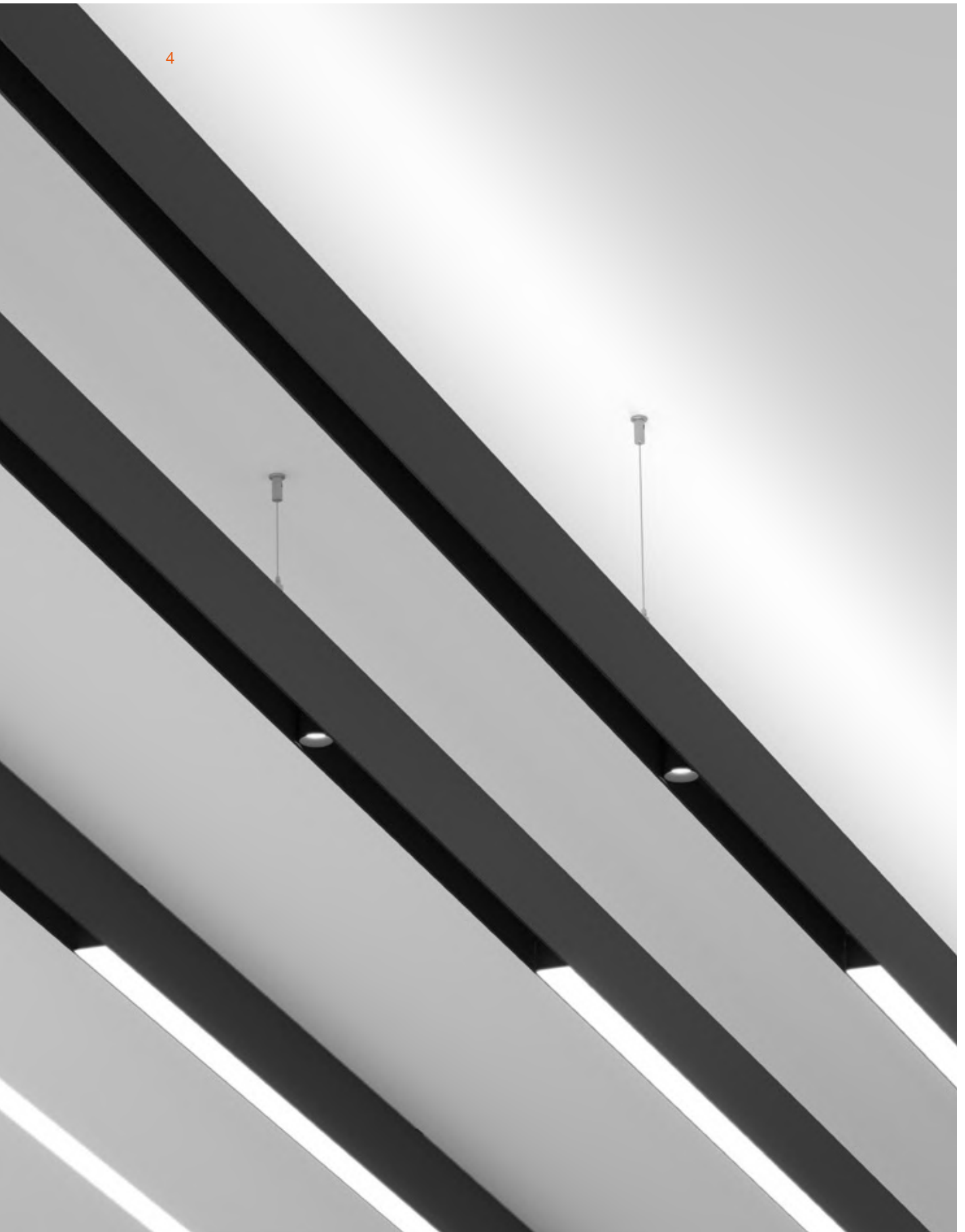





La soluzione per una fusione totale con l'architettura, ottenuta grazie all'integrazione totale degli apparecchi di illuminazione che possono scomparire all'interno delle superfici. La sua installazione magnetica consente di progettare la luce nello spazio con la massima semplicità. Compatibile con i principali sistemi di controllo e con FLOS Control®.

The solution for a total fusion with architecture, achieved thanks to the total integration of luminaires that can disappear inside surfaces. Its magnetic installation offers super easy way to design the light in space. Compatible with all main control systems and FLOS Control®.

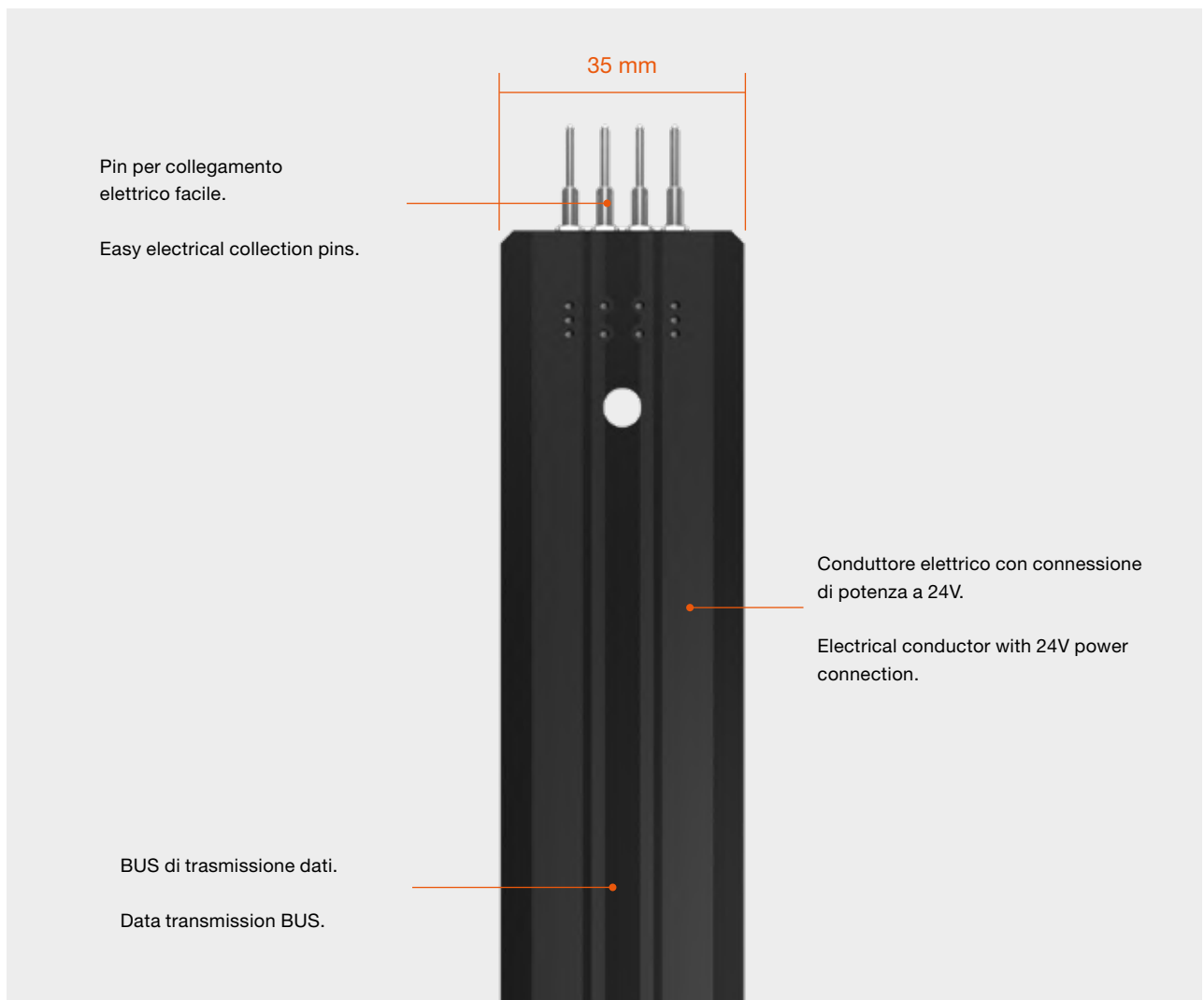



Boutek Offices, Italy







Fissaggio magnetico degli apparecchi di illuminazione, che consentono la manipolazione a caldo. Il corpi illuminanti si possono spostare da accese ottenendo enorme flexibilità e adattabilità della configurazione in qualunque momento.

Magnetic fixing of the luminaires, which allows hot handling. They can be moved while they are still on, achieving enormous flexibility and adaptability in the configuration at any time.





Cassina + Siematic
Showroom, Japan

SPOT MODULE

Modulo Spot con lente arretrata per un comfort visivo ottimale.

Spot module with far back positioned lens for optimal visual comfort.

1 Cilindro esterno schermante.
Exterior shield cylinder.

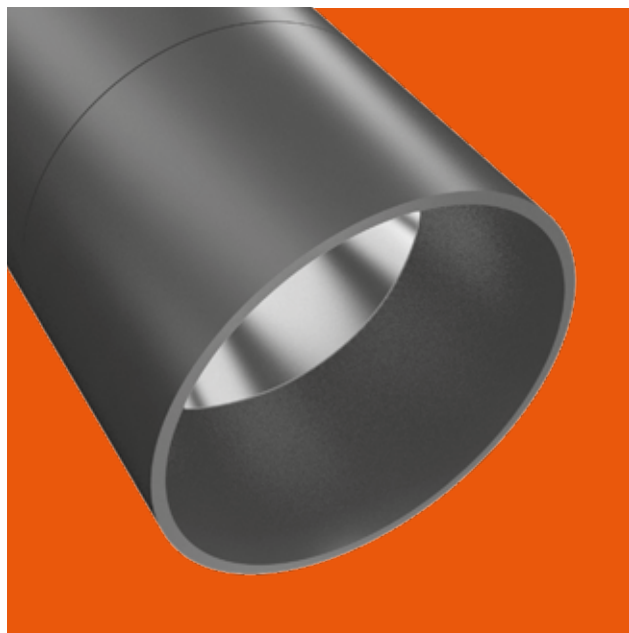

1

LIGHT SHADOW SPOT 30 / 45

Grazie alla soluzione ottica esclusiva brevettata, Light Shadow Spot controlla angoli di cut-off estremi, senza rinunciare all'alta efficienza e un'incredibile versatilità del prodotto.

Thanks to the unique patented optical solution, Light Shadow Spot controls extreme cut-off angles without altering the high efficiency and incredible versatility of the product.

2 Lente a doppio fuoco sviluppata da FLOS appositamente per questo prodotto. Garantisce massimo controllo ottico e un'eccezionale omogeneità del fascio luminoso.
Dual-focus lens developed by FLOS specifically for this product. It ensures maximum optical control and exceptional light beam homogeneity.

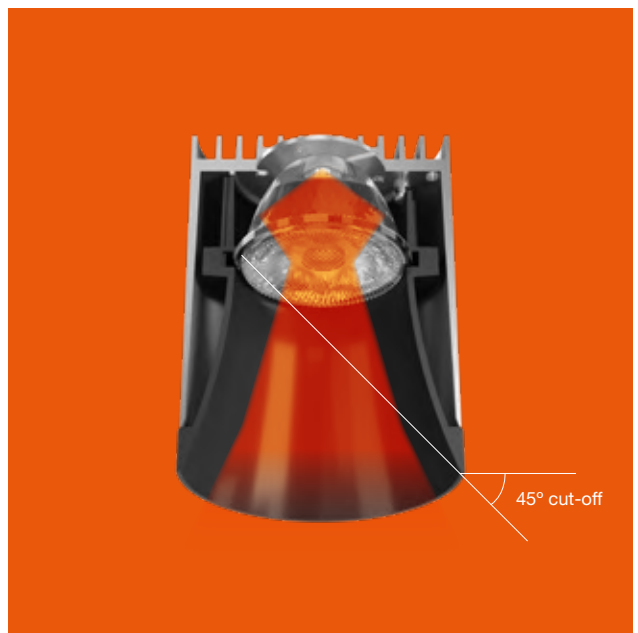

2

SPOT 120

Proiettore di potenza con design minimalista.
Massimo comfort visivo.

Power projector with minimal design.
Maximum visual comfort.

3 Accessori di schermatura disponibili in tutti i proiettori, per offrire sempre il massimo comfort visivo.
Shielding accessories available in all projectors, to always offer maximum visual comfort.

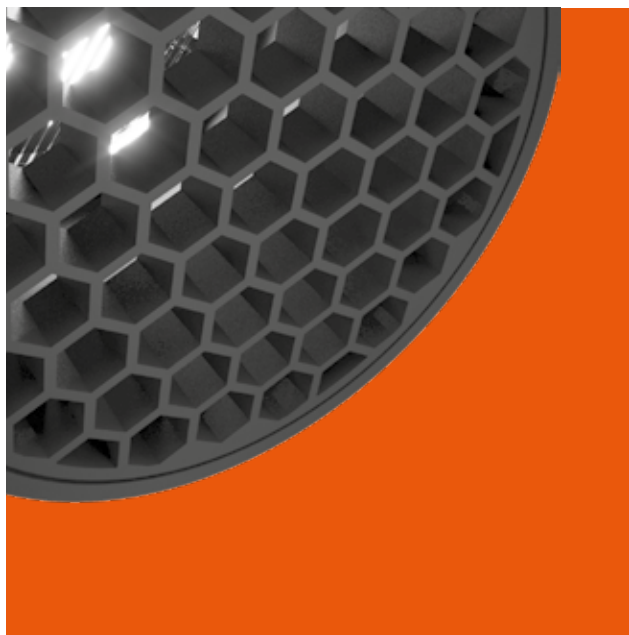
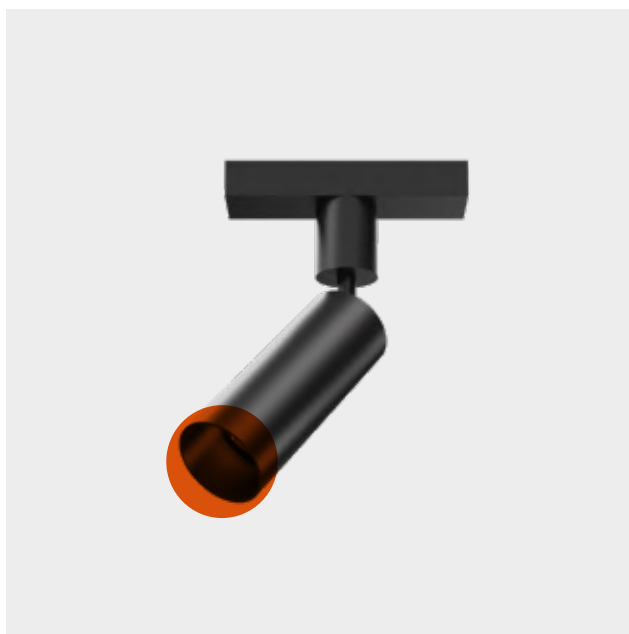

ANTHONY SPOT

Anthony Spot disegnato da Antonio Citterio: una forma con un pizzico di design d'avanguardia, semplice e allo stesso tempo elegante, che si distacca dai canoni tradizionali.

Anthony Spot designed by Antonio Citterio: a form with a touch of avant-garde design, simple yet elegant, which is distanced from traditional looks.

4 Innovativo design del dissipatore di calore.
Innovative heat skin design.

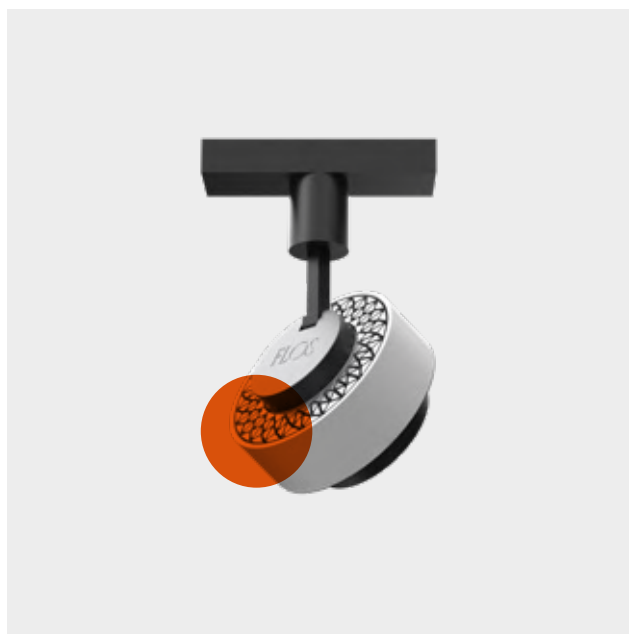





Parc 51, Belgium
Bottom

1410 Broadway,
New York
Top

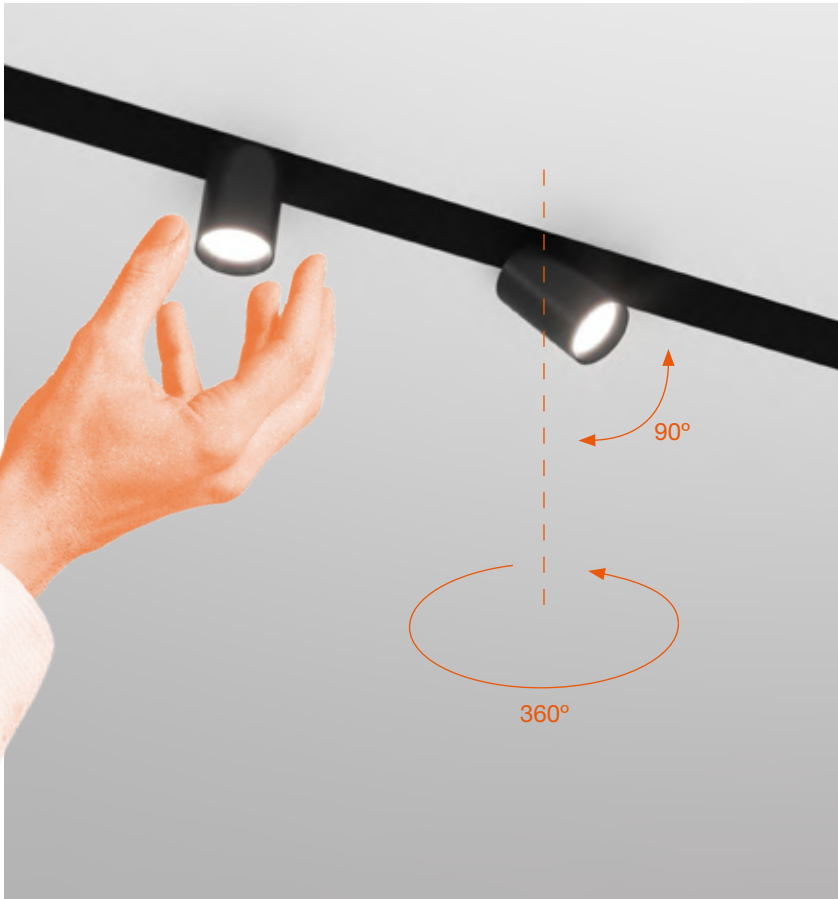

SPOT MODULE

Proiettore creato per la massima flessibilità e integrazione, dato che può essere collocato raso al profilo, come luce zenitale o estratto e orientato a 360 gradi, con un basculamento di 90 gradi.

Projector created for maximum flexibility and integration, as it can be fitted flat to the profile. Zenithally light or its extraction and orientation to 360 degrees and tilting to 90 degrees.



SPOT SUSPENSION

Modulo a sospensione estremamente compatto ed essenziale, ideale per effetti di luce d'accento puntuale ad alto contrasto.

Extremely compact and subtle suspension module, ideal for high-contrast lighting effects.







Barra luminosa magnetica disponibile in diverse lunghezze, con la possibilità di unirla ad altre eliminando l'effetto di interruzione della luce in corrispondenza della giuntura anche negli angoli. Il diffusore opale specificatamente sviluppato garantisce sia l'efficienza, sia l'omogeneità nell'integrazione architettonica.

Magnetic light bar available in different lengths, which offers the possibility of joining and eliminating the gap effect, even in corners. The specially developed opal diffuser guarantees both efficiency and homogeneity in architectural integration.



LIGHT STRIPE

303 mm



603 mm



903 mm



1203 mm







	Diverse opzioni di controllo che possono adattarsi a qualunque necessità.	Different control options that can be adapted to any need.
ON BOARD DIMMING	Ciascun apparecchio di illuminazione ha un dimmer integrato, per il controllo diretto e individuale.	Each luminaire has its own integrated dimmer for direct and individual control.
DALI	Controllo individuale di ciascun apparecchio di illuminazione.	Individual control of each luminaire.
1-10V	Controllo remoto in broadcasting (dimmeraggio di tutti gli apparecchi di illuminazione in gruppo).	Broadcasting remote control (dimming of all the luminaires in a single group).
CASAMBI	Controllo individuale di ciascun apparecchio di illuminazione direttamente attraverso un'applicazione per tablet e smartphone (FLOS Control®).	Individual control of each luminaire directly through a tablet or smartphone application (FLOS Control®).



FLOS CONTROL®
BY CASAMBI

L'applicazione FLOS Control® consente di controllare gli apparecchi di illuminazione del sistema in modo individuale o in gruppo, controllando scene e programmazione.

In un impianto elettrico tradizionale, con il gateway connesso via Bluetooth si ottiene un controllo totale dell'ambiente.

Disponibile per iOS e Android

The FLOS Control® application allows you to control the system's luminaires individually or as a group, controlling scenes and programming.

With a traditional electrical installation and the Gateway connected by Bluetooth, you obtain total control of the ambience.

Available for iOS and Android

LIGHT MODULES

LIGHT STRIPE



TOP LED
25W/m

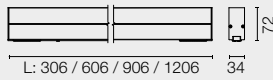

SPOT MODULE



POWER LED
8W

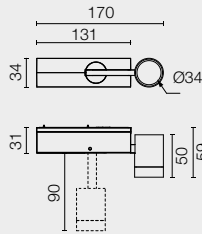

SPOT 120



POWER LED
12,5W/14W DALI

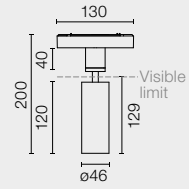

LIGHT SHADOW SPOT 30



POWER LED
4W

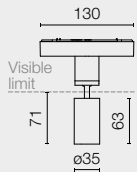

LIGHT SHADOW SPOT 45



LED ARRAY
10W

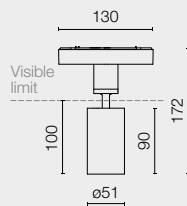

ANTHONY SPOT TRACK



POWER LED
14W

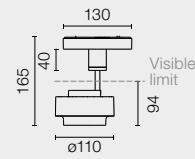

LIGHT MODULES

WORKMATES SMALL



TOP LED
Up to 10,5W

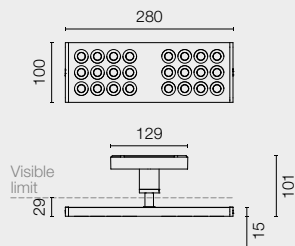

WORKMATES LARGE



TOP LED
Up to 13,5W

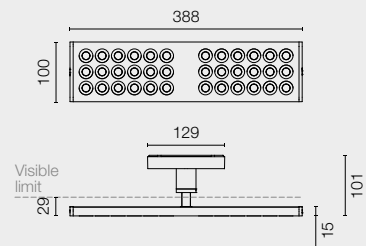

MULTI SPOT 4



POWER LED
10W

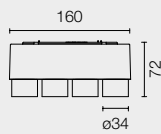

LIGHT SHADOW



POWER LED
10,8W

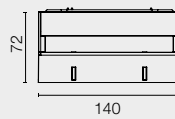

LIGHT SHADOW
WALL-WASHER



POWER LED
10,8W

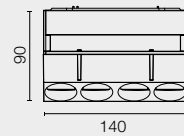

LIGHT MODULES

STRING LIGHT



POWER LED
14W

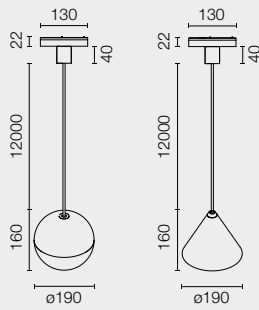

MINI GLO-BALL



POWER LED
3,5/7W

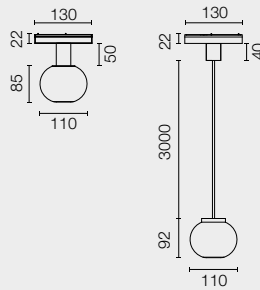

FIND ME
SUSPENSION



POWER LED
8W

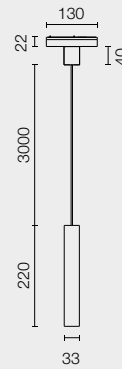

Spot



Medium



Flood



Wide Flood



Oval



Wall-Washer



Diffused

PROFILES

RECESSED



■ 14 Nero
14 Black

SURFACE



□ 40 Bianco
40 White

SUSPENSION
UP&DOWN / DOWN

■ 14 Nero
14 Black

MULTIFUNCTION
SMART DEVICE

FLOS CONTROL®
by Casambi

FLOS
CONTROL BY CASAMBI



THE TRACKING

MAGNET

WAGNET

MAGNET

WAGNET

MAGNET

WAGNET

Profilo compatto e compatibile con apparecchi di illuminazione a fissaggio magnetico. Il programma dispone di versioni a incasso, in superficie e a sospensione. Regolazione e controllo tramite protocolli universali e attraverso l'applicazione FLOS Control®.

Compact profile, compatible with magnetic fastening light fixtures. The program has recessed, surface and suspended versions. Regulation and control with universal protocols and using the FLOS Control® application.

THE TRACKING MAGNET

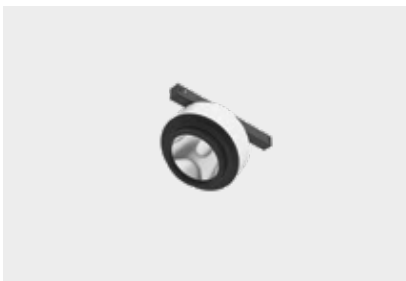
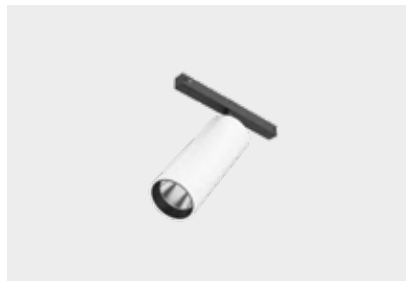





Il sistema è composto da profili magnetici alimentati a 48V in cui si posizionano i moduli di illuminazione LED. I profili sono adatti per installazione a superficie, sospesa o ad incasso in pareti o soffitti in cartongesso. The Tracking Magnet si completa con moduli di illuminazione ambiente e d'accento con diverse ottiche, oltre ad uno speciale modulo per illuminazione puntuale a parete.

The system consists of magnetic profiles powered at 48V where the LED lighting modules are placed. The profiles are suitable for surface, suspended or recessed installations in walls or plasterboard ceilings. The Tracking Magnet is completed by ambient and accent lighting modules with different optics, as well as by a special module for spot lighting on walls.



- 1 RECESSED
- 2 SURFACE
- 3 SUSPENSION DOWN
- 4 SUSPENSION UP&DOWN

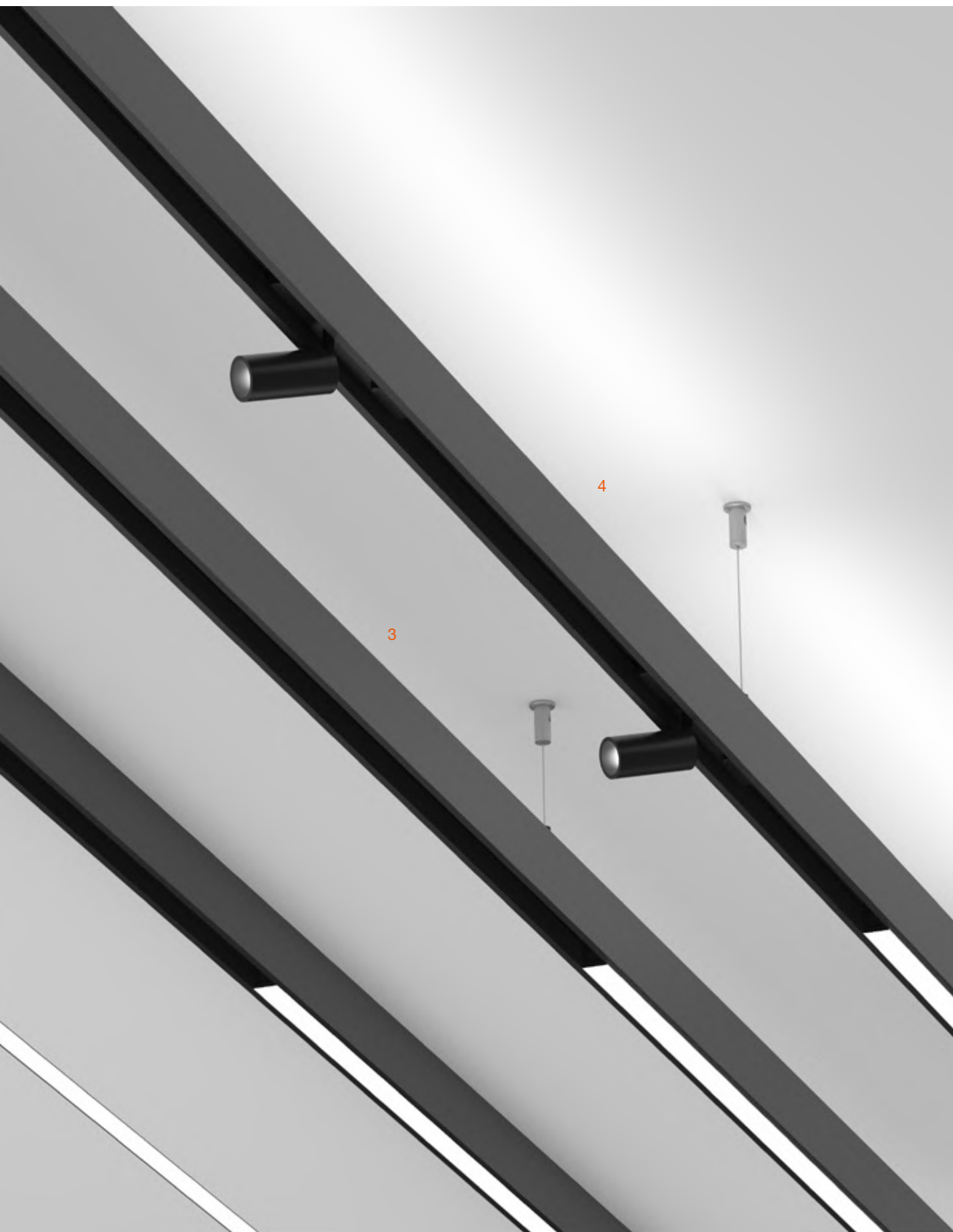









Una linea minima di soli 15 mm di larghezza, ottenuta grazie all'estrema miniaturizzazione dei corpi elettronici ed ottici. The Tracking Magnet offre una collezione completa di soluzioni di illuminazione per soddisfare tutte le necessità. È compatibile con i principali sistemi di controllo e con FLOS Control®. La sua installazione magnetica ne consente la configurazione nello spazio in totale libertà.

A minimal line only 15 mm wide, achieved through the extreme miniaturization of the electronics and the optical bodies. The Tracking Magnet offers a complete collection of lighting tools for any need, compatible with all main control systems and FLOS Control®. Its magnetic installation gives total freedom to be configured in space.









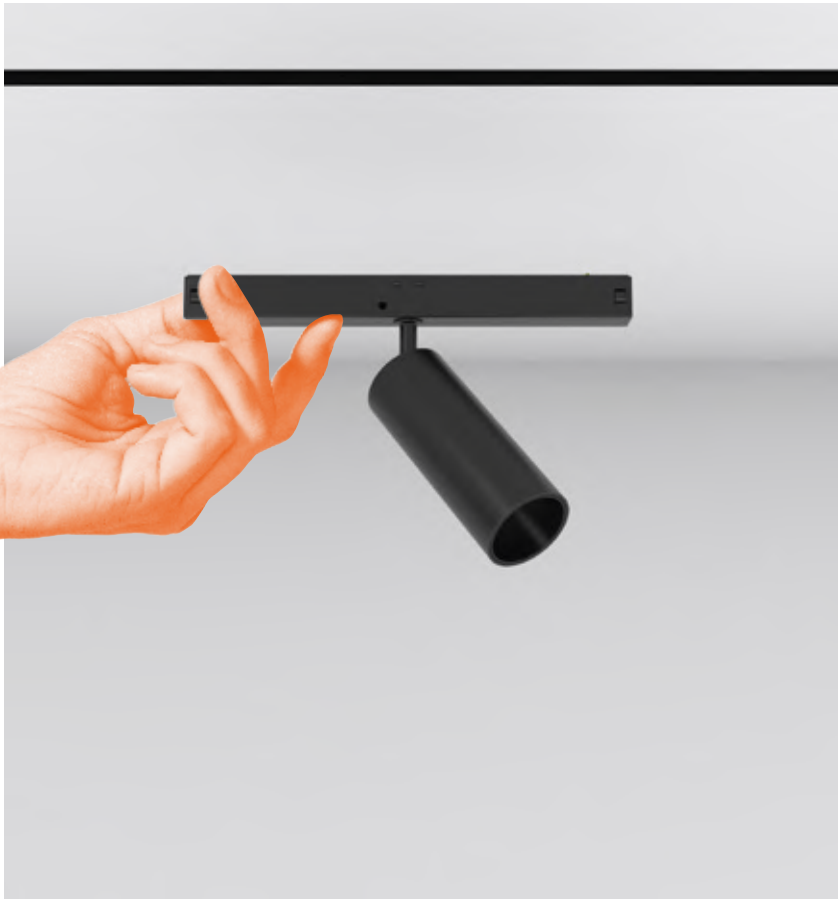

Fissaggio magnetico degli apparecchi di illuminazione, che consentono la manipolazione a caldo, si possono spostare con il binario in tensione ottenendo una enorme flessibilità e adattabilità della configurazione in qualunque momento.

Magnetic fixing of the luminaires, which allows hot handling. They can be moved while the track is connected, achieving enormous flexibility and adaptability in the configuration at any time.





Bulb Millenium Offices,
Czech Republic

Barra luminosa magnetica disponibile in diverse lunghezze, con la possibilità di unirla ad altre eliminando l'effetto di interruzione della luce in corrispondenza della giuntura anche negli angoli. Il diffusore opale specificamente sviluppato garantisce sia l'efficienza, sia l'omogeneità nell'integrazione architettonica.

Magnetic light bar available in different lengths, which offers the possibility of joining and eliminating the gap effect, even in corners. The specially developed opal diffuser guarantees both efficiency and homogeneity in architectural integration.



303 mm



603 mm



903 mm



1203 mm



1503 mm





Carbonado Energy, South Africa

LIGHT SHADOW SPOT 30 / 45

Grazie alla soluzione ottica esclusiva brevettata, Light Shadow Spot controlla angoli di cut-off estremi, senza rinunciare all'alta efficienza e un'incredibile versatilità del prodotto.

Thanks to the unique patented optical solution, Light Shadow Spot controls extreme cut-off angles without altering the high efficiency and incredible versatility of the product.

1 Lente a doppio fuoco sviluppata da FLOS appositamente per questo prodotto. Garantisce massimo controllo ottico e un'eccezionale omogeneità del fascio luminoso.
Dual-focus lens developed by FLOS specifically for this product. It ensures maximum optical control and exceptional light beam homogeneity.

SPOT TRACKING 50 / 90 / 120 / 150

Famiglia di proiettori di diverse potenze e ottiche per qualunque necessità.

Family of spots with different powers and optics for any need.

2 Disponibili versioni di spot 120 e 150 con ottica a riflettori, per offrire fasci di luce più aperti e più potenza.
Spot versions 120 and 150 with reflector optics available, to offer wider and more powerful light beams.

LIGHT SHADOW SPOT 30

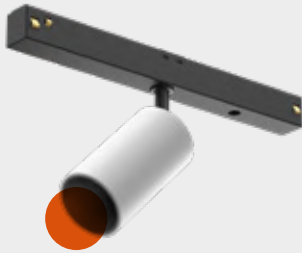

SPOT 150

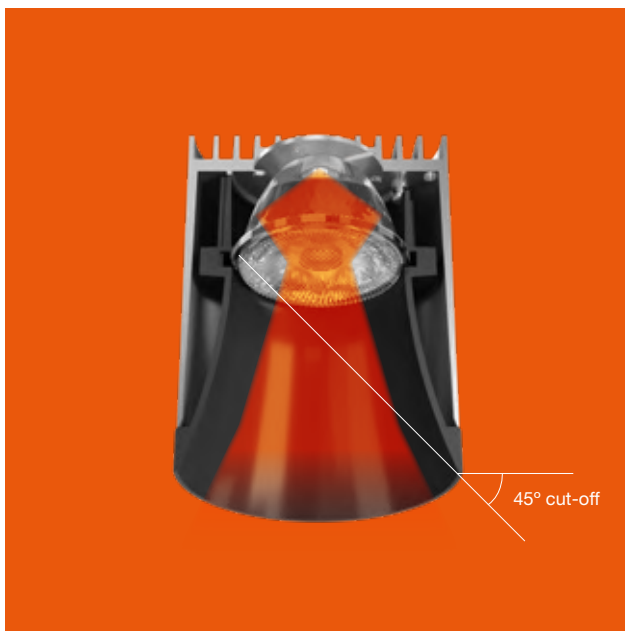

1



2

WALLEE

Apparecchio di illuminazione disegnato da Niels Bendtsen per l'illuminazione di quadri e pareti, grazie alla sua distribuzione omogenea ed elegante della luce di alta qualità.

Luminaire designed especially by Niels Bendtsen for lighting frames and walls, thanks to its homogenous and elegant distribution of high-quality light.

3 Testina orientabile di 50 gradi per la perfetta regolazione della luce.
Head adjustable to 50 degrees for the perfect light setting.

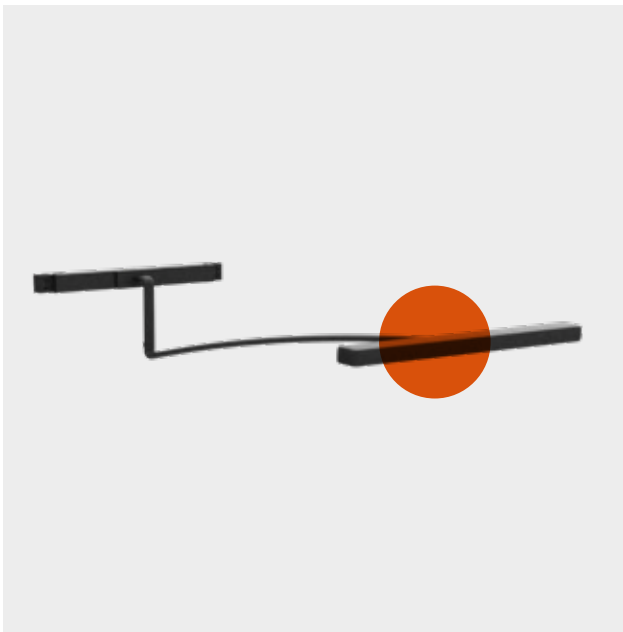

3

ANTHONY SPOT

Anthony Spot disegnato da Antonio Citterio: una forma con un tocco di design, semplice e al contempo elegante, che si distacca dai canoni tradizionali.

Anthony Spot designed by Antonio Citterio: a form with a touch of avant-garde design, simple yet elegant, which is distanced from the traditional looks.

4 Innovativo design del dissipatore di calore.
Innovative heat skin design.

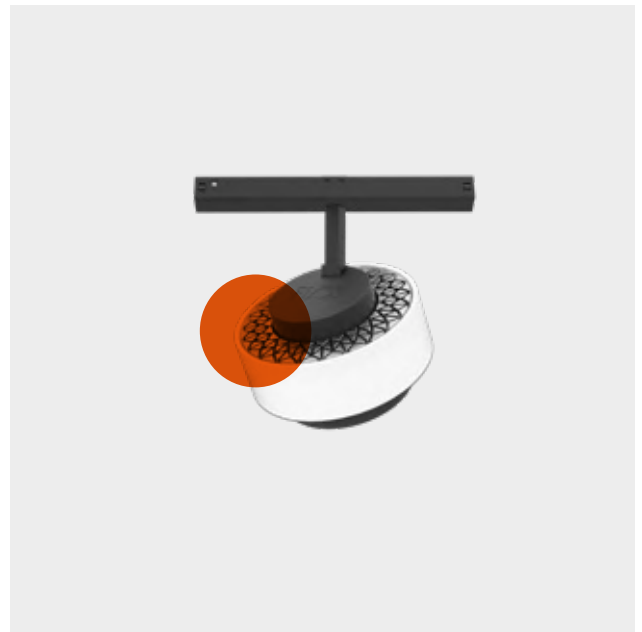

4



Sergio Rossi, London

	Diverse opzioni di controllo che possono adattarsi a qualunque necessità.	Different control options that can be adapted to any need.
ON BOARD DIMMING	Ciascun apparecchio di illuminazione ha un dimmer integrato, per il controllo diretto e individuale.	Each luminaire has its own integrated dimmer for direct and individual control.
DALI	Controllo individuale di ciascun apparecchio di illuminazione.	Individual control of each luminaire.
1-10V	Controllo remoto in broadcasting (dimmeraggio di tutti gli apparecchi di illuminazione in gruppo).	Broadcasting remote control (dimming of all the luminaires in a single group).
CASAMBI	Controllo individuale di ciascun apparecchio di illuminazione direttamente attraverso un'applicazione per tablet e smartphone (FLOS Control®).	Individual control of each luminaire directly through a tablet or smartphone application (FLOS Control®).



FLOS CONTROL®
BY CASAMBI

L'applicazione FLOS Control® consente di controllare gli apparecchi di illuminazione del sistema in modo individuale o in gruppo, controllando scene e programmazione.

In un impianto elettrico tradizionale, con il gateway connesso via Bluetooth si ottiene un controllo totale dell'ambiente.

Disponibile per iOS e Android

The FLOS Control® application allows you to control the system's luminaires individually or as a group, controlling scenes and programming.

With a traditional electrical installation and the Gateway connected by Bluetooth, you obtain total control of the ambience.

Available for iOS and Android





LIGHT MODULES

LIGHT STRIPE



TOP LED
20W/M

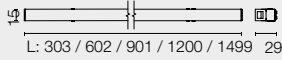

SPOT 50



POWER LED
3,5W

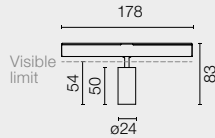

SPOT 90



POWER LED
8,5W

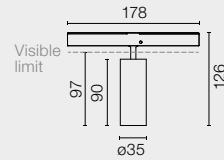

SPOT 120



POWER LED
12W

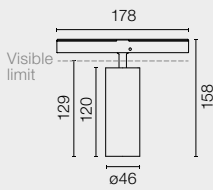

SPOT 120



LED ARRAY
12,5W

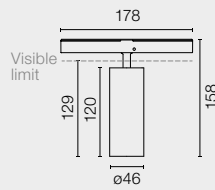

SPOT 150



LED ARRAY
22,5W

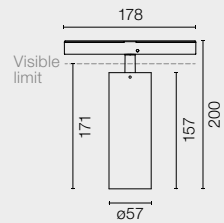

LIGHT SHADOW SPOT 30



POWER LED
4,5W

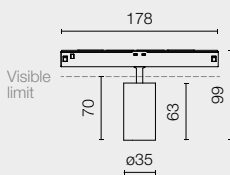

LIGHT SHADOW SPOT 45



LED ARRAY
10W

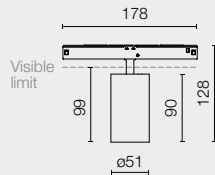

LIGHT SHADOW SPOT 60



LED ARRAY
Up to 20W

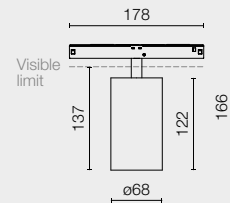

Super Spot



Spot



Medium



Flood



Wide Flood

LIGHT MODULES

WALLEE

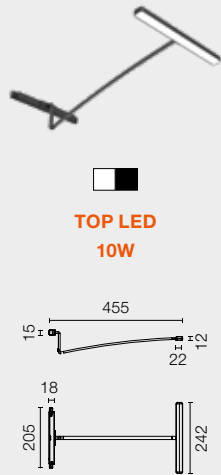

ANTHONY SPOT TRACK

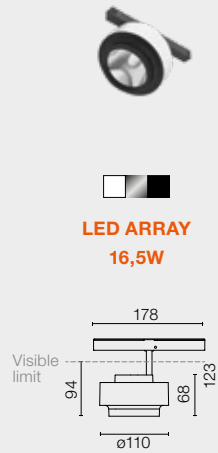

RECESSED



■ 14 Nero
14 Black

SURFACE



□ 40 Bianco
40 White

SUSPENSION
UP&DOWN / DOWN



■ 05 Alluminio Lucido
05 Polished Aluminium

■ 14 Nero
14 Black

MULTIFUNCTION
SMART DEVICE



FLOS CONTROL®
by Casambi

Binario trifase di dimensioni ridotte nella sua versione a incasso. Compatibile con un programma di apparecchi di illuminazione compatti e potenti.

3-phase rail with reduced dimensions in its recessed version. Compatible with a compact and powerful light fixture program.

THE TRACKING POWER EVO

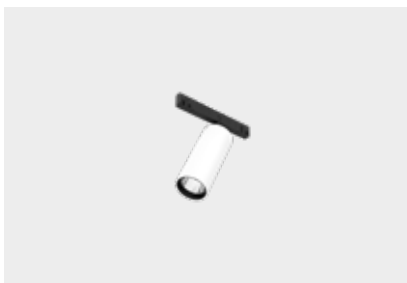



Issey Miyake Store,
Germany



Tracking Power è provvisto di piste elettriche sulle quali si installano gli apparecchi attraverso un sistema esclusivo di fissaggio Flos.

The Tracking Power is equipped with electric tracks on which the luminaries are installed through an exclusive Flos fixing system.





Versace Boutique, Miami

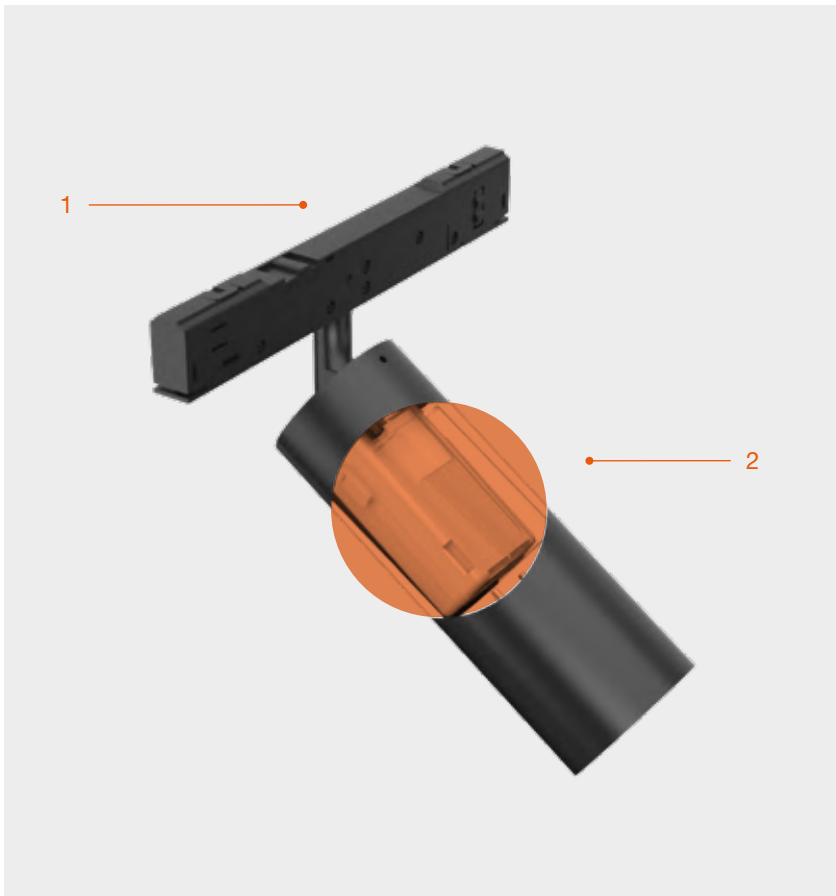

Il binario trifase secondo Flos. Grazie al suo sistema di ancoraggio miniaturizzato può ospitare, in uno spazio ridotto, una completa gamma di soluzioni di illuminazione ad alta potenza per usi professionali.

The three-phase rail according to Flos. Thanks to its miniaturized anchorage system it is capable to host in a small space a complete range of high power lighting tools for professional applications.

UT SPOT MODULES

1 Rivoluzionario design del track che consente un'integrazione totale. Revolutionary track design that allows a total integration.

2 Elettronica di controllo totalmente integrata nella testa del proiettore. Control electronics totally integrated into the projector head.

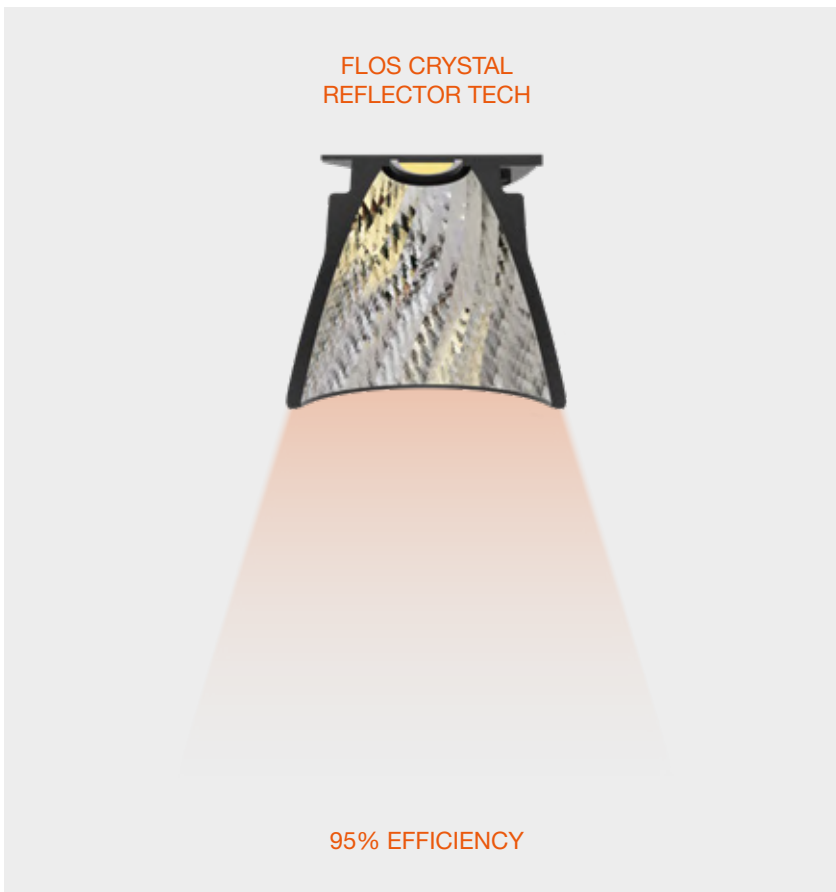

Rivoluzionario riflettore in vetro di borosilicato, che offre una efficienza luminosa fino al 95%. Grazie alla sua sfaccettatura, garantisce un controllo totale del fascio di luce.

Revolutionary reflector in borosilicate glass that offers light efficiency of up to 95%. Thanks to its faceting, it guarantees total control of the light beam.







SPOT 150 / SPOT 175

Proiettori dal design minimalista che si integrano in tutte le estetiche e con diverse opzioni di angolo e potenza.

Projectors with minimal design which can be integrated into all aesthetics and with different angle and power options.

1 Potenziometro a bordo per il controllo dell'intensità individuale di ciascun apparecchio di illuminazione.
On-board Dimming for individual intensity control for each luminaire.

2 Accessori di schermatura per tutti i proiettori.
Shielding accessories available for all projectors.



1



2

WALL WASHER

Nuovo wall-washer che grazie al suo riflettore disegnato da FLOS offre una dimensione extra compatta unitamente a livelli di omogeneità luminosa impeccabili.

New wall-washer which, thanks to its reflector designed by FLOS, offers an extra compact size together with impeccable levels of light homogeneity.

3 Fonte luminosa con retroproiezione per il massimo comfort visivo e omogeneità.
Back projection light source for maximum visual comfort and homogeneity.



WORKMATES SMALL / LARGE

Workmates è dotata di sorgenti luminose LED *High Efficiency* e *Full Spectrum*. Con la prima si ottiene un rendimento eccellente in termini di Lm/W, mentre con l'opzione *Full Spectrum* si raggiunge un indice NLAS (*Natural Light Average Secondment*) perfetto.

Workmates is fitted with *High Efficiency* and *Full Spectrum* LED light sources. With the former, you get excellent performance in terms of lm/W, while with the *Full Spectrum* option, you get the perfect NLAS (*Natural Light Average Secondment*) index.





Kvadrat Showroom,
Copenhagen



Bombas Gens, Spain

RECESSED



■ 14 Nero
■ 14 Black

LIGHT MODULES

UT PRO 150



LED ARRAY
21W

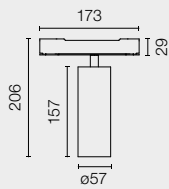

UT PRO 175



LED ARRAY
35,3W

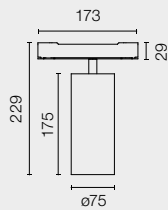

UT PRO WALL-WASHER



TOP LED
25,5W

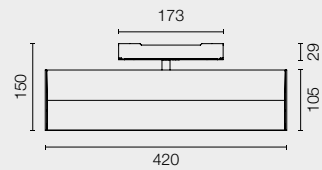

Super Spot



Spot



Medium



Flood



Wide Flood



Oval

LIGHT MODULES

WORKMATES IN-TRACK
SMALL



POWER LED
Up to 15,5W

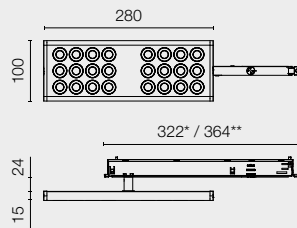

Non Dimming* / Dali**

WORKMATES IN-TRACK
LARGE



POWER LED
Up to 22W

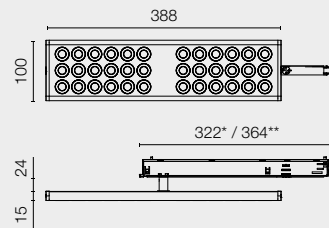

Non Dimming* / Dali**

CAMERA Ø60



LED ARRAY
UP to 20W

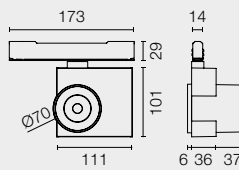

CAMERA Ø90



LED ARRAY
UP to 32W

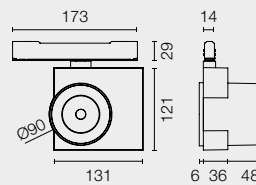

**THE
THE
THE
THE**

**FAST
FAST
FAST
FAST**

**TRACK
TRACK
TRACK
TRACK**

Sistema in grado di spostare e orientare proiettori motorizzati lungo una struttura. Versioni ad alta efficienza con ottiche da superspot a flood. Facile manipolazione grazie all'esclusivo FLOS Control®.

A system capable of moving and guide motorised projectors along a structure. High efficiency versions with optics from superspot to flood. Easy handling through the exclusive FLOS Control®.

THE FAST TRACK







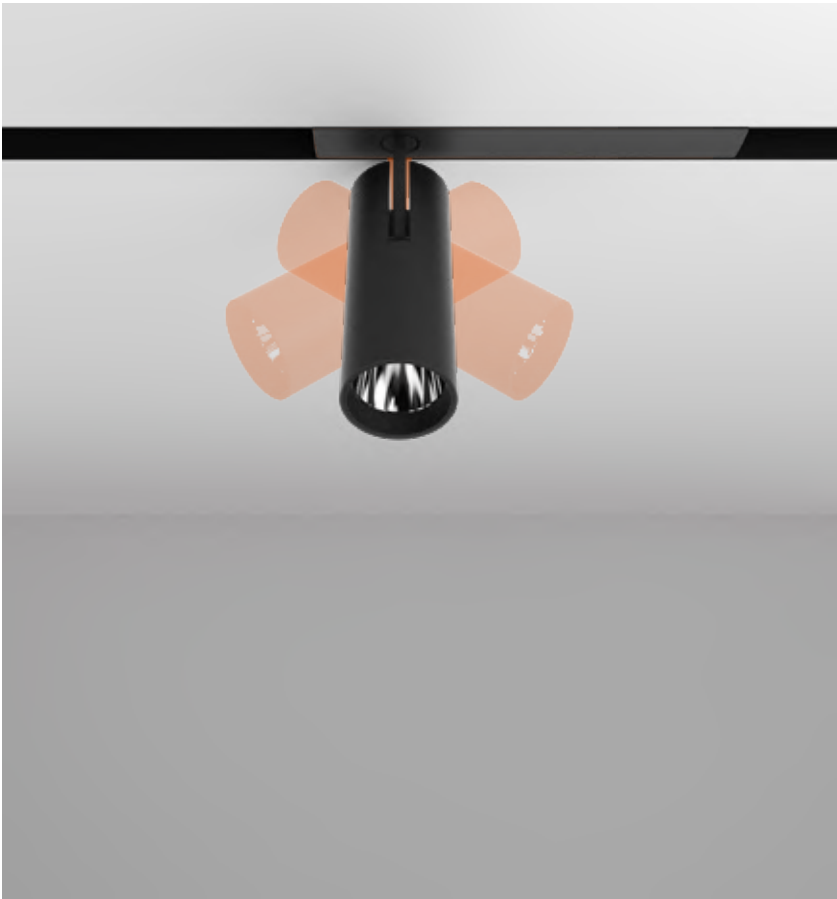

Prodotto rivoluzionario che consente di gestire il movimento sui tre assi: rotazione, inclinazione e traslazione.

Revolutionary product that allows movement management in the three axes: rotation, tilting and translation.



Facile controllo della luce dall'applicazione FLOS Control® disponibile per iOS e Android. Semplice connessione via bluetooth.

Easy light control from the FLOS Control® application available for IOS and Android. Friendly interface with bluetooth connection.





Flos arriva dove nessuno era mai arrivato. Esclusivo movimento di traslazione e orientamento di un sistema di proiettori che può essere programmato e controllato a distanza con FLOS Control®. Tecnologia estrema e semplicità di servizio.

Flos moves to an unprecedented level. Exclusive translation and orientation movement of a projectors system capable of being programmed and controlled remotely with FLOS Control®. Extreme technology & simplicity of service.

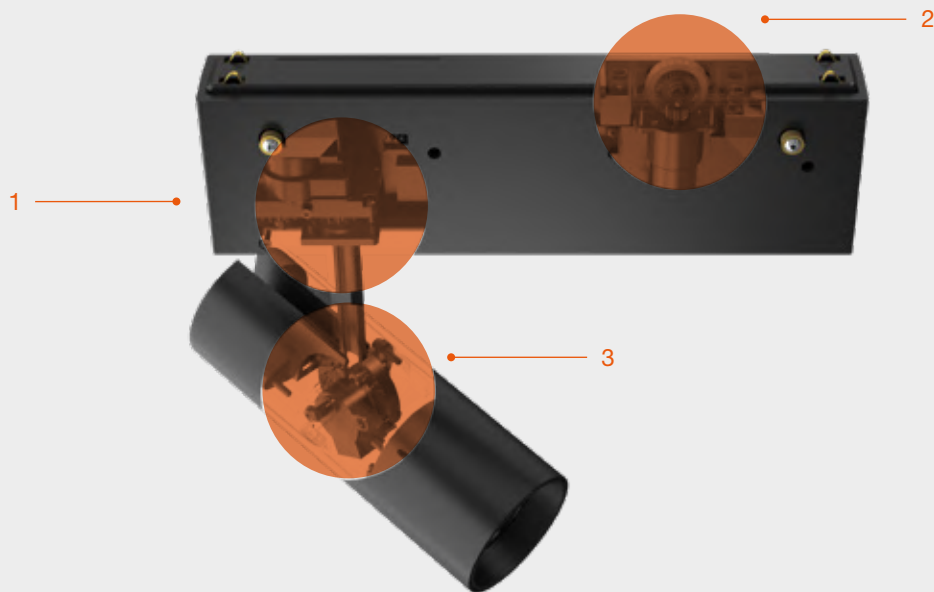

1 Motore rotazione. Sensore ottico che rileva in qualunque momento la posizione dello spot sul profilo. Rotation motor. Optical sensor that detects the spot position in the profile at any time.

2 Motore traslazione. Cuscinetto in gomma dotato di un ammortizzatore che garantisce il contatto costante con il profilo per una traslazione impeccabile. Translation motor. Rubber bearing equipped with a shock absorber that ensures constant contact with the profile for an excellent translation.

3 Motore basculazione. Sensore di fine corsa. Tilt motor. Limit switch sensor.

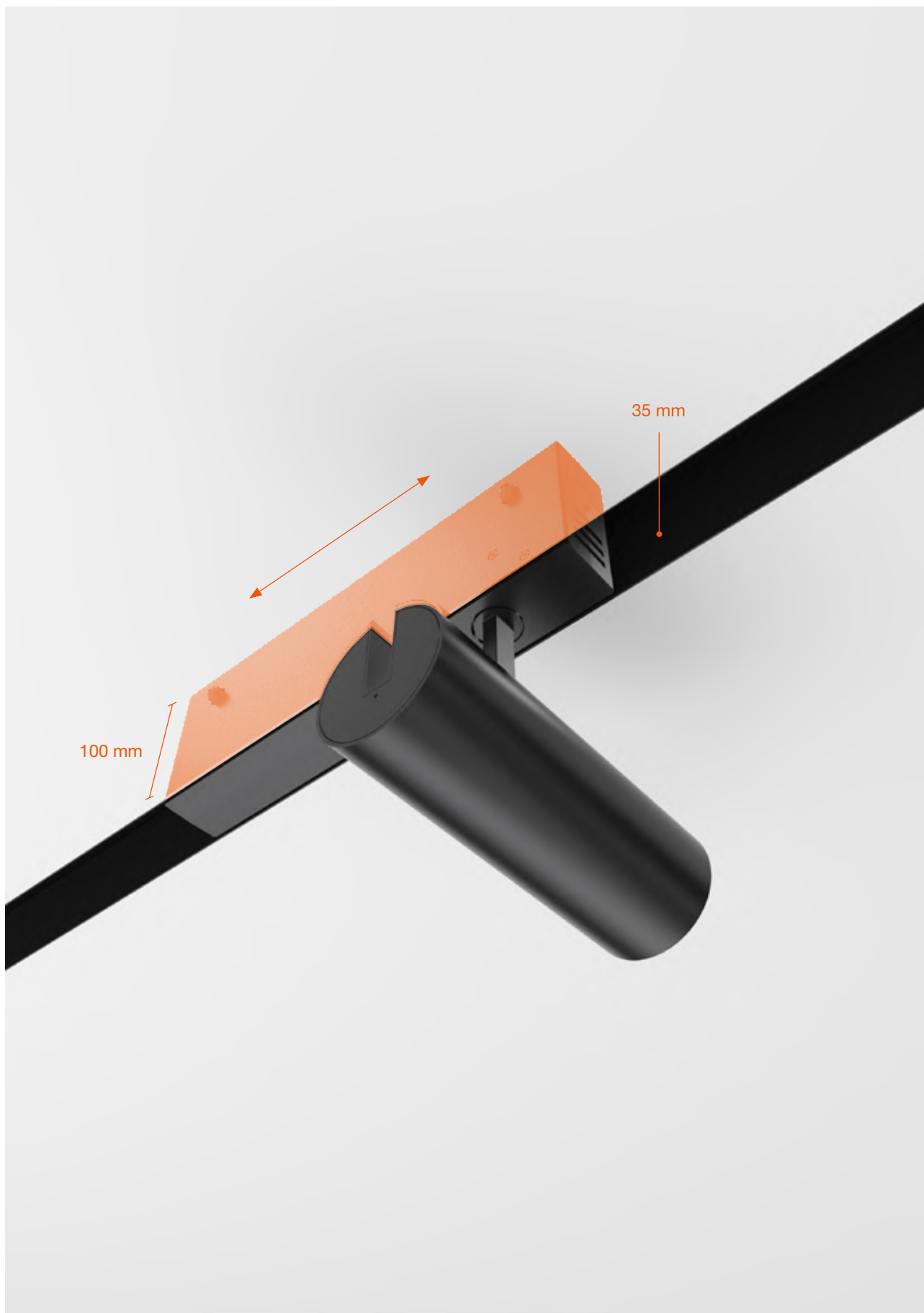



THE FAST TRACK 100

Una gamma completa di proiettori professionali: varie potenze, e ottiche da super spot a flood.

A complete range of professional spotlights: various power options, and optic from super spot to flood.

1 Dispone di versioni con ottica multi lente ad alta efficienza, con angoli fino a 4 gradi.
Versions with high-efficiency multi-lens optics with up to 4-degree angles are available.



1

THE FAST TRACK 150

2 Accessorio honeycomb per garantire il perfetto controllo visivo e schermatura.
Honeycomb accessory for a perfect visual control and shielding.



2



Grazie all'applicazione si può configurare ciascuno degli apparecchi di illuminazione, salvare il suo orientamento e generare una scena personalizzata.

Thanks to the application you can set up each luminaire, save their orientation and generate a lighting scenario.

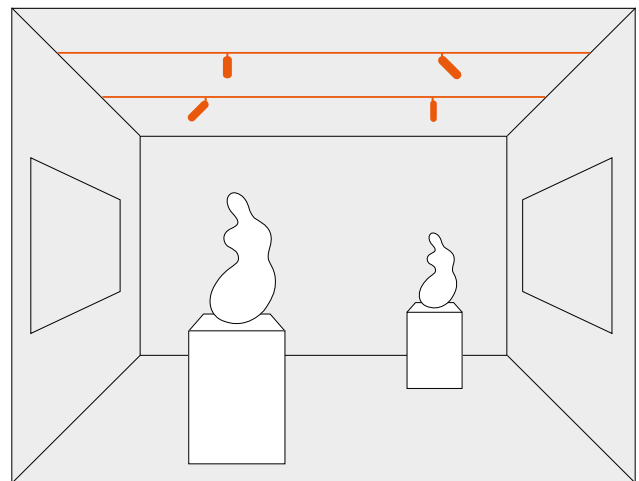
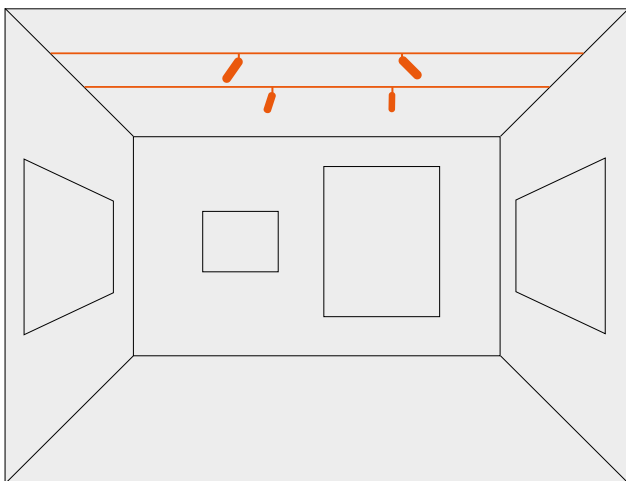

L'applicazione consente inoltre la gestione e l'attivazione programmata di scenari.

The application also offers the possibility of scenario management and scheduled activation.

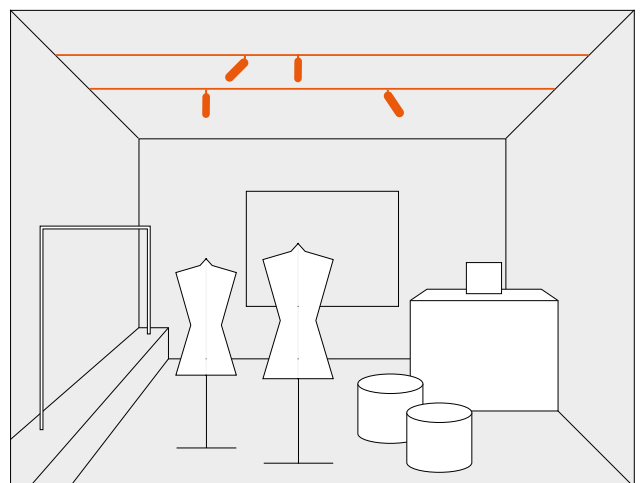
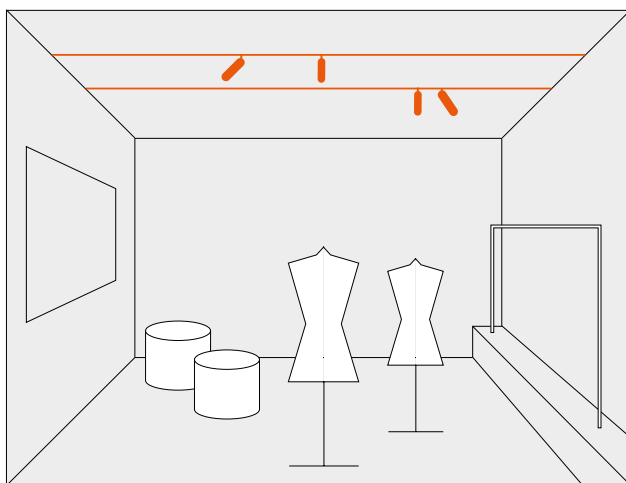
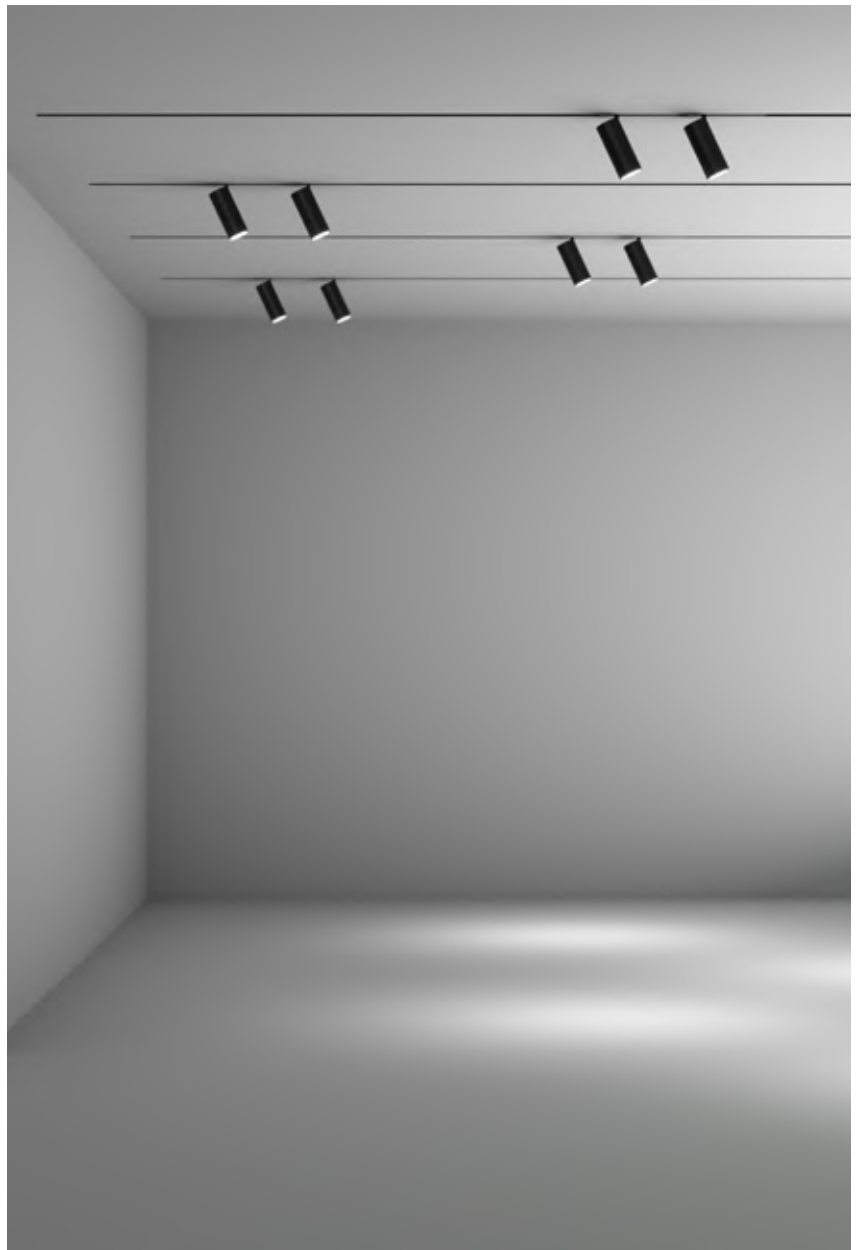



Arclinea Showroom, Italy

LIGHT MODULES

THE FAST TRACK
SPOT 100



POWER LED
13W

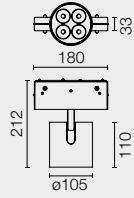

THE FAST TRACK
SPOT 150



LED ARRAY
25,5W

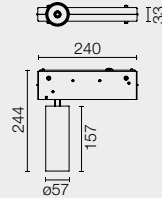

Super Spot



Spot



Medium



Flood

RECESSED



■ 14 Nero
14 Black

SURFACE



□ 40 Bianco
40 White ■ 14 Nero
14 Black



■ 14 Nero
14 Black



□ BW Bianco
BW White

MULTIFUNCTION
SMART DEVICE



FLOS CONTROL®
by Casambi

**W
WORKMATES
M**

Il concetto di ufficio tradizionale non è più lo *status quo* quando si tratta di spazi professionali. I nuovi modelli di lavoro ibrido ne hanno ridefinito le architetture, gli usi e le funzionalità. Workmates rappresenta l'ecosistema di apparecchi di illuminazione Flos pensato per i nuovi spazi di lavoro contemporanei e multidisciplinari.

The traditional office paradigm is no longer the *statu quo* for professional spaces. New hybrid models of working have redefined their architectures, uses and functionalities. Workmates is Flos' luminaire ecosystem for new contemporary and multidisciplinary work spaces.

WORKMATES

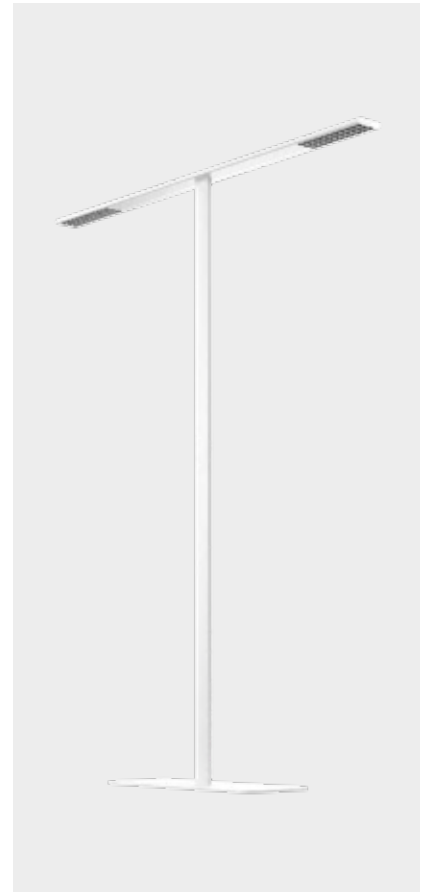
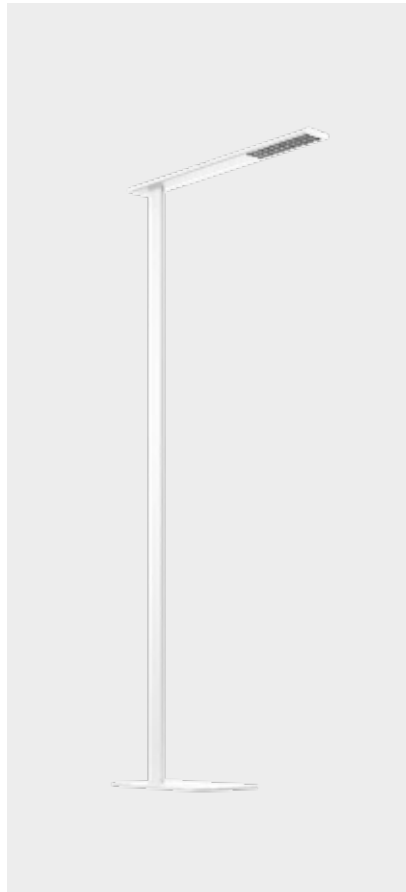
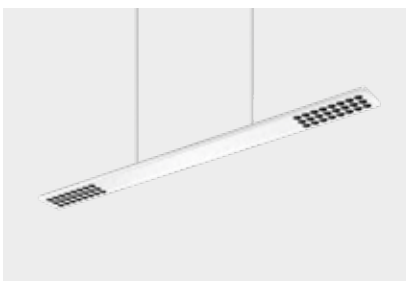

Una gamma di prodotti pensati per rispondere, con versatilità, a qualsiasi esigenza illuminotecnica. Un concetto di illuminazione che mette il benessere della persona al centro del suo sviluppo tecnico cui si aggiunge una minuziosa cura dell'estetica e dei dettagli che si diffonde dal carattere distintivo del design Flos. Workmates si declina in 4 opzioni di montaggio (a soffitto, a sospensione, da terra e a binario), così da adattarsi alle esigenze di installazione di tutti gli spazi.

A collection of products designed to answer any lighting need with versatility. A lighting concept that places personal well-being at the very core of its technical development and adds careful attention to the aesthetics and details that emanate from the differential identity of the Flos design. Workmates comes in 4 installation options (ceiling surface, suspension, floor and track), in order to adapt to the installation requirements of any space.

- 1 CEILING
- 2 TRACK
- 3 SUSPENSION
- 4 FLOOR DOUBLE
- 5 FLOOR SINGLE

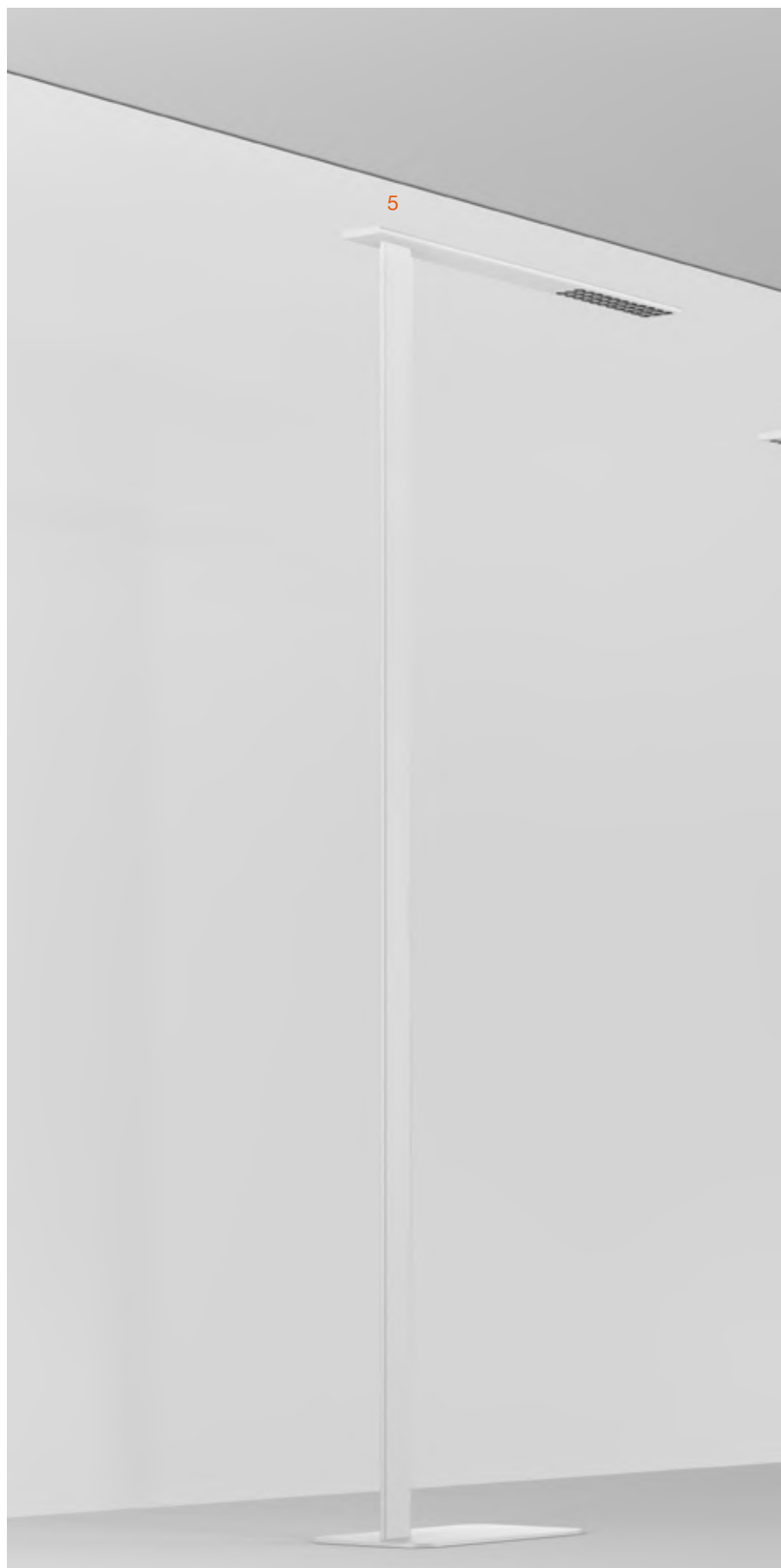



Lo spazio di lavoro non è più in contrasto con la bellezza del miglior design. I dettagli hanno valore e per questo motivo Workmates è genuinamente Flos. Con una presenza magnetica, è snello, minimalista, sottile... Workmates si presenta con una gamma di finiture selezionate: All White, White e Black. Inoltre, in tutti i modelli ad esclusione della versione da terra, è disponibile l'accattivante finitura Anodized Silver.

The workspace is no longer at odds with the beauty of optimal design. Details matter, and that is why Workmates is pure Flos. With its magnetic presence, it is slim, minimalist, subtle... Workmates comes in a range of select finishes: All White, White and Black. In addition, the attractive Anodized Silver finish is available in all models except the floor option.















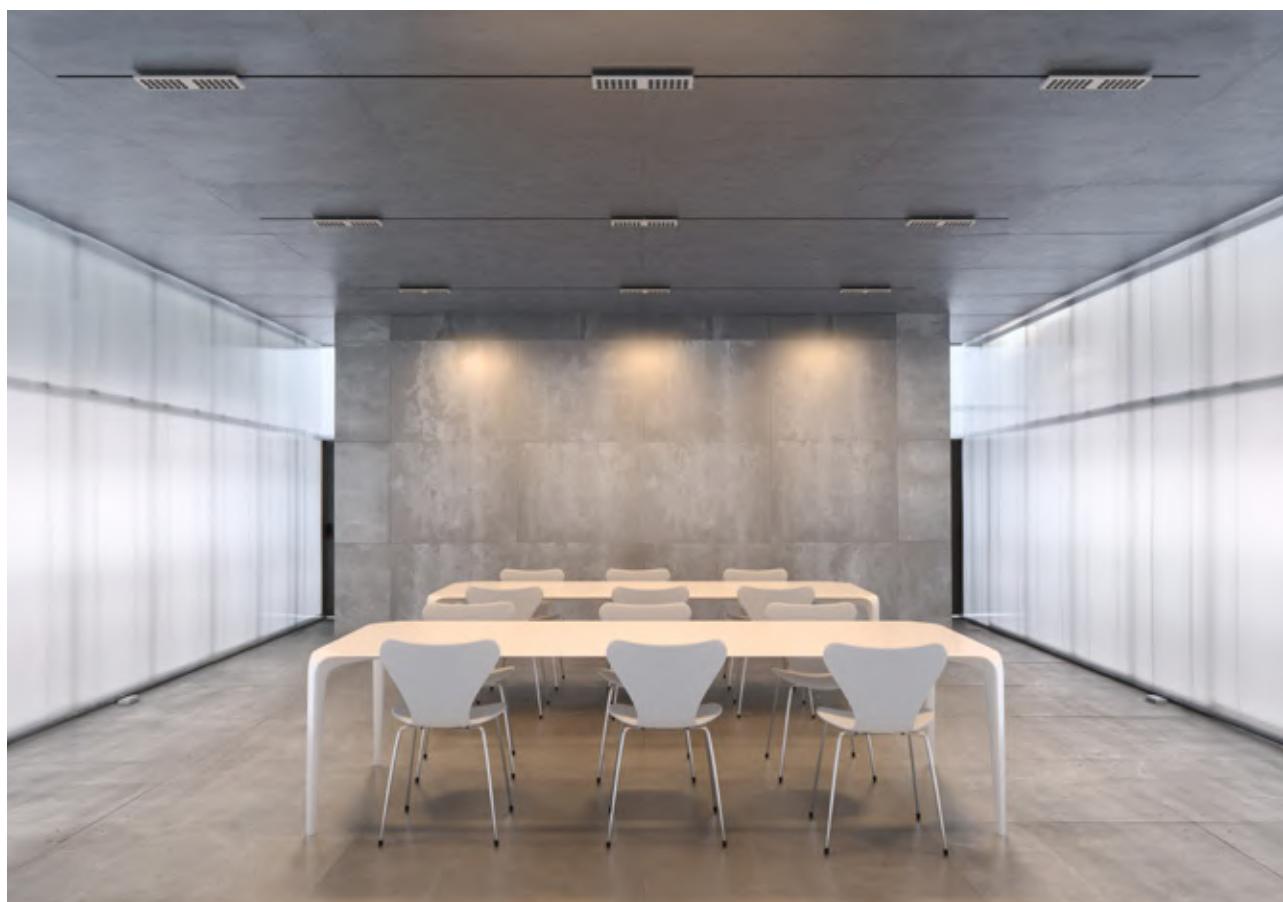

HUMAN CENTRIC LIGHTING

I modelli *Smart*, con emissione indiretta di CCT variabile *Tunable White*, consentono la modulazione intelligente della temperatura di colore della luce al fine di conciliarla con il ritmo circadiano in base all'orario della giornata e favorire il benessere e la salute nell'ambiente di lavoro.

Smart models with indirect *Tunable White* variable CCT emission enable the *Smart* modulation of the light's colour temperature to assist with circadian entrainment depending on time of day, promoting well-being and health at work.

VISUAL COMFORT · OFFICE REGULATIONS COMPLIANCE

Workmates rispetta le più stringenti norme in materia di comfort visivo negli uffici. Pertanto nell'angolo di 65° (normale posizione di una persona seduta alla scrivania rispetto alla lampada), l'intensità non supera le 3.000 cd/m².

Workmates meets the strictest standards in terms of visual comfort for offices. So at a 65° angle (the normal position of someone sitting at a desk compared with a lamp), the intensity does not exceed 3,000 cd/m².

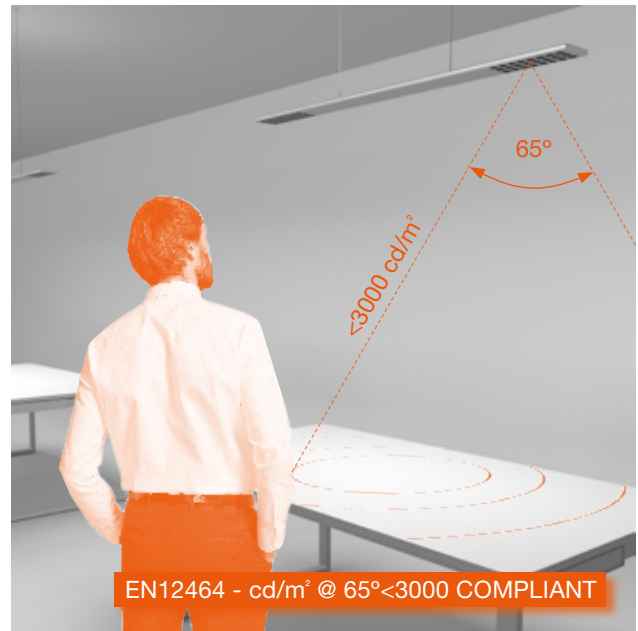
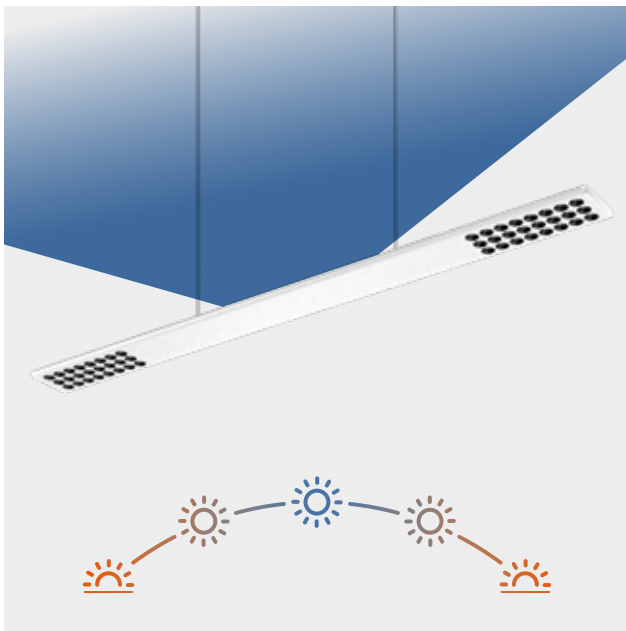



SMART LIGHTING

I sistemi di controllo *Dali* e senza fili *Casambi*, dotano Workmates di sensori integrati o esterni per mettere in scena la luce desiderata per ogni situazione. Tutto ciò, in risposta al rilevamento della presenza¹, dell'assenza¹ o alle soglie² di luminosità desiderate.

With its *Dali* and wireless *Casambi* control systems, Workmates has built-in or external sensors to activate the desired lighting scenarios for each situation. All of it triggered by presence¹ or absence¹ detection, or the desired brightness² thresholds.

DEDICATED LIGHT EMISSION

Ogni modello di Workmates offre le *moDalità* di distribuzione luminosa necessarie stando alle specifiche applicazioni negli spazi di lavoro. A seconda del modello, è disponibile la distribuzione *wide flood*, *ovale* o *asymmetric* per emissione *Down* e *Extra Wide flood* per emissione *Up*.

Each Workmates model offers of the necessary light distribution forms for applications that are required in workspaces. Depending on the model, *wide flood*, *oval* or *asymmetric* distributions are available for *Down* emission, and *Extra Wide flood* for *Up* emission.

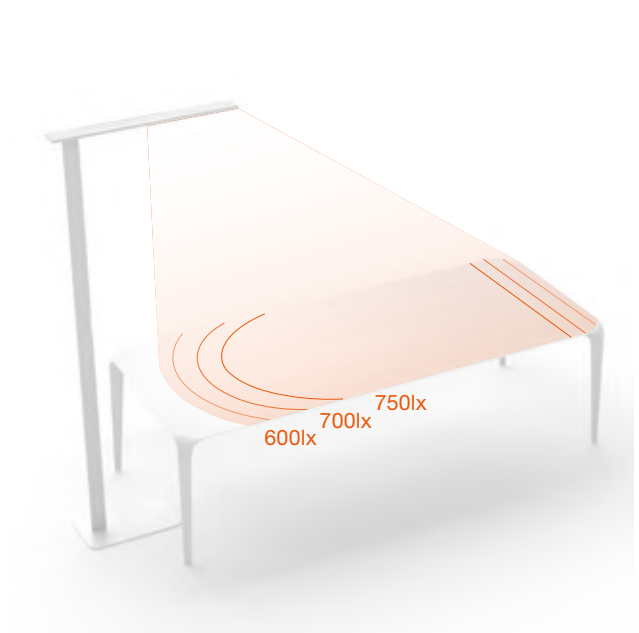
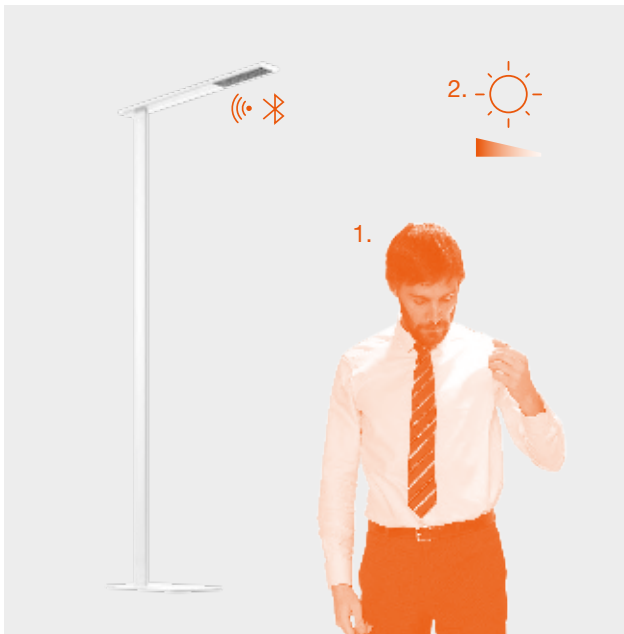









Tutte le luci dell'ecosistema Workmates sono dotate di sorgenti luminose LED *High Efficiency* e *Full Spectrum*. Con la prima si ottiene un rendimento eccellente in termini di Lm/W, mentre con l'opzione *Full Spectrum* si raggiunge un indice *NLAS (Natural Light Average Secondment)* perfetto.

All'interno dello spettro visibile della radiazione luminosa, la luce naturale descrive un percorso molto preciso. La opzione a LED "*Full Spectrum*", disponibile per Workmates, rispecchia il comportamento più fedele di una luce artificiale rispetto al rendimento della luce naturale. In questo modo contribuisce a migliorare il benessere umano e a rispettare gli schemi naturali dell'illuminazione circadiana.

All the lights in the Workmates ecosystem are fitted with *High Efficiency* and *Full Spectrum* LED light sources. With the former, you get excellent performance in terms of lm/W, while with the *Full Spectrum* option, you get the perfect *NLAS (Natural Light Average Secondment)* index.

Natural light sets a very precise path within the visible light spectrum. The "*Full Spectrum*" LED option, available for Workmates, reflects the most accurate behaviour of artificial light compared with the performance of natural light. It therefore helps improve human well-being and respect the natural schemes of circadian lighting.

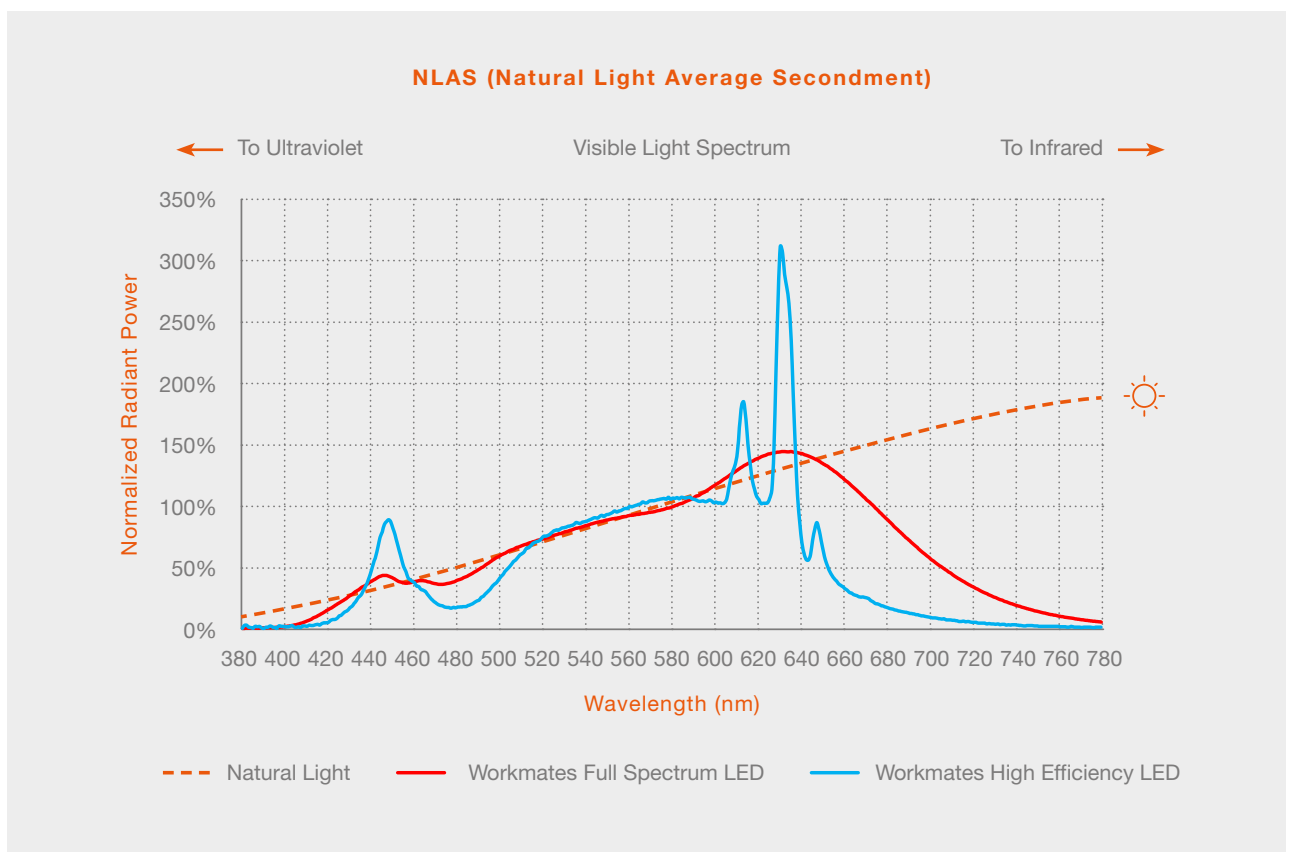



Diverse opzioni di controllo per la regolazione di WORKMATES.

Different control options for dimming WORKMATES.

Touch Dimming

Le versioni da terra vantano una pulsantiera capacitiva integrata per il controllo della luce.

The floor versions have an integrated capacitive keypad to control the luminaire.

DALI

Protocollo standard per l'integrazione con qualsiasi sistema di controllo.

Standard protocol for integration with any control system.

CASAMBI

Controllo direttamente attraverso un'applicazione per tablet e smartphone (FLOS Control®).

Control through a tablet or smartphone application (FLOS Control®).

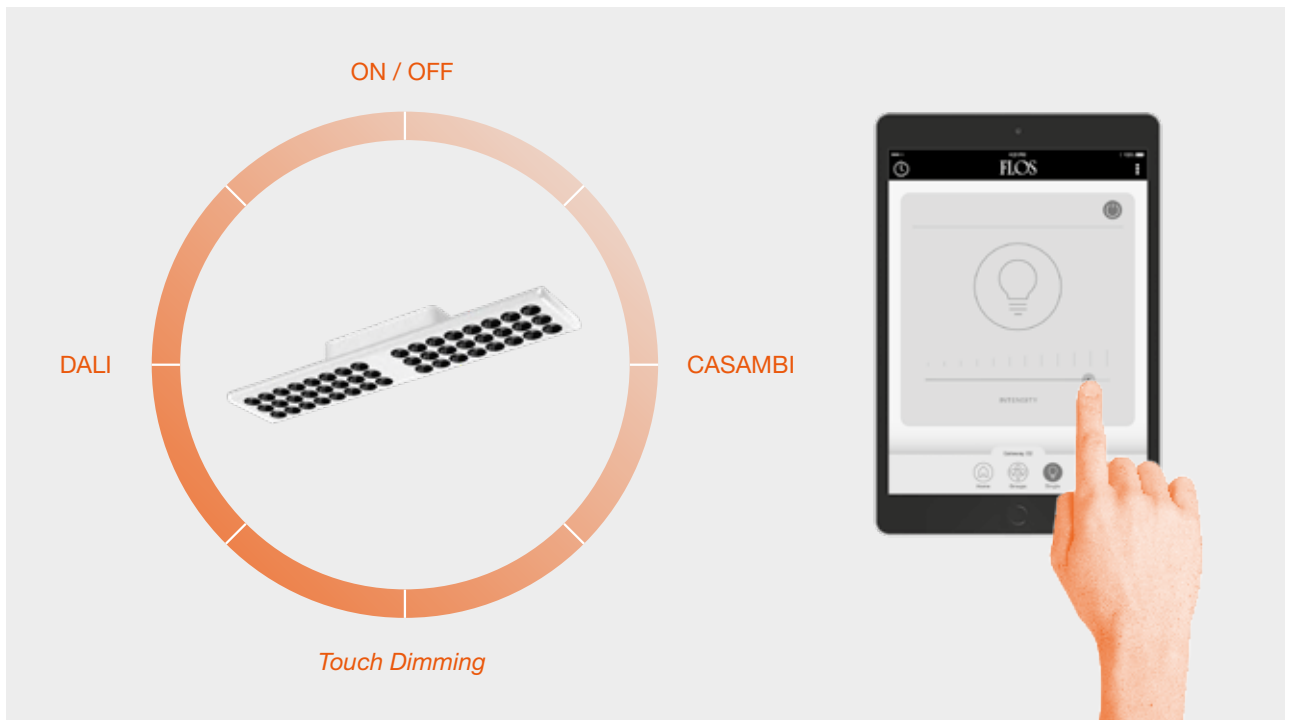

FLOS CONTROL® BY CASAMBI

L'applicazione FLOS Control® consente di controllare gli apparecchi di illuminazione del sistema in gruppo, controllando scene e programmazione.

The FLOS Control® application allows you to control the system's luminaires as a group, controlling scenes and programming.

In un impianto elettrico tradizionale, con il gateway connesso via Bluetooth si ottiene un controllo totale dell'ambiente.

With a traditional electrical installation and the Gateway connected by Bluetooth, you obtain total control of the ambience.

Disponibile per iOS e Android

Available for iOS and Android

WORKMATES SURFACE
SMALL



PRELIMINARY
15W

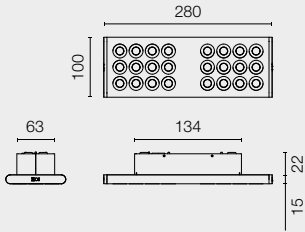

WORKMATES SURFACE
LARGE



PRELIMINARY
22W

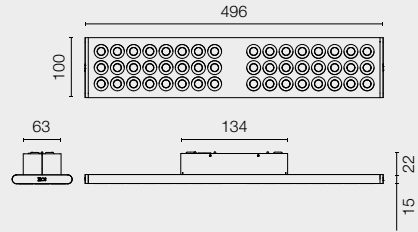

WORKMATES TRACK
SMALL



POWER LED
Up to 15,5W

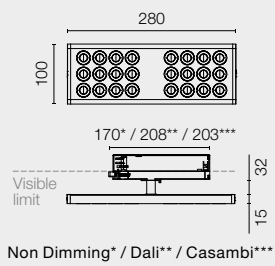

WORKMATES TRACK
LARGE



POWER LED
Up to 22W

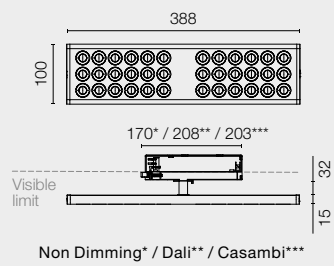

WORKMATES IN-TRACK
SMALL



POWER LED
Up to 15,5W

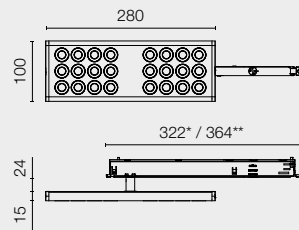

Non Dimming* / Dali**

WORKMATES IN-TRACK
LARGE



POWER LED
Up to 22W

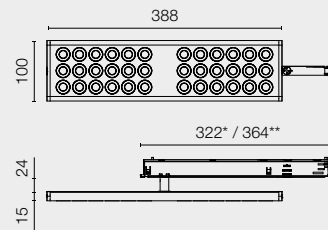

Non Dimming* / Dali**

THE RUNNING MAGNET

WORKMATES SMALL



WORKMATES LARGE



* Vedi capitolo The Running Magnet / Refer to The Running Magnet chapter

WORKMATES SUSPENSION

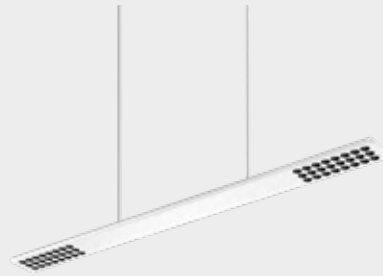

COMING SOON

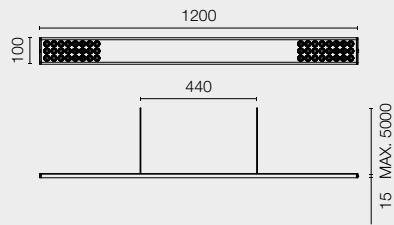

Wide Flood



Oval



Up&Down



Asymmetrical

WORKMATES FLOOR
SINGLE

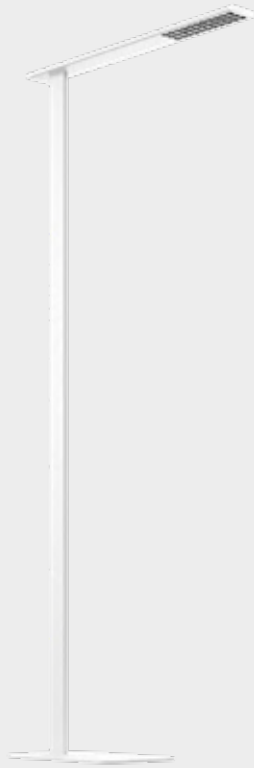

COMING SOON

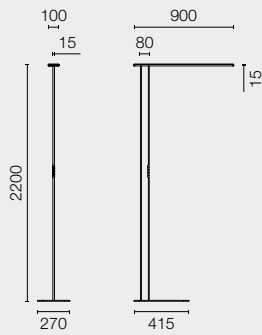

WORKMATES FLOOR
DOUBLE



COMING SOON

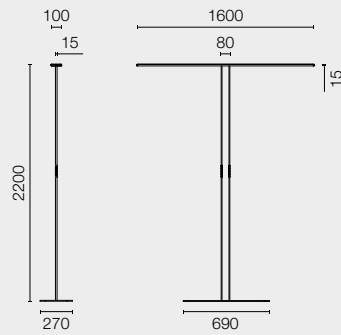

Programma dalle dimensioni compatte disegnato per evitare abbagliamenti. Varietà di ottiche, dimensioni e finiture. Grande controllo grazie al suo gruppo ottico brevettato.

Compact size program designed to avoid glare. Variety of optics, sizes and finishes. Great control thanks to its patented optical group.

LIGHT SHADOW

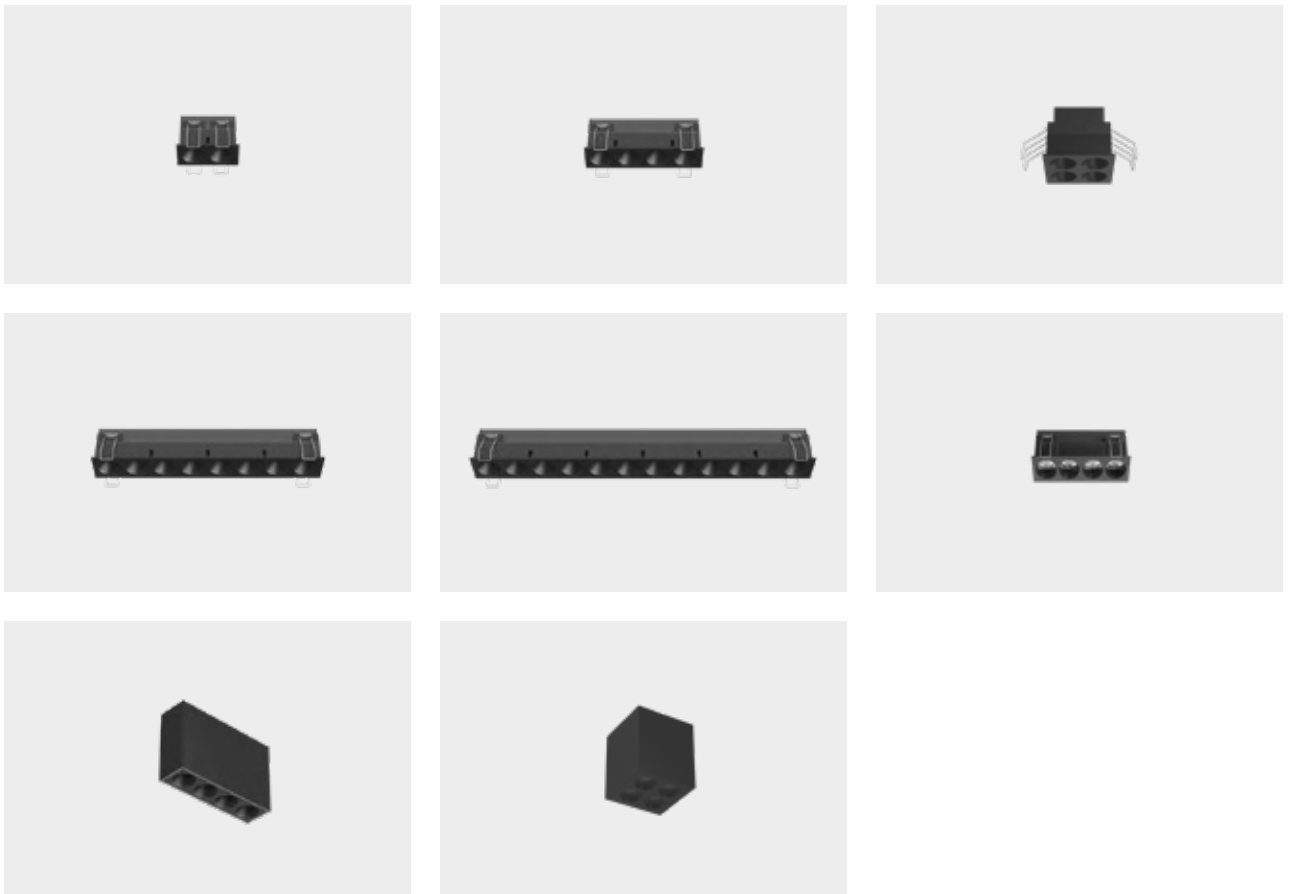





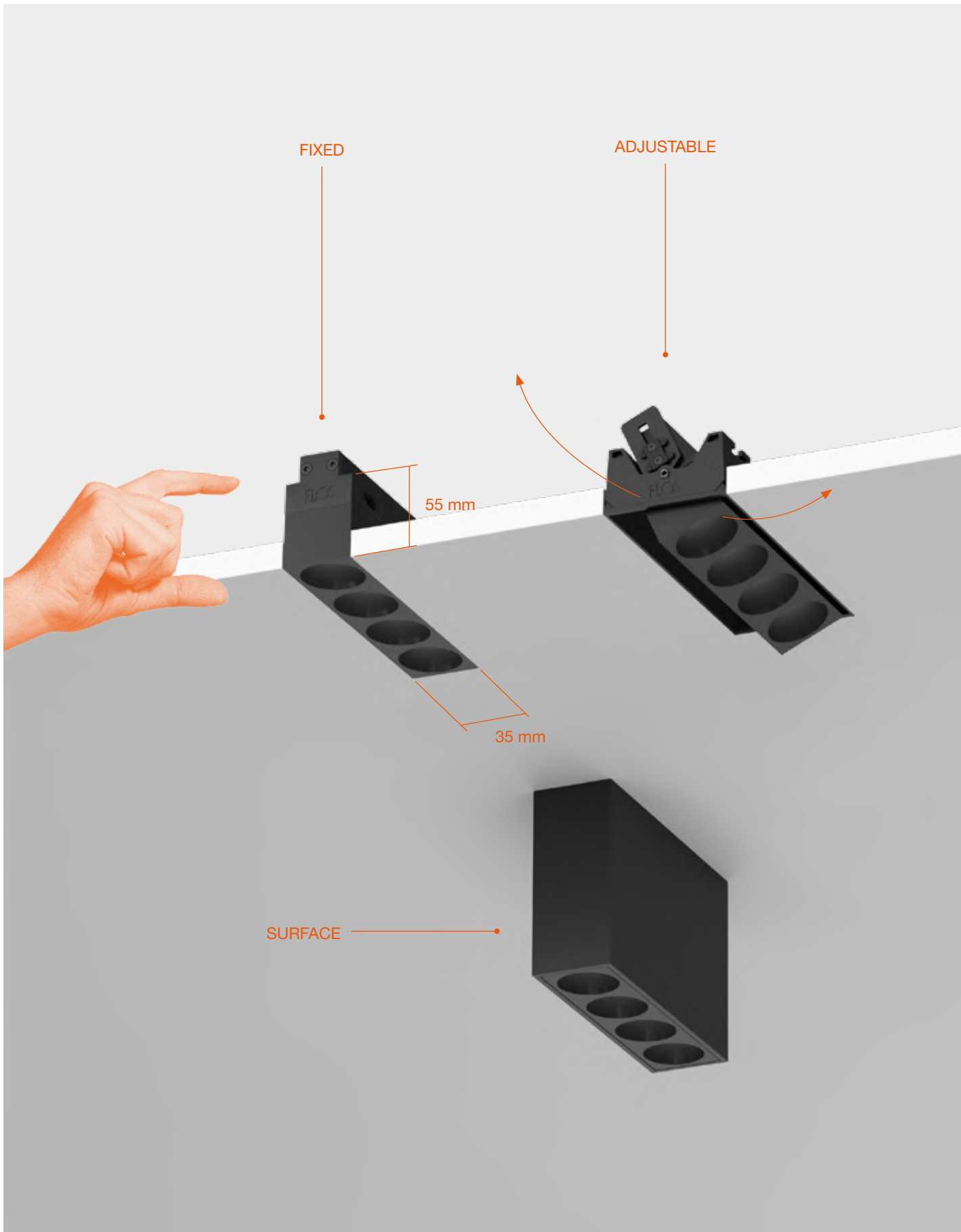

WALL-WASHER

SQUARE

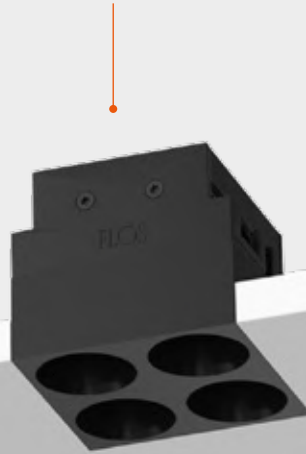
SURFACE
SQUARE

Dimensioni extra compatte che permettono l'integrazione incassata anche in caso di spazio minimo disponibile. La versione regolabile consente di estrarre il corpo principale per garantire una perfetta integrazione con gli elementi architettonici e sfruttare tutto il fascio.

Extra-compact size which allows embedded integration, even when there is minimum space available. The adjustable version allows the main body to be extracted to guarantee perfect integration with the architecture, and to make the most of the whole beam.

TRADITIONAL TECHNOLOGY

Con la tecnologia tradizionale si ottiene un effetto di abbagliamento e, al contempo, il fascio di luce non è molto preciso. Scarsa l'integrazione con gli elementi architettonici.

The traditional technology produces a glare effect while the beam of light is not so precise. Integration with architecture is not achieved.

GLARE

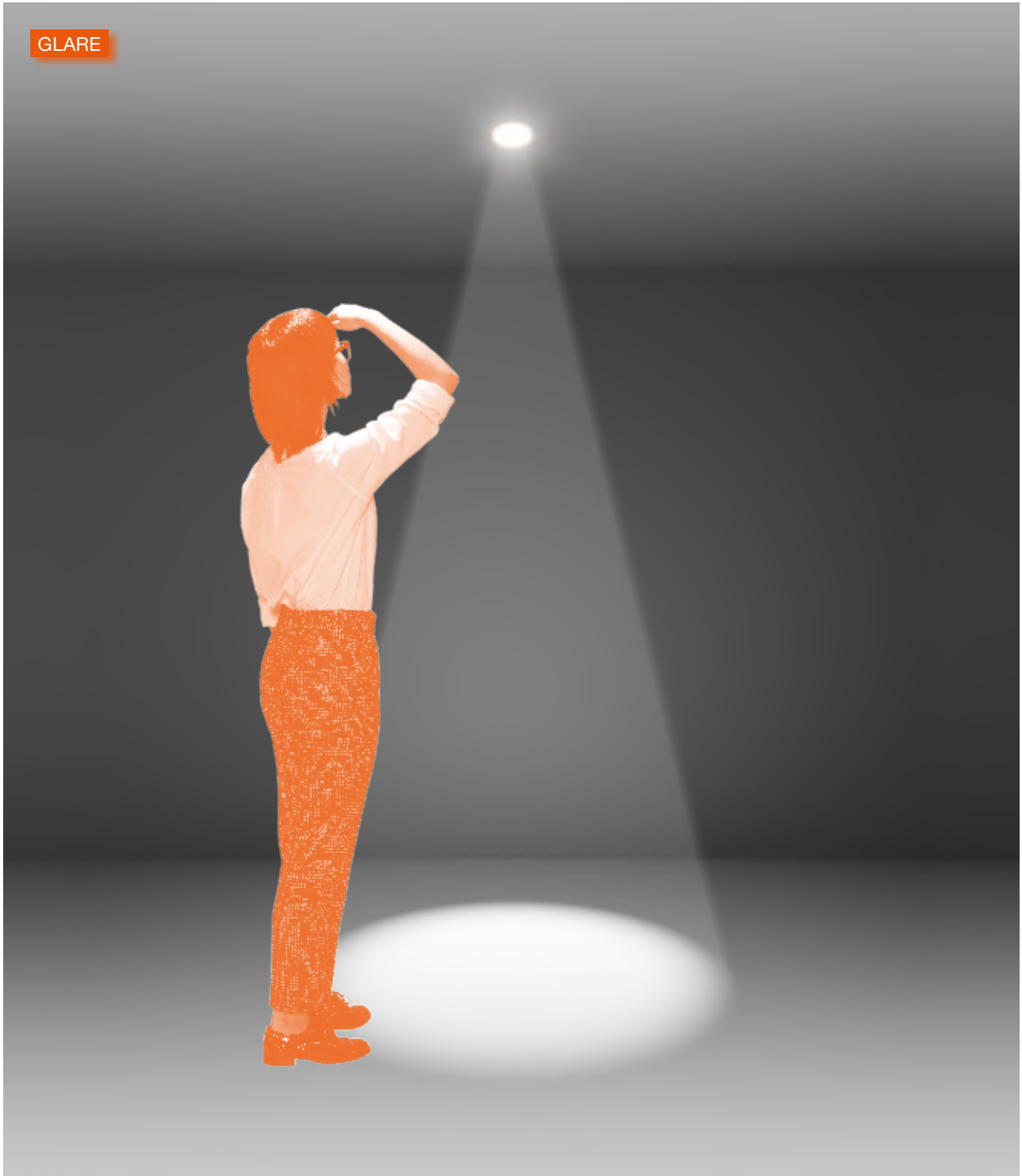

FLOS TECHNOLOGY

Con la tecnologia del Light Shadow che fornisce un cut-off di 45 gradi, la massima integrazione con gli elementi architettonici si abbina a un fascio di luce definito e impeccabile e a una schermatura totale, fatto che consentendo di collocarlo in posizione quasi zenitale senza generare abbagliamenti.

Light Shadow technology thanks to its cut-off of 45 degrees, maximum integration with architecture combines with the impeccable, defined beam of light and total shielding, which allows it to be placed almost in zenithally position with no glare.

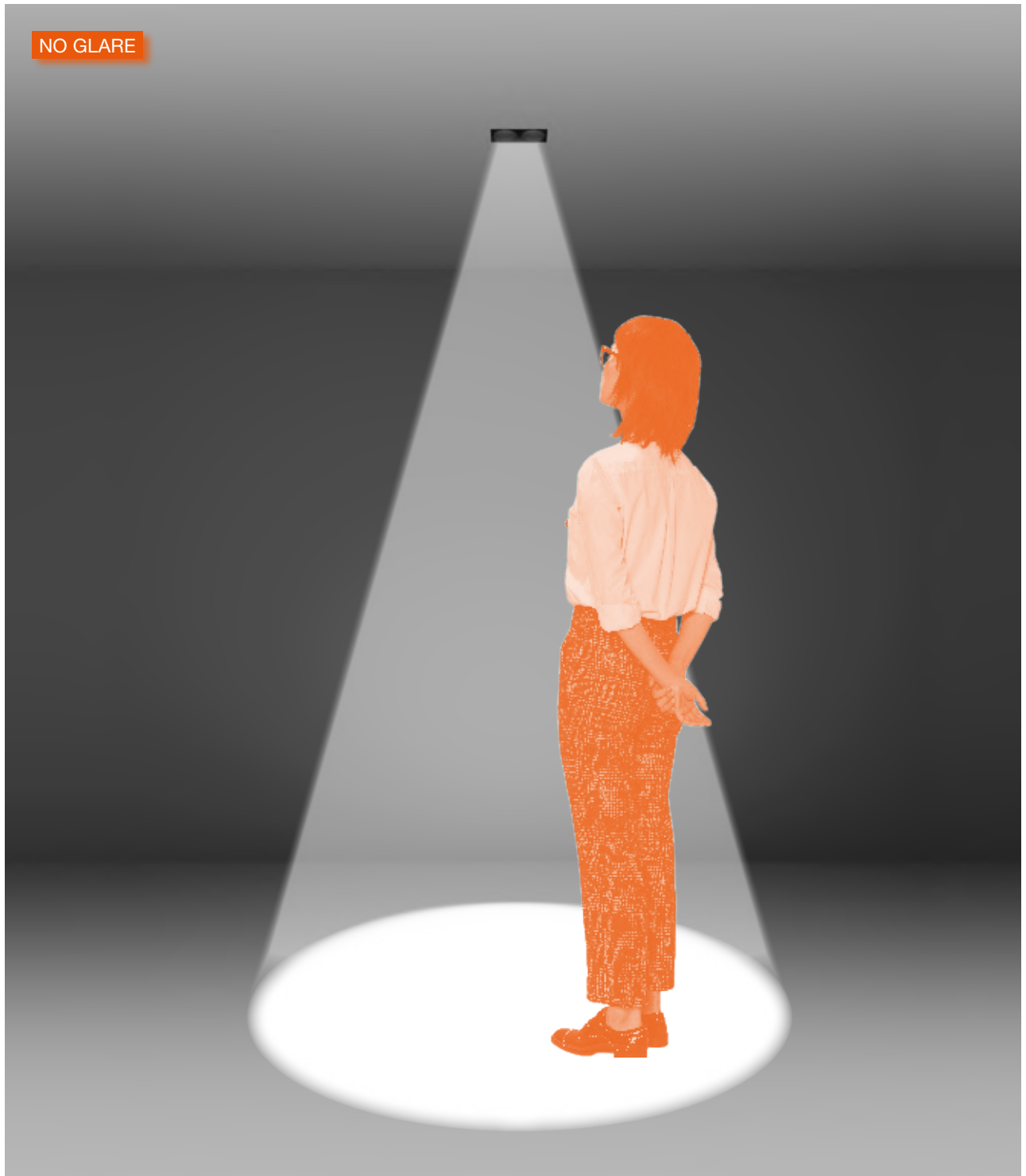

La rivoluzione nell'illuminazione senza abbagliamento. Grazie alla sua soluzione ottica esclusiva brevettata, Light Shadow arriva ad angoli di cut-off estremi, senza rinunciare all'alta efficienza e a dimensioni molto ridotte.

The revolution in low glare lighting. Thanks to its patented unique optical solution, Light Shadow reaches extreme cut-off angles without sacrificing high efficiency and very small dimensions.



1 Scheda LED disegnata da FLOS con moduli LED di ultima generazione. Alta qualità ed efficienza. LED board designed by FLOS with state-of-the-art LED modules. High levels of quality and efficiency.

2 Lenti sviluppate da FLOS specificatamente per questo prodotto, che garantisce il massimo controllo e un fascio di luce omogeneo. Lenses developed by FLOS especially for this product, to guarantee maximum control and a uniform beam.

3 Innovativo sistema brevettato di coni che forniscono una schermatura estrema grazie alla loro forma curva invertita. Innovative patented cones system that provides extreme shielding thanks to its inverted curve form.





Light Shadow arriva ad angoli di cut-off estremi, senza rinunciare all'alta efficienza e a dimensioni molto ridotte.

Light Shadow reaches extreme cut-off angles without sacrificing high efficiency and very small dimensions.

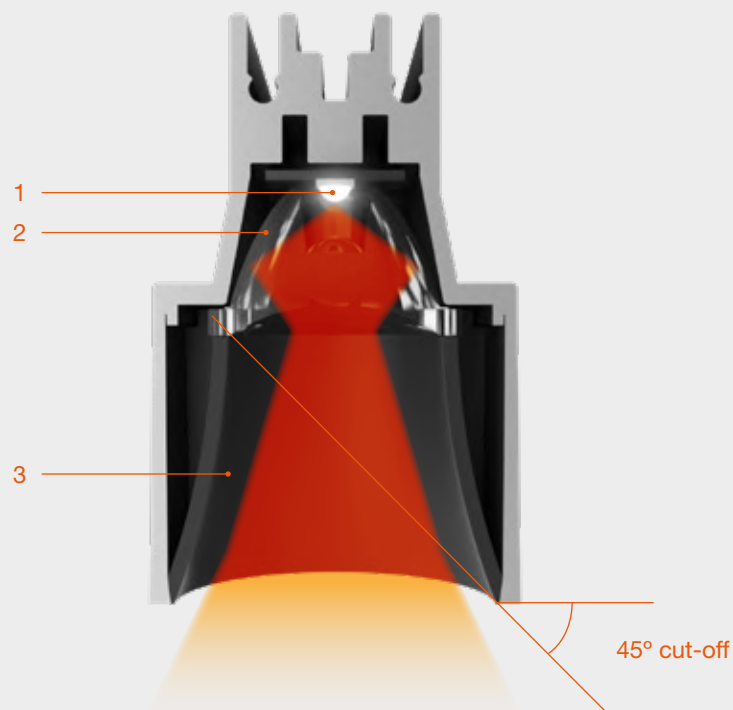

1 Scheda chip integrata.
Integrated chip board.

2 Lente.
Lens.

3 Cono di schermatura.
Screening cone.

L'eccellenza del comfort: UGR inferiore a 10 per un'eccezionale protezione dall'abbagliamento, omogeneità nella distribuzione della luce e prestazioni in termini di lux conformi ai più severi standard del settore.

The excellence of comfort: UGR below 10 for outstanding glare protection, homogeneity in light distribution and delivered lux compliant to the most strict standards of the industry.

PROGETTO TIPO

Ambiente 20m x 10m, h 2,7m.
Versione utilizzata: Light Shadow 4L Flood Optic Dali dimmable.

Interdistanza apparecchi: 1,2 m

Parametri illuminotecnici:
UGR < 10 da qualsiasi punto di osservazione (UGR < 19 valore minimo normativo).

Illuminamento medio: 551 lx
(500 lx valore minimo normativo).

Uniformità ottenuta: 0,655
(0,600 valore minimo normativo).

Norma di riferimento:
UNI-EN 12464-1:2011

PROJECT TYPE

Ambient 20m x 10m, h 2.7m.
Version used: Light shadow 4L Flood Optic Dali dimmable.

Spacing between luminaires: 1.2 m

Technical brightness parameters:
UGR < 10 from any point of observation
(UGR < 19 standard minimum value).

Average brightness: 551 lx
(500 lx standard minimum value).

Uniformity obtained: 0.655
(0.600 standard minimum value).

Reference standard:
UNI-EN 12464-1:2011

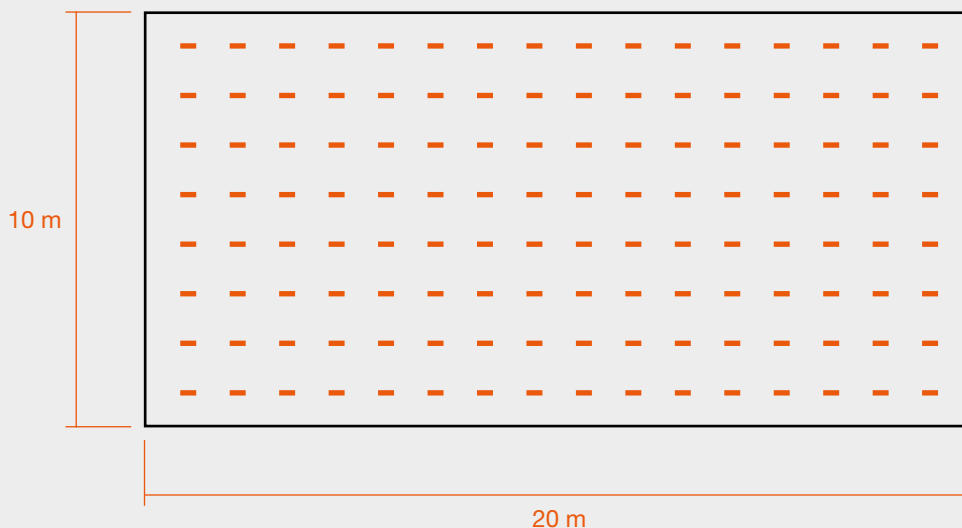

NO GLARE







Light Shadow è anche disponibile per installazione magnetica sull'esclusivo binario The Running Magnet di Flos: flessibilità e adattabilità in qualunque momento. Vedere il catalogo Flos per i dettagli completi sulla collezione The Running Magnet.

Light Shadow is also available for magnetic installation in Flos exclusive The Running Magnet track: flexibility and adaptability at any time. See Flos catalogues for complete details about The Running Magnet collection.





Effetto di luce morbida e controllata sviluppato per illuminare in maniera uniforme qualsiasi piano verticale. Il nuovo modulo wall-washer completa il programma con una soluzione altamente professionale mantenendo intatto il comfort visivo elevato che caratterizza il programma.

Soft and controlled lighting effect, developed to uniformly light up any vertical plane. The new wall-washer module completes the program with an extremely professional solution that preserves the high visual comfort that characterizes the program.

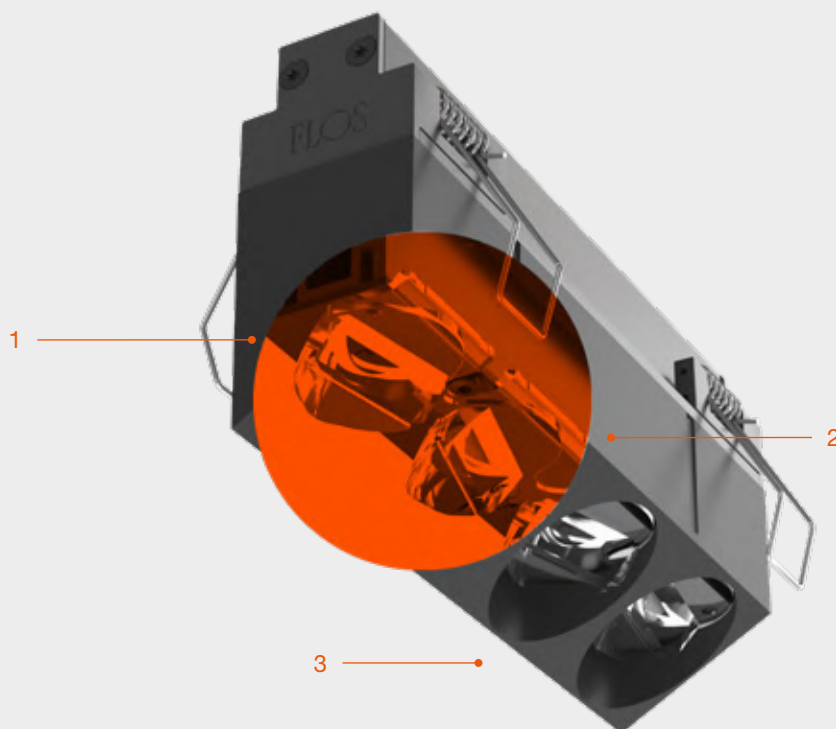

1 Speciale lente asimmetrica progettata per una perfetta distribuzione verticale dell'emissione luminosa.

Special asymmetric lens, designed for a perfect vertical distribution of the light emission.

2 Lenti ruotate singolarmente per coprire una superficie di illuminazione maggiore e incrementare l'omogeneità della luce.

Individually rotated lenses in order to cover a larger lighting surface and to increase the homogeneity of the light.

3 Palpebra integrata per evitare fenomeni di abbagliamento indesiderati.

Integrated screen that avoids undesirable glare effects.

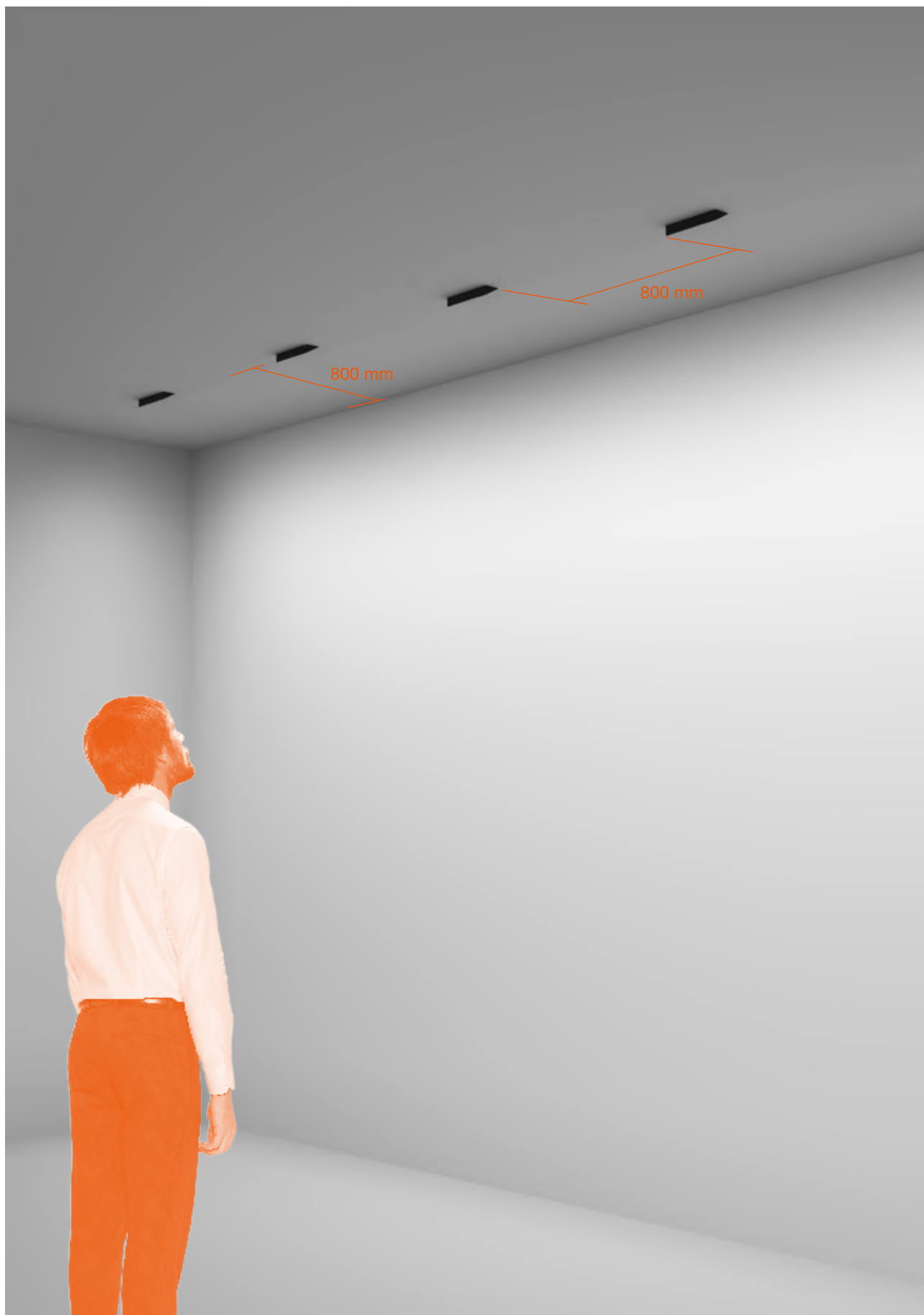

FIXED
TRIM / NO TRIM
2 SPOTS



POWER LED
3,5W x SPOT



FIXED
TRIM / NO TRIM
4 SPOTS



POWER LED
2,7W x SPOT

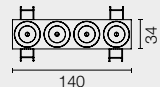
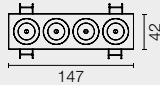

FIXED
TRIM / NO TRIM
4 SPOTS SQUARE



POWER LED
2,7W x SPOT

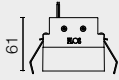
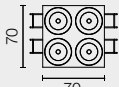
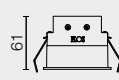
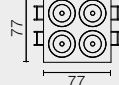

FIXED
TRIM / NO TRIM
8 SPOTS

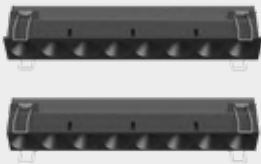

POWER LED
2,7W x SPOT

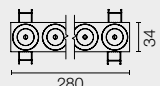
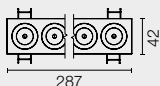

FIXED
TRIM / NO TRIM
12 SPOTS

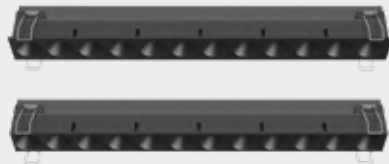

POWER LED
2,7W x SPOT

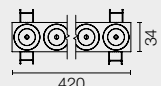
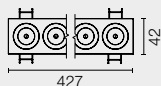

LIGHT SHADOW FIXED / ADJUSTABLE / SURFACE

Internal Finish



External Plate Finish

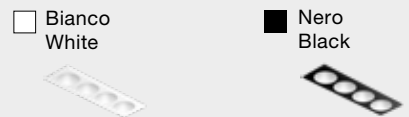

LIGHT SHADOW WALL-WASHER

External Plate Finish



LIGHT SHADOW SURFACE

Box Finish

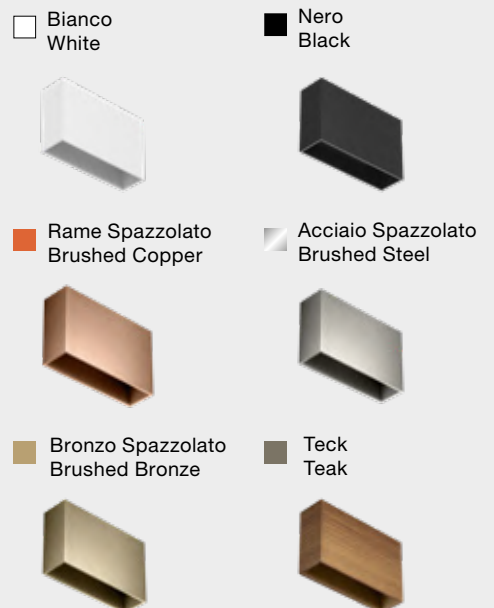

Spot



Medium



Flood



Wide Flood



Wall-Washer

ADJUSTABLE TRIM / NO TRIM
2 SPOTS



POWER LED
3,5W x SPOT

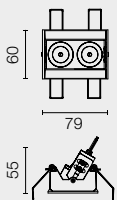
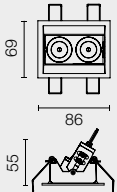

ADJUSTABLE TRIM / NO TRIM
4 SPOTS



POWER LED
2,7W x SPOT

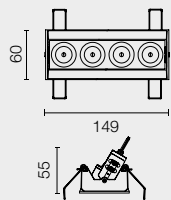
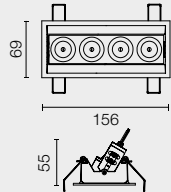

ADJUSTABLE TRIM / NO TRIM
8 SPOTS



POWER LED
2,7W x SPOT

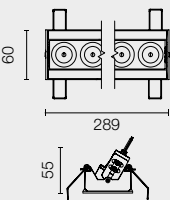
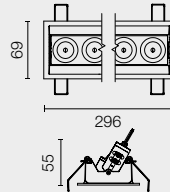

ADJUSTABLE TRIM / NO TRIM
12 SPOTS



POWER LED
2,7W x SPOT

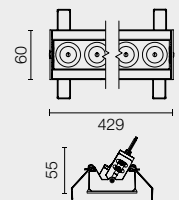
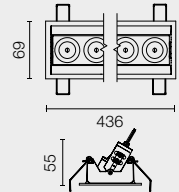

WALL-WASHER TRIM / NO TRIM
4 SPOTS



POWER LED
2,7W x SPOT

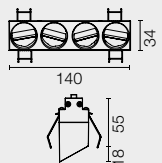
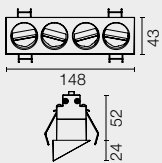

SURFACE 4 SPOTS



POWER LED
2,7W x SPOT

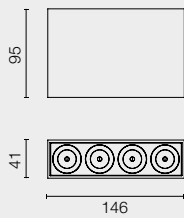

SURFACE SQUARE 4 SPOTS



POWER LED
2,7W x SPOT

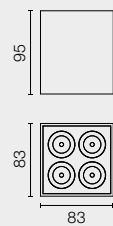

LIGHT SHADOW
*compatible module for
The Running Magnet



POWER LED
2,7W x SPOT

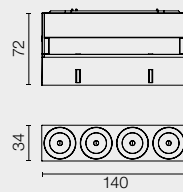

LIGHT SHADOW W-W
*compatible module for
The Running Magnet



POWER LED
2,7W x SPOT

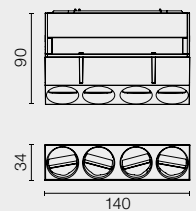

*Verificare moduli compatibili per la collezione The Running Magnet /
See compatible modules for The Running Magnet collection

LIGHT SHADOW
LIGHT SHADOW
LIGHT SHADOW
LIGHT SHADOW
LIGHT SHADOW
LIGHT SHADOW
LIGHT SHADOW
LIGHT SHADOW

U
O
T
S

O
R
P

LIGHT SHADOW
LIGHT SHADOW
LIGHT SHADOW
LIGHT SHADOW
LIGHT SHADOW

Programma di downlights rivoluzionario sviluppato per controllare l'abbagliamento in innumerevoli applicazioni. L'esclusivo sistema ottico brevettato è stato declinato in molteplici aperture di fascio realizzate ad hoc per applicazioni specifiche quali Uffici, Retail e ambienti domestici.

Revolutionary downlights program developed to control glare in countless applications. The unique patented optical system has been applied to multiple custom-made beamwidths for specific applications such as offices, shops and homes.

LIGHT SHADOW DOTS & PRO







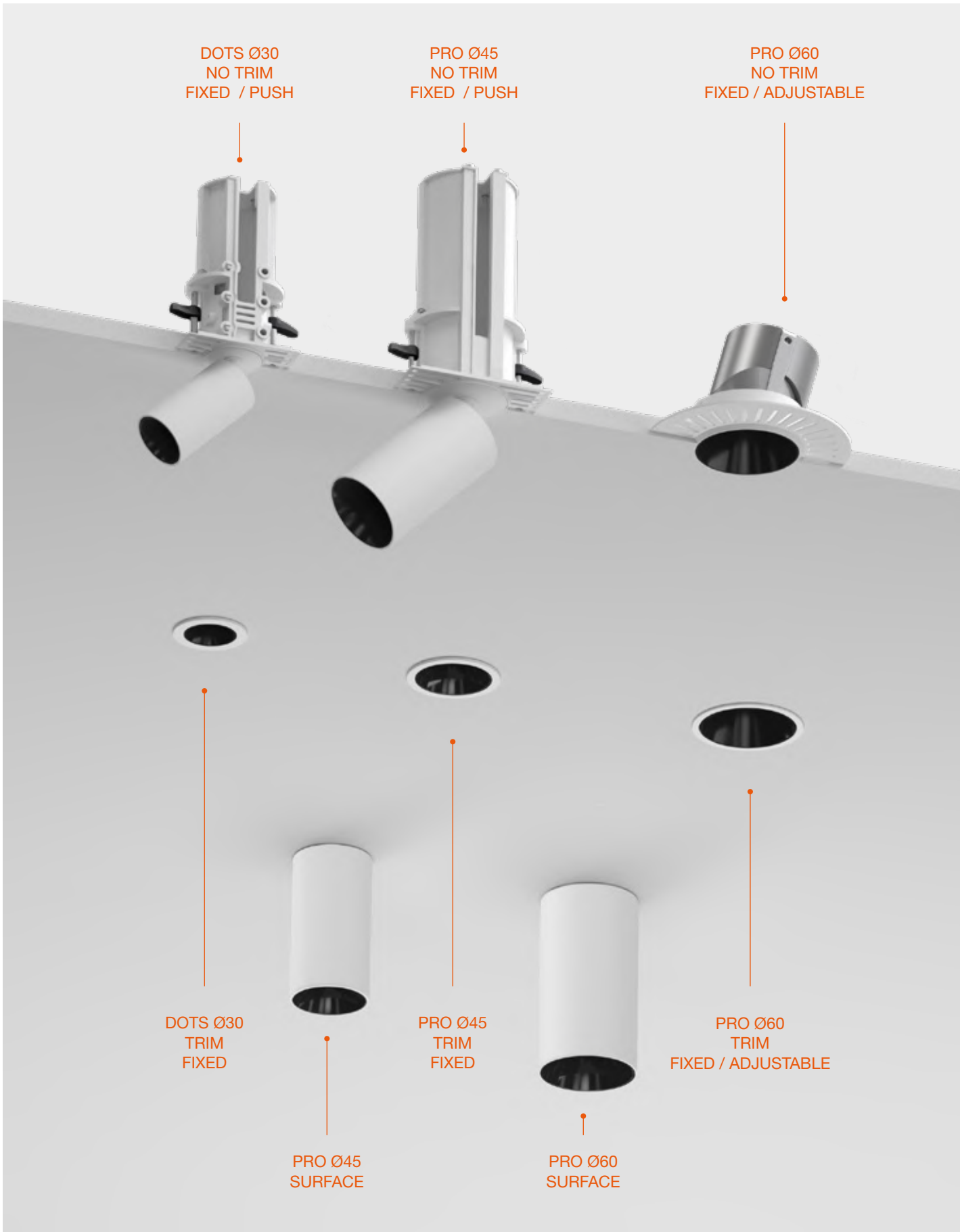

PRO Ø90
NO TRIM
FIXED / ADJUSTABLE

PRO Ø90
NO TRIM
WALL-WASHER



PRO Ø90
TRIM
FIXED / ADJUSTABLE



PRO Ø90
TRIM
WALL-WASHER

Un approccio completamente nuovo nell'ambito dell'illuminazione architettonica. Porta il controllo dell'abbagliamento a un livello estremo in cui i valori di efficienza ottica sono estremamente elevati grazie all'uso di tecnologie di ultima generazione e la qualità della luce raggiunge standard ancor più elevati e ricercati.

A completely new approach to architectural lighting. It takes glare control to the next level. Optical efficiency values are extremely high thanks to the use of the latest generation technologies and the light quality reaches even higher and more refined standards.

LIGHT SHADOW DOTS

Il più piccolo downlight del programma. 30mm di diametro e una profondità d'incasso estremamente ridotta sono abbinati ad un complesso sistema ottico che fornisce una schermatura estrema della sorgente grazie alla forma invertita dei coni cut-off che lo caratterizzano.

The smallest downlight in the range. A 30 mm diameter and an extremely reduced recess depth are combined with a complex optical system that provides extreme shielding of the source thanks to the inverted shape of the cut-off cones that characterize it.

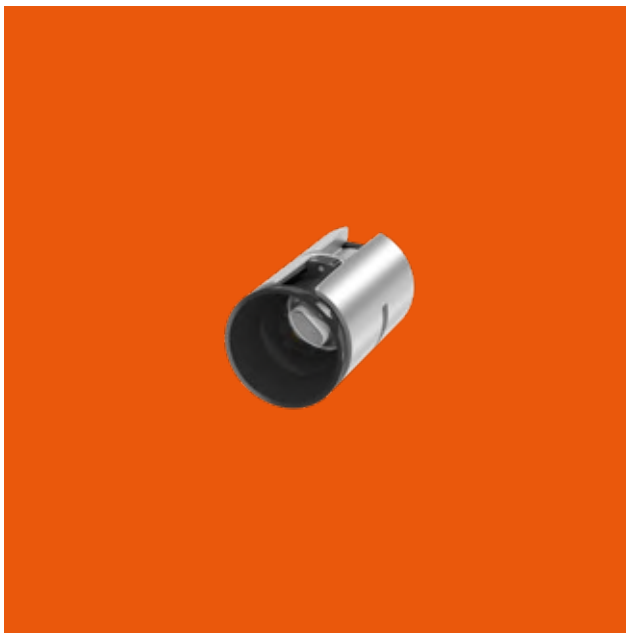

1

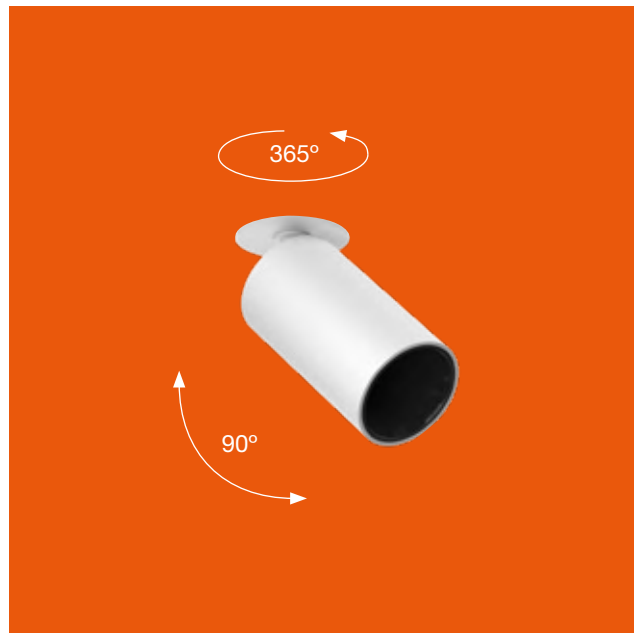

2

LIGHT SHADOW PRO

L'evoluzione naturale di Light Shadow Dots. Le nuove versioni Pro sono il risultato di un'attenta ricerca ottica. Offrono un'efficacia estremamente elevata nonostante le dimensioni ridotte e il corpo compatto.

The natural evolution from the Light Shadow Dots. The new Pro versions are the result of careful optical research. They offer extremely high effectiveness despite their small size and compact body.





Light Shadow Dots è disponibile nelle versioni TRIM e NO TRIM. L'opzione senza cornice permette installare l'apparecchio di illuminazione in un soffitto di gesso, integrandolo perfettamente a filo con il soffitto. È inoltre possibile una disposizione modulare in linea, a due distanze differenti tra un apparecchio e l'altro.

Light Shadow Dots is available in TRIM and NO TRIM versions. The frameless option allows perfect integration into plaster ceilings, resulting in a luminaire that is completely flush and integrated into the ceiling. In addition, it is possible to arrange it in modular in-line presentations, with two options of spacing between the points.



Le precornici No Trim di Light Shadow Dots Fixed e Push sono compatibili e possono essere installate una di seguito all'altra e alla stessa distanza. In questo modo, se i modelli Push vengono installati ad incasso, si differenziano dalle versioni Fixed.

Light Shadow Dots Fixed and Push No Trim pre-installation frames are compatible and can be installed continuously, maintaining the spacing. In this way, when the Push models are in recessed position, they are indistinguishable from the Fixed versions.



Restaurant Het Vliegend
Tapijt, Belgium





Light Shadow Pro sfrutta i benefici di una innovativa lente in silicone che permette un controllo completo del fascio a fronte di un' efficienza elevata, resistenza al calore e massima qualità nella distribuzione luminosa.

Light Shadow Pro exploits the benefits of an innovative silicone lens that allows absolute beam control with an extreme efficiency, heat resistance and maximum quality light distribution.



FLOS TECHNOLOGY

Il parco ottico disponibile comprende 5 aperture di fascio differenziate, ciascuna sviluppata per un'applicazione target speciale. Sia che si tratti di fasci intensivi o effetti di luce diffusa il controllo ottico è sempre eccezionale e la luce spuria è totalmente assente.

The available optical kit includes 5 different beamwidths. Each one of them is developed for a specific application. The optical control is always exceptional and the stray light is totally absent whether for intensive beams or diffuse lighting effects.







Grazie alla soluzione ottica esclusiva brevettata, Light Shadow Pro controlla angoli di cut-off estremi, senza rinunciare all'alta efficienza e un'incredibile versatilità del prodotto.

Thanks to the unique patented optical solution, Light Shadow Pro controls extreme cut-off angles without altering the high efficiency and incredible versatility of the product.

UGR<10

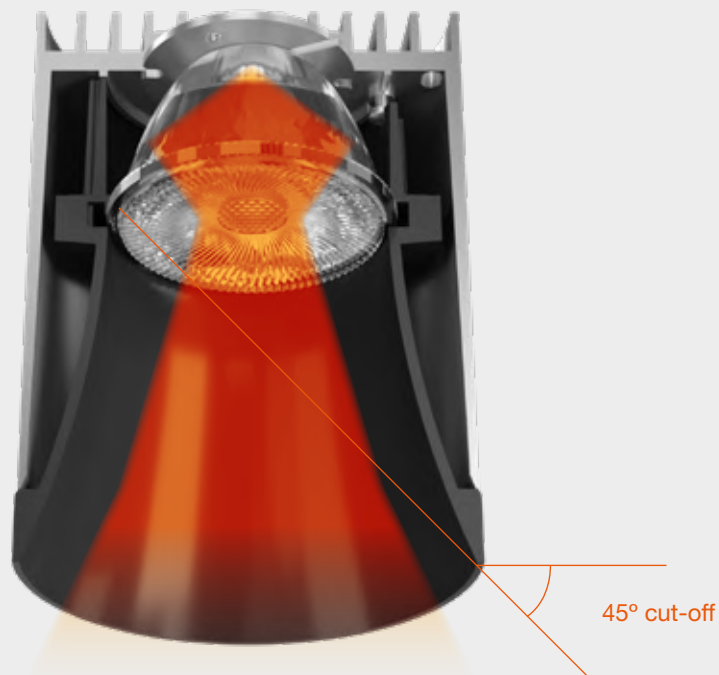

Lente a doppio fuoco sviluppata da FLOS appositamente per questo prodotto. Garantisce massimo controllo ottico e un'eccezionale omogeneità del fascio luminoso.

Dual-focus lens developed by FLOS specifically for this product. It ensures maximum optical control and exceptional light beam homogeneity.

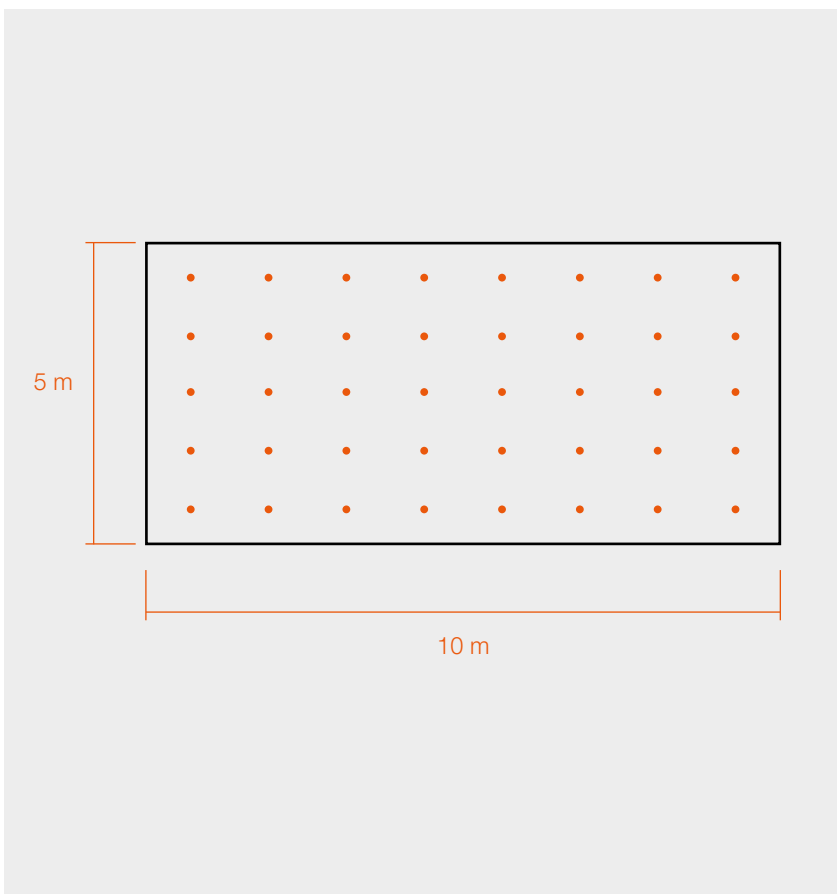

PROGETTO TIPO

Ambiente 5 m x 10 m, h 3 m.

Versione utilizzata: Light Shadow PRO
Flood Optic.

Interdistanza apparecchi: 1,2 m

Parametri illuminotecnici:

UGR < 10 da qualsiasi punto di osservazione (UGR < 19 valore minimo normativo).

Illuminamento medio: 1045 lx

Uniformità ottenuta: 0,68

(0,600 valore minimo normativo).

Norma di riferimento:

UNI-EN 12464-1:2011

PROJECT TYPE

Ambient 5 m x 10 m, h 3 m.

Version used: Light shadow PRO 60
Flood Optic.

Spacing between luminaries: 1.2 m

Technical brightness parameters:

UGR < 10 from any point of observation
(UGR < 19 standard minimum value).

Average brightness: 1045 lx

Uniformity obtained: 0.68

(0.600 standard minimum value).

Reference standard:

UNI-EN 12464-1:2011







	Diverse opzioni di controllo per la regolazione di LIGHT SHADOW DOTS & PRO, tutte disponibili per installazione a incasso o a superficie.	Different control options for dimming LIGHT SHADOW DOTS & PRO, all available for remote recessed or surface installation.
PUSH DIMMING	Controllo mediante un dispositivo di regolazione.	Control through a simple pushbutton.
DALI	Protocollo standard per l'integrazione con qualsiasi sistema di controllo.	Standard protocol for integration with any control system.
1-10V	Controllo remoto in broadcasting (dimmeraggio di tutti gli apparecchi di illuminazione in gruppo).	Broadcasting remote control (dimming of all the luminaires in a single group).
CASAMBI	Controllo broadcast direttamente attraverso un'applicazione per tablet e smartphone (FLOS Control®).	Broadcast control through a tablet or smartphone application (FLOS Control®).



DOTS Ø30
FIXED



POWER LED
UP to 2,7W

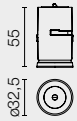

PRO Ø45
FIXED



LED ARRAY
8,5W

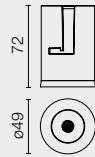

PRO Ø60
FIXED



LED ARRAY
UP to 15W

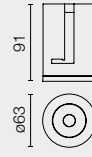

PRO Ø90
FIXED



LED ARRAY
UP to 22W

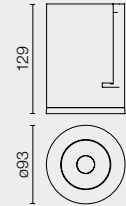

DOTS Ø30
PUSH



POWER LED
UP to 2,7W

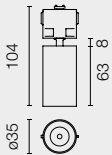

PRO Ø45
PUSH



LED ARRAY
8,5W

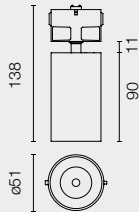

PRO Ø60
ADJUSTABLE



LED ARRAY
10,5W



PRO Ø90
ADJUSTABLE



LED ARRAY
UP to 18W

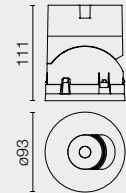

PRO Ø45
SURFACE



LED ARRAY
11W

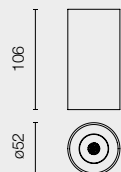

PRO Ø60
SURFACE



LED ARRAY
15W



PRO Ø90
WALL-WASHER



LED ARRAY
18W

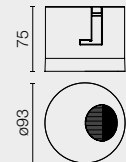

Rear Finish

Light Shadow Pro&Dots Push

- 40 Bianco
40 White
- 14 Nero
14 Black



External Finish

Light Shadow Dots Push / Light Shadow Pro Push & Surface

- 40 Bianco
40 White
- 14 Nero
14 Black
- EQ Rame Spazzolato
EQ Brushed Copper
- ER Acciaio Spazzolato
ER Brushed Steel
- ES Bronzo Spazzolato
ES Brushed Bronze
- TK Teck
TK Teak

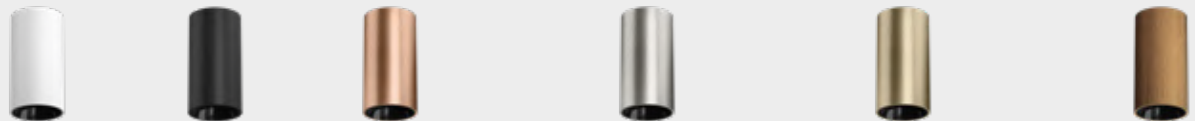

Internal Finish

- 40 Bianco
40 White
- 14 Nero
14 Black
- ER Acciaio
ER Steel
- ES Bronzo
ES Bronze
- EQ Rame
EQ Copper

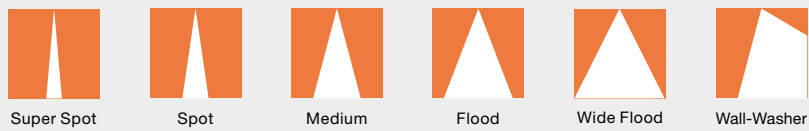

Super Spot Spot Medium Flood Wide Flood Wall-Washer

ECLECTIC

ECLEC

E

TIC

CLEC

ECLECTIC

Lampada da interni ad incasso nel soffitto, la cui concezione modulare segue i principi del disegno e dell'economia circolare. Commercializzata come lampada completa, si scompone in moduli che ne definiscono le caratteristiche e che si vendono anche come pezzi di ricambio.

Recessed in ceiling, indoor luminaire. A product with a modular concept that follows the principles of circular design and economy. Marketed as a complete luminaire, it can be broken down into modules that define its features. These modules are also offered as spare parts.

ECLECTIC

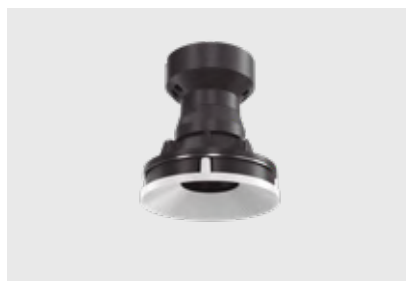
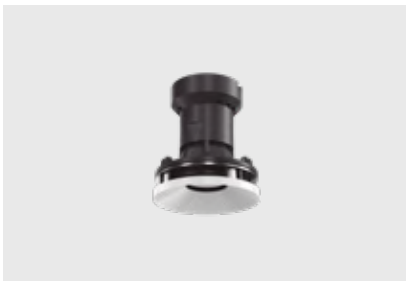

La gamma Eclectic è disponibile in due dimensioni (Ø70 y Ø90) con due modelli ciascuna (fisso e orientabile). Sono disponibili due tipi di quadri d'installazione (Trim e No Trim) e frontali con tre estetiche differenti (Cone Flat y Soft).

The Eclectic range comprises two sizes (Ø70 and Ø90) for which two models are available (fixed and adjustable). Two installation pre-frames (Trim and No Trim) and 3 style modules (Cone Flat and Soft) are available.

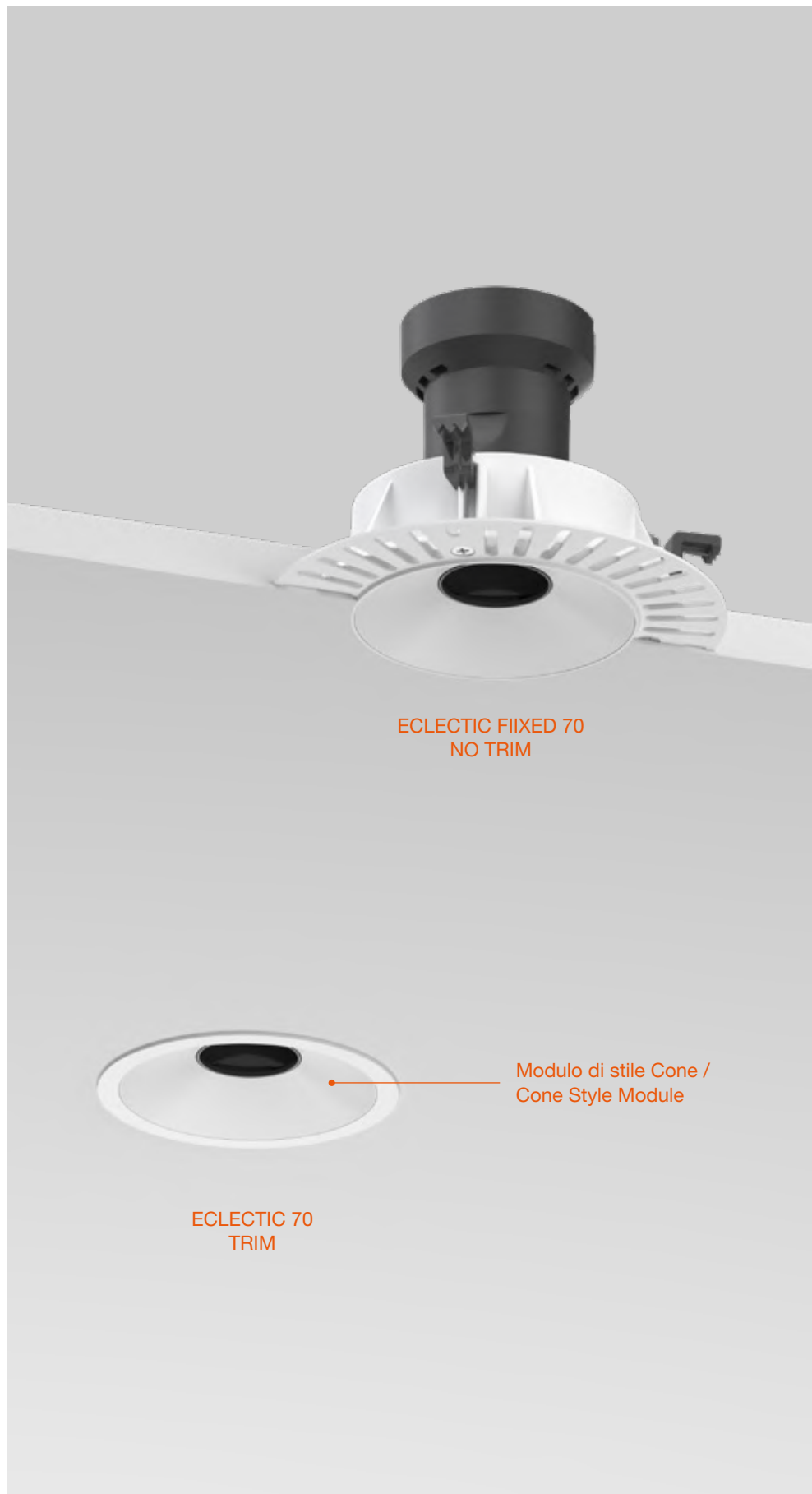



Modulo di stile Flat /
Flat Style Module

ECLECTIC ADJUSTABLE 90
NO TRIM

Modulo di stile Soft /
Soft Style Module

ECLECTIC 90
TRIM







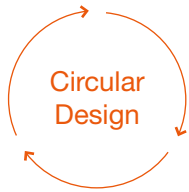

Sei moduli e/o accessori disponibili, commercializzati come articoli indipendenti. Montaggio e sostituzione senza utensili. Versatilità e possibilità di cambi massima, anche dopo l'installazione del prodotto.

There are six modules and/or accessories available, marketed as individual products. Tool-free installation and replacement. Maximum versatility and modification possibilities, even after the product has been installed.



Disegno modulare 'future-proof': a prova di obsolescenza.

Modular "future-proof" design: obsolescence-proof.

1 La configurazione iniziale di Eclectic non rappresenta un limite alle caratteristiche del prodotto, poiché la sua concezione permette di modificarlo e adattarlo. Dall'estetica all'orientazione o all'apertura del fascio luminoso, per rispondere a qualsiasi esigenza ogni parte può essere modificata.
1 The initial configuration of Eclectic does not limit the product in its features thanks to the modification and adaptability possibilities of its design concept. From style to orientation or beam angles, everything can be modified to meet new needs.



1 Qualsiasi parte del prodotto è sostituibile.
1 All product parts are replaceable.

Offerta completa di apertura del fascio luminoso.

Complete range of beam angles.

2. Eclectic offre una gran varietà di aperture, dalla Super Spot alla Wide Flood, per rispondere a qualsiasi necessità dello specificatore del flusso luminoso.
2 Eclectic offers a variety of beam angles ranging from Super Spot to Wide Flood to meet any lighting specifier's needs.

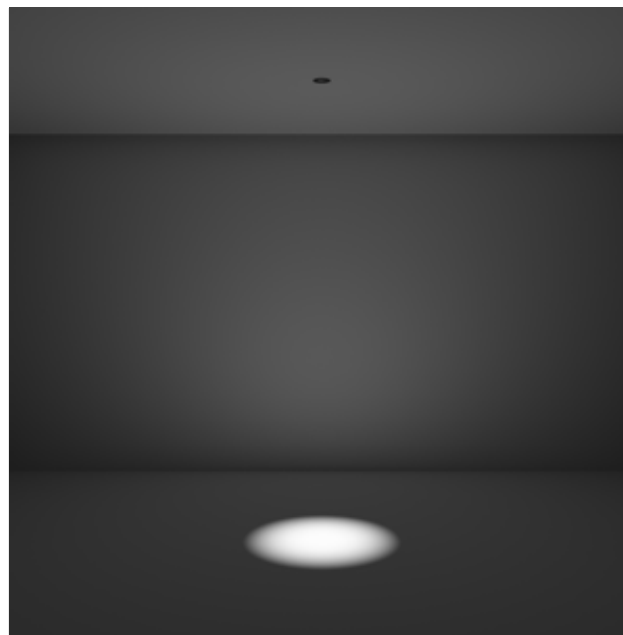

2 Fascio luminoso disponibile in cinque aperture.
2 Five light beam angles available.

Installazione e assemblaggio magnetico.

Magnetic installation and assembly.

3 Eclectic viene fissata al marco di installazione mediante un sistema di unione magnetica di alta qualità che ha superato i più esigenti test di sforzo, carico e tenuta. Questo sistema magnetico, che serve anche per unire i frontali estetici, rende più facile la manipolazione del prodotto nel momento della sua modificazione, sostituzione e attualizzazione.

3 Eclectic attaches to its installation pre-frames thanks to a high quality magnetic attachment system that has been tested and subjected to the most demanding stress, load and durability tests. This magnetic fixing, which is also the way the style façades are attached, facilitates the handling of the product for modification, replacement and upgrading.

Tre estetiche differenti per un solo prodotto.

One product, three different styles.

4 Per rinnovare l'aspetto di Eclectic è sufficiente sostituire il suo modulo estetico con un o differente, da scegliere fra le tre alternative (Cone, Soft y Flat). Inoltre, nella versione No Trim è possibile cambiare anche il tipo di rifiniture dell'apparecchio (dal negro al bianco o viceversa), rimpiazzando l'elemento con uno di ricambio di differente colore.

4 Renewing the appearance of Eclectic is as easy as replacing its style module with a new one, choosing among its three alternatives (Cone, Soft and Flat). In addition, in the No Trim versions, we can even change the finish of the luminaire (from black to white or vice versa), by simply replacing this part with its spare module in a different color.



3 Ancoraggio magnetico per cambi e installazioni agevoli.
3 Magnetically attached for easy changeover and installation.



4 Estetica intercambiabile. Cone, Soft e Flat.
4 Interchangeable style. Cone, Soft & Flat.

Grazie alla soluzione ottica esclusiva brevettata, Eclectic controlla angoli di cut-off estremi, senza rinunciare all'alta efficienza e un'incredibile versatilità del prodotto.

Thanks to the unique patented optical solution, Eclectic controls extreme cut-off angles without altering the high efficiency and incredible versatility of the product.

UGR<10

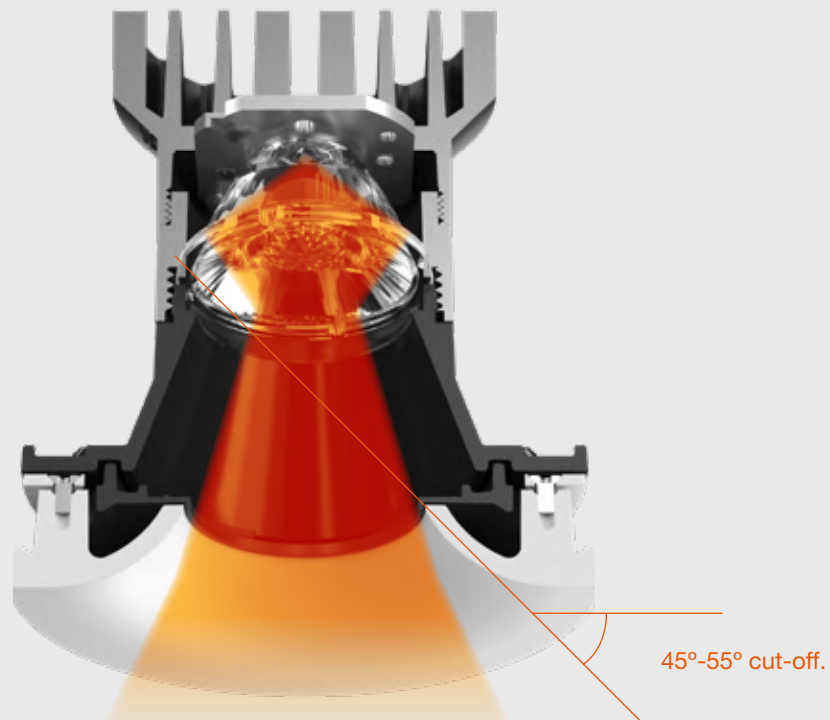

Lente a doppio fuoco sviluppata da FLOS appositamente per questo prodotto. Garantisce massimo controllo ottico e un'eccezionale omogeneità del fascio luminoso.

Dual-focus lens developed by FLOS specifically for this product. It ensures maximum optical control and exceptional light beam homogeneity.

INTENSITÀ E TEMPERATURA DELLA
LUCE, IN UNA DOLCE SINCRONIA

Eclectic dispone di un'opzione di regolazione Dim to Warm, per cui il colore della luce cambia regolando l'intensità. In questo modo, più intenso è il flusso, più fredda risulta la luce; viceversa, più tenue è il flusso, più calda risulta la luce. Versatilità per un'illuminazione morbida e gradevole.”

LIGHT INTENSITY AND TEMPERA-
TURE, SWEETLY SYNCHRONISED

Eclectic has a Dim to Warm dimming option, which links the intensity to the change in the colour of the light. Thus, the higher the flux, the cooler the light and the lower the light, the warmer. Versatility for soft and pleasant lighting.

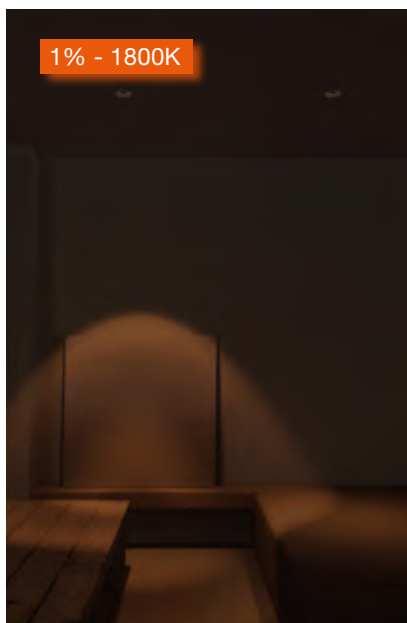

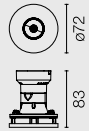
FIXED 70
TRIM / NO TRIMADJUSTABLE 70
TRIM / NO TRIM

LED ARRAY
7,5W

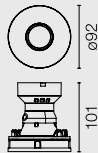
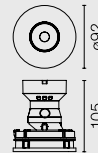
FIXED 90
TRIM / NO TRIMADJUSTABLE 90
TRIM / NO TRIM

LED ARRAY
10,5W

POWER LED
7W

LED ARRAY
DIM TO WARM
13W

La foto in alto rappresenta il montaggio di Eclectic con il modulo di stile Cone, ma è possibile consultare le seguenti opzioni per scegliere lo stile che più si adatta al progetto desiderato.

The product pictures above represent Eclectic equipped with a Cone Style module, but you can refer to the options below to select the style you prefer to match your project.

Cone



□ Bianco
White

■ Nero
Black

Flat



□ Bianco
White

■ Nero
Black

Soft



□ Bianco
White

■ Nero
Black

Capacità di rotazione di 360° e di orientazione di 35° nella versione Ø70 e di 40° in quella Ø90.
Can be rotated 360° and swivelled 35° for Ø70 version and 40° for Ø90 version.

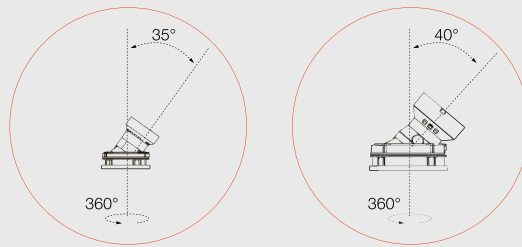

Super Spot



Spot



Medium



Flood



Wide Flood

FLOS
CONTROL BY CASAMBI



LIGHT SHADOW

S P O T

LIGHT SHADOW

S P O T

LIGHT SHADOW

S P O T

LIGHT SHADOW

S P O T

LIGHT SHADOW

S P O T

Il sistema ottico di Light Shadow –composto da lenti bifocali– viene applicato a questa famiglia di faretti per offrire la sua tecnologia –esclusiva e brevettata da Flos– a questo sistema d’illuminazione. Una collezione di faretti in tre dimensioni che vengono installati usando differenti sistemi, dai binari trifase standard alle strutture proprie di Flos (The Tracking Magnet, The Running Magnet e Infra-Structure).

Light Shadow's optical system -with its dual-focus lens- is extended to this family of projectors to offer its exclusive and patented by Flos technology in this lighting fixture. A collection of spotlights in three sizes that are implemented in different systems, from standard three-phase tracks to Flos' own structures (The Tracking Magnet, The Running Magnet and Infra-Structure).

LIGHT SHADOW SPOT







Grazie alla soluzione ottica esclusiva brevettata, Light Shadow Pro controlla angoli di cut-off estremi, senza rinunciare all'alta efficienza e un'incredibile versatilità del prodotto.

Thanks to the unique patented optical solution, Light Shadow Pro controls extreme cut-off angles without altering the high efficiency and incredible versatility of the product.

1 Lente a doppio fuoco sviluppata da FLOS appositamente per questo prodotto. Garantisce massimo controllo ottico e un'eccezionale omogeneità del fascio luminoso.

Dual-focus lens developed by FLOS specifically for this product. It ensures maximum optical control and exceptional light beam homogeneity.

2 I faretto Light Shadow vengono accessoriati con lo schermo nido d'ape anti-abbaglio, combinando la tecnologia di alto comfort visuale di Light Shadow con questo schermo per impedire ancora di più la vista della fonte luminosa.

Light Shadow spots have an anti-glare honeycomb accessory to combine the high visual comfort technology of Light Shadow with this screen to further restrict visual access to the light source.

LIGHT SHADOW SPOT Ø45



1

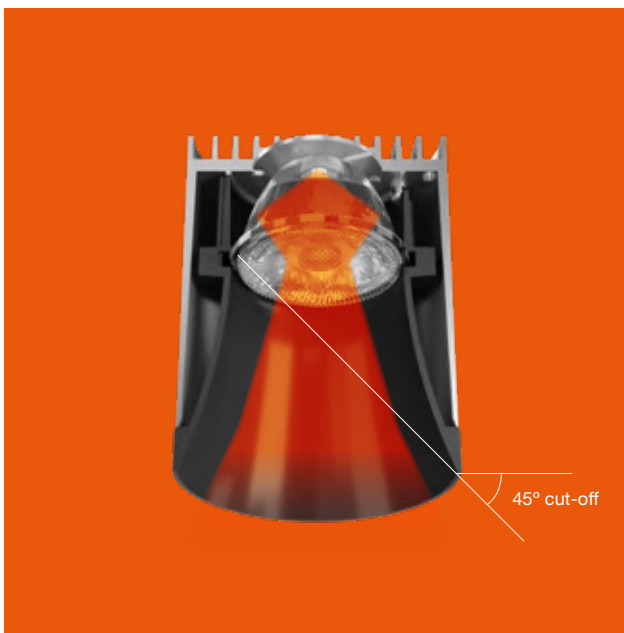

1



2

3 I filtri dicroici CCT permettono di cambiare la temperatura del colore dei faretti Light Shadow, con opzioni di luce calda o fredda che si adattano al tono di luce desiderato.

To obtain the desired light tone, CCT dichroic filters allow the color temperature of the Light Shadow projectors to be varied for cooler or warmer options.

4 Su richiesta, Flos offre delle rifiniture speciali, tanto per il corpo dell'apparecchio d'illuminazione quanto per le parti posteriori e i braccetti posteriori del prodotto.

Available on request, Flos offers special finishes for both the body of the luminaires and for the back and rear arm of the product.

LIGHT SHADOW SPOT Ø60

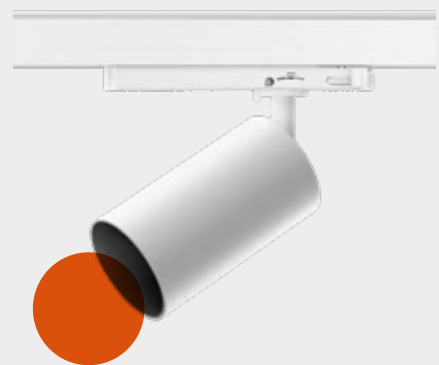

1



3



4

- 1 SUPER SPOT
- 2 SPOT
- 3 MEDIUM
- 4 FLOOD
- 5 WIDE FLOOD

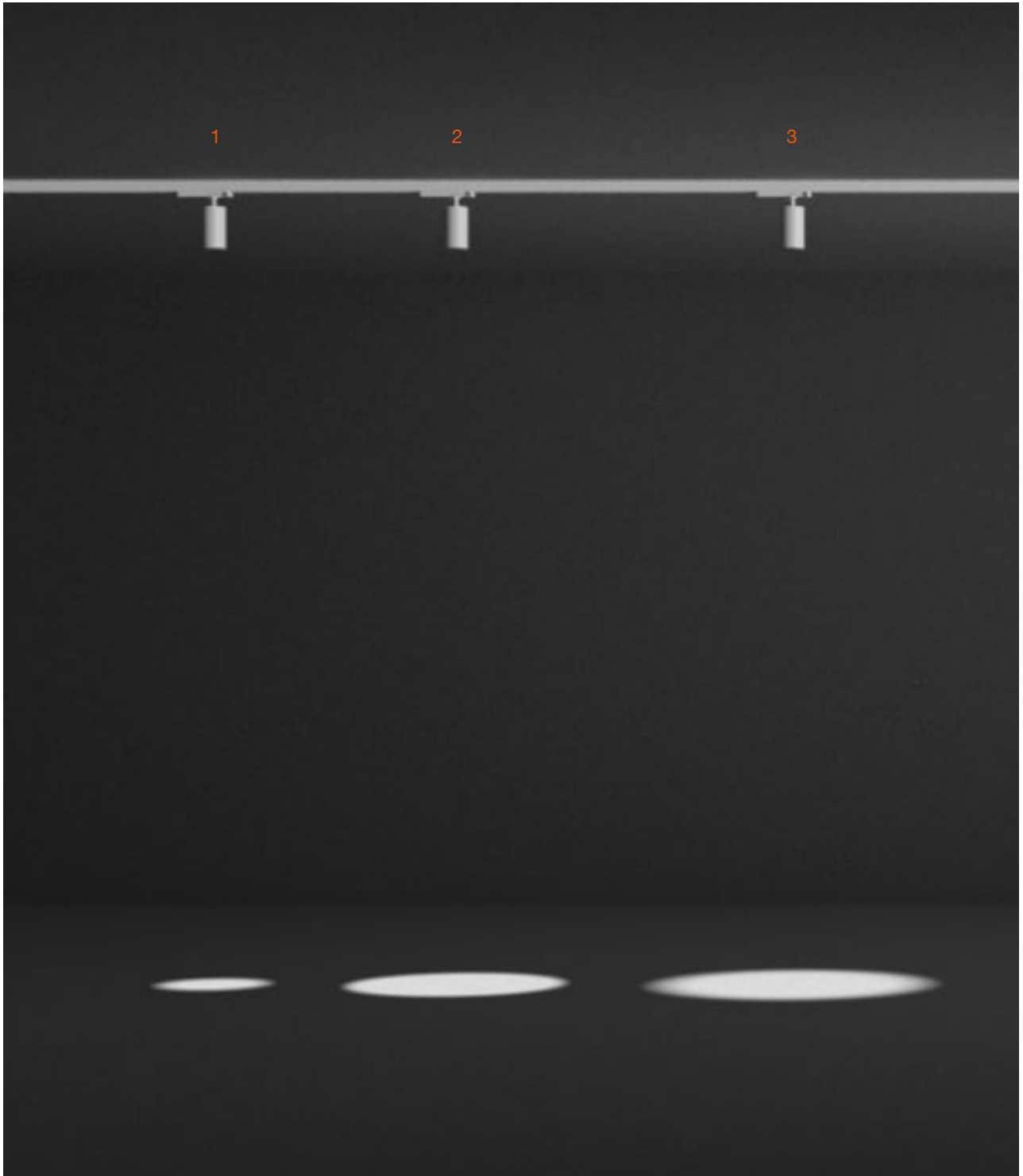

BEAM ANGLES

La collezione di faretti Light Shadow Spot offre tutta una serie di soluzioni ottiche che permettono dei professionisti di scegliere tra tutte le opzioni professionali necessarie a qualsiasi tipo di progetto. Un solo prodotto per più soluzioni, dai fasci di luce Super Spot a quelli Wide Flood.

BEAM ANGLES

The Light Shadow Spots collection offers a range of optics that provide the specifier with all the professional options needed for any project. From Super Spot to Wide Flood apertures, one product with all the solutions.

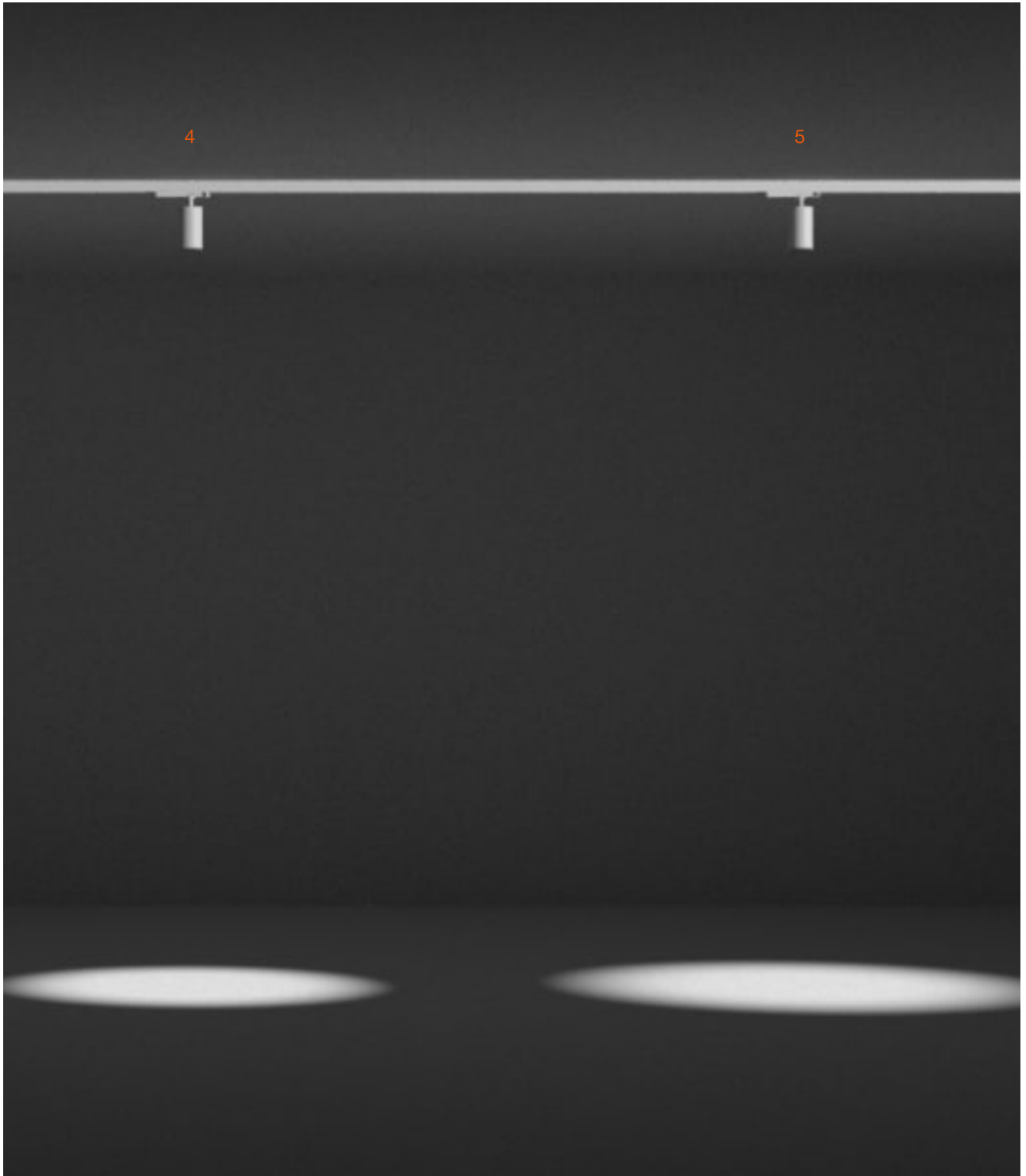







	Diverse opzioni di controllo che possono adattarsi a qualunque necessità.	Different control options that can be adapted to any need.
DALI	Controllo remoto broadcast (dimmerazione di tutti gli apparecchi in un unico gruppo).	Standard protocol for integration with any control system.
CASAMBI	Controllo individuale di ogni apparecchio o controllo remoto broadcast direttamente tramite un'applicazione per tablet o smartphone (FLOS Control®).	Individual control of each luminaire or broadcast remote control directly through a tablet or smartphone application (FLOS Control®).

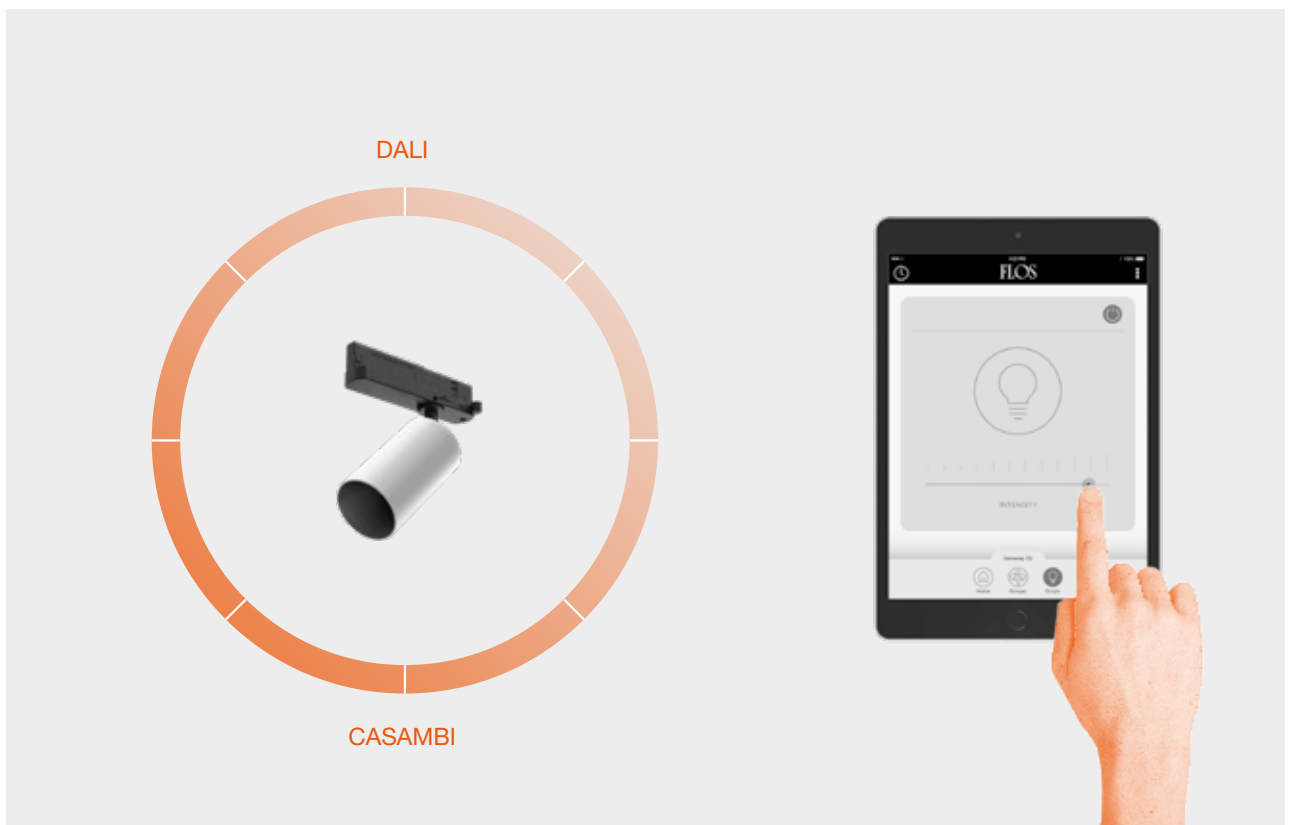

FLOS CONTROL®
BY CASAMBI

L'applicazione FLOS Control® consente di controllare gli apparecchi di illuminazione del sistema in modo individuale o in gruppo, controllando scene e programmazione.

In un impianto elettrico tradizionale, con il gateway connesso via Bluetooth si ottiene un controllo totale dell'ambiente.

Disponibile per iOS e Android

The FLOS Control® application allows you to control the system's luminaires individually or as a group, controlling scenes and programming.

With a traditional electrical installation and the Gateway connected by Bluetooth, you obtain total control of the ambience.

Available for iOS and Android

LIGHT SHADOW SPOT 45



LED ARRAY
11,5W

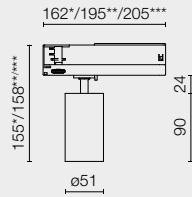

LIGHT SHADOW SPOT 60



LED ARRAY
Up to 22W

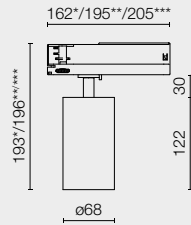

Non Dimming* / Casambi** / Dali***

Compatible with The Tracking Magnet & Infra-Structure.
Compatible with The Tracking Magnet & Infra-Structure.

LIGHT SHADOW
SPOT 30



LIGHT SHADOW
SPOT 45



LIGHT SHADOW
SPOT 60



Compatible with The Running Magnet.
Compatible with The Running Magnet.

LIGHT SHADOW
SPOT 30



LIGHT SHADOW
SPOT 45



□ 40 Bianco
40 White



■ 14 Nero
14 Black



☑ 40.78/YU/C6 All White



■ EQ Rame Spazzolato
EQ Brushed Copper



▨ ER Acciaio Spazzolato
ER Brushed Steel



■ ES Bronzo Spazzolato
ES Brushed Bronze



Super Spot



Spot



Medium



Flood



Wide Flood

FLOS
CONTROL BY CASAMBI



CCCCCC

AAAAAA

MMMMMM

EEEEEE

RRRRRR

AAAAAA

CAMERA

Innovativo programma di proiettori a binario progettato per applicazioni museali e retail. L'esclusivo sistema ottico brevettato è stato declinato in molteplici aperture di fascio realizzate ad hoc con il massimo controllo dell'abbagliamento.

Innovative program of track mounted projectors, designed for museum and retail applications. The unique patented optical system has been applied to multiple purpose-built beamwidths with maximum glare control.

CAMERA





Pilotage Building,
AntwerpPhoto Festival, Belgium



Design essenziale e compatto per un prodotto altamente professionale. Un volume neutro e al tempo stesso immediatamente riconoscibile.

Subtle and compact design for an extremely professional product. Neutral but easily recognizable volume.





CAMERA Ø90

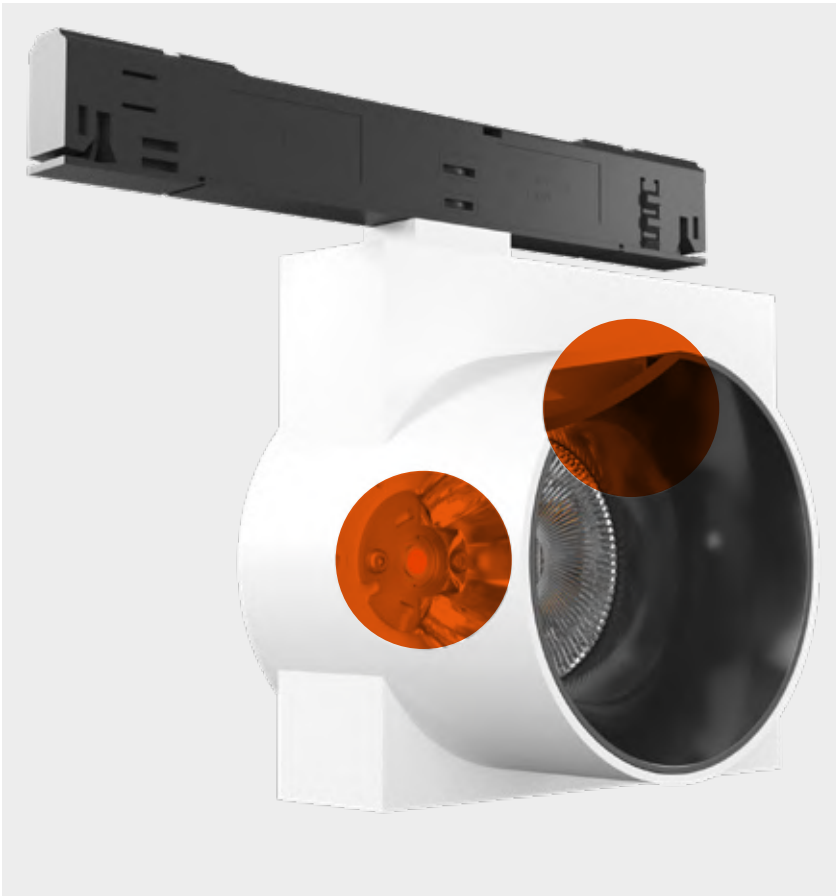

La lente in silicone a doppio fuoco sviluppata da FLOS ha un'ottima resistenza al calore e consente di ottenere fasci precisi ad alta intensità.

The dual-focus silicone lens developed by FLOS features excellent heat resistance and allows precise high-intensity beams.



Regolatore di potenza integrato nel corpo del prodotto disponibile come opzione per il controllo individuale del proiettore.

Power regulator integrated in the product body, available as an option to control the projector individually.





Pilotage Building,
AntwerpPhoto Festival, Belgium



Caratteristiche tecniche altamente professionali e dettagli costruttivi di qualità integrati in un design unico.

Highly professional technical features and quality construction details integrated into a unique design.

1 Camera può essere orientato di 90° sull'asse orizzontale per l'illuminazione zenitale.
Camera can be oriented at 90° on the horizontal axis for zenithal lighting.

2 Lo speciale adattatore estraibile a binario può essere integrato nel prodotto fino a scomparire.
The special, removable rail adapter is integrated into the product until it disappears.

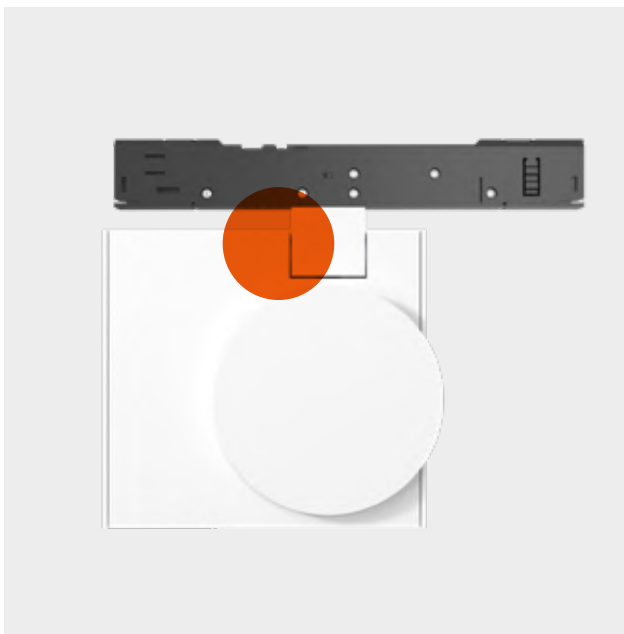

1



2

Ottica esclusiva brevettata.

Exclusive patented optical solution.

4 Parco accessori dedicato disponibile per tutte le versioni del programma.
Dedicated accessory kit available for all versions of the program.

3 Camera controlla angoli di cut-off estremi, senza rinunciare all'alta efficienza (97%) e un'incredibile versatilità del prodotto.
Camera controls extreme cut-off angles while maintaining its high efficiency (97%) and unparalleled product versatility.



Il parco ottico disponibile comprende 5 aperture di fascio differenziate, ciascuna sviluppata per un'applicazione target speciale. Sia che si tratti di fasci intensivi o effetti di luce diffusa il controllo ottico è sempre eccezionale e la luce spuria è totalmente assente.

The optical kit available includes 5 different beamwidths. Each one of them is developed for a specific application. The optical control is always exceptional and the stray light is totally absent whether for intensive beams or diffuse lighting effects.

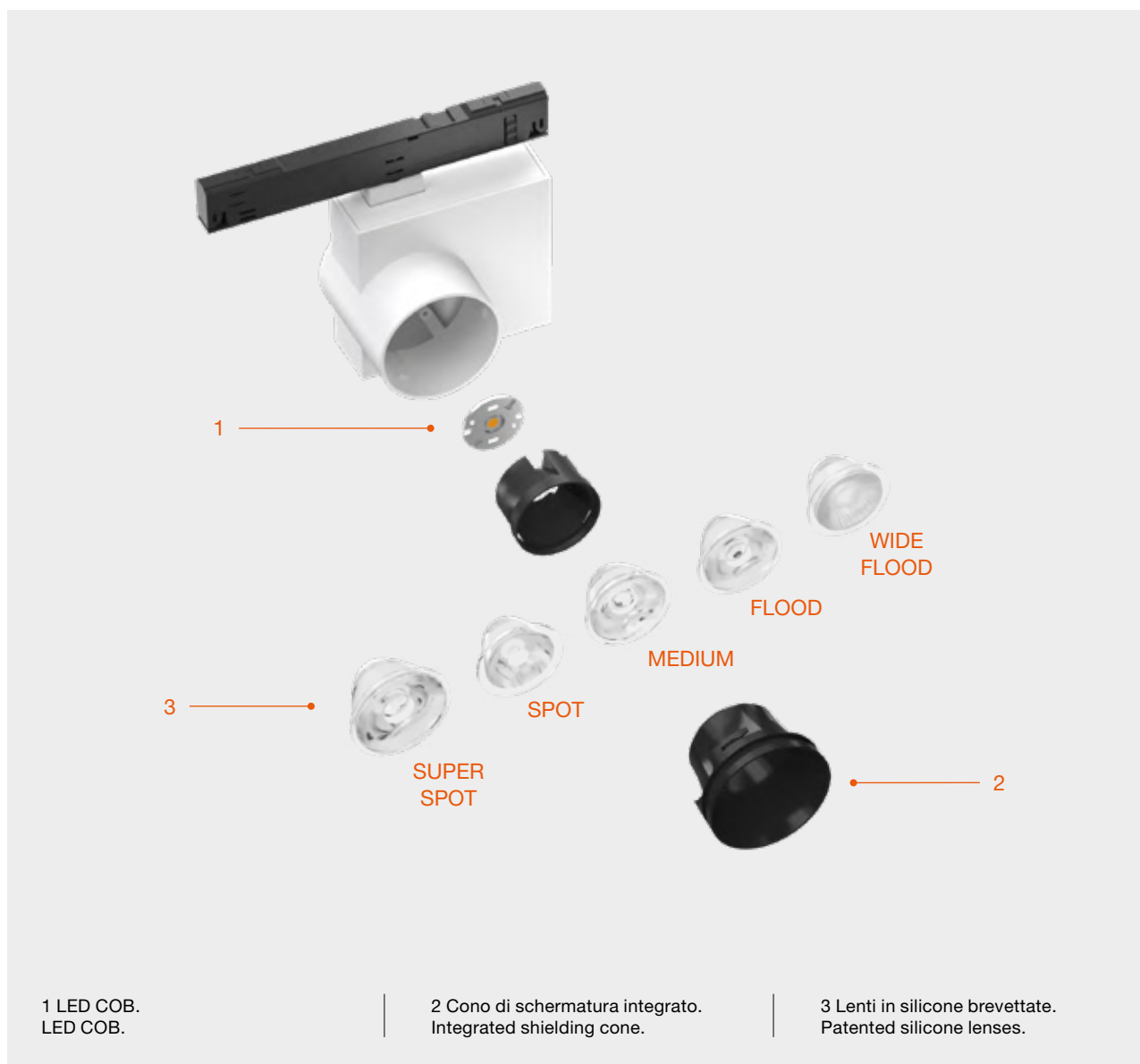

Il gruppo ottico full cut-off garantisce il massimo controllo visivo e genera un'eccezionale omogeneità del fascio luminoso.

The full cut-off optical unit guarantees maximum visual control and generates an unparalleled homogeneity in the light beam.

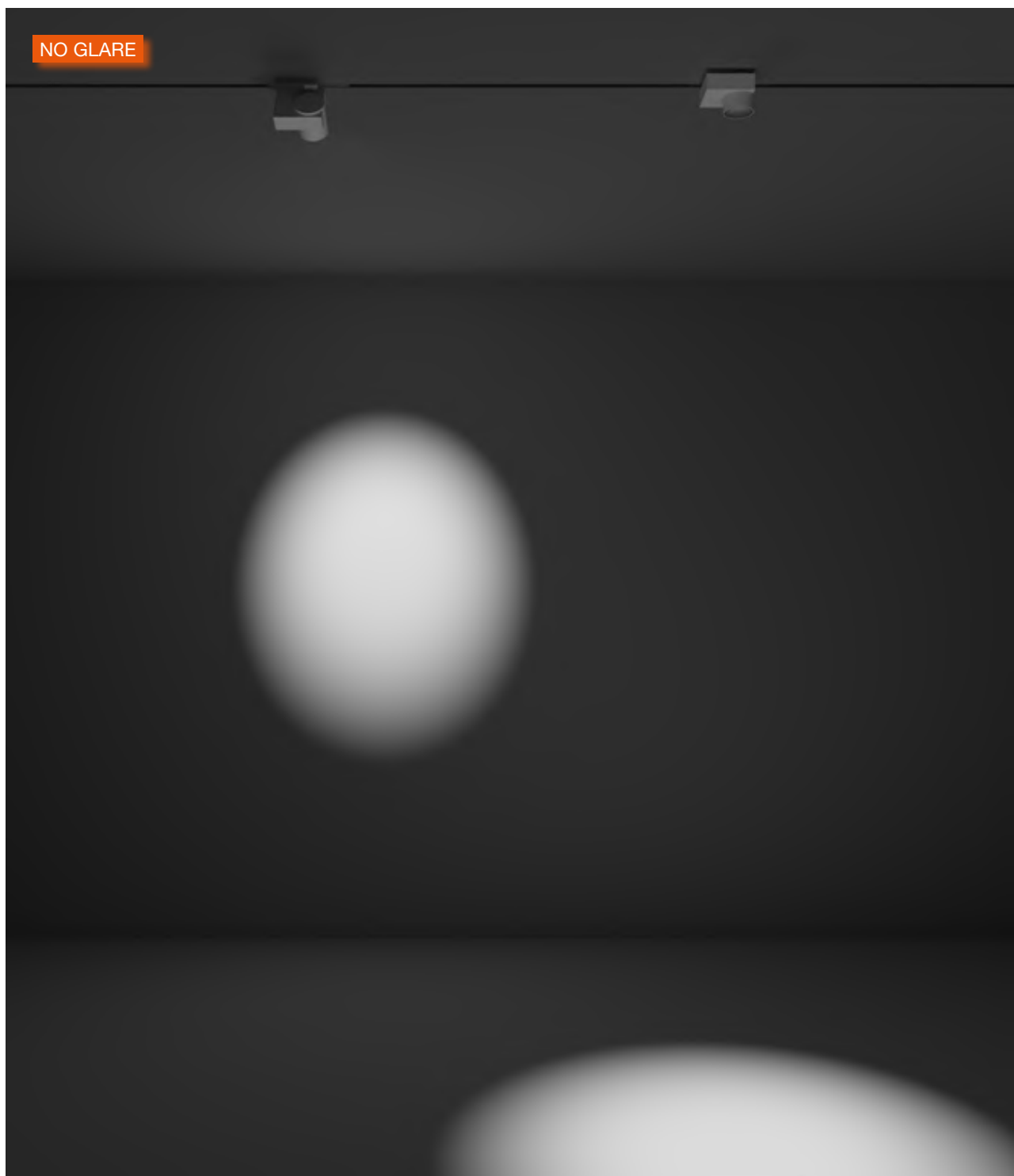



CAMERA Ø60



LED ARRAY
UP to 20W

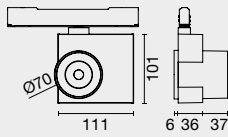

CAMERA Ø90



LED ARRAY
UP to 32W

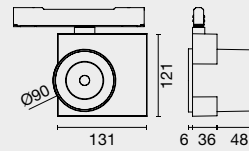

Compatible con The Tracking Power.
Compatible with The Tracking Power.

□ 40 Bianco
40 White

■ 14 Nero
14 Black

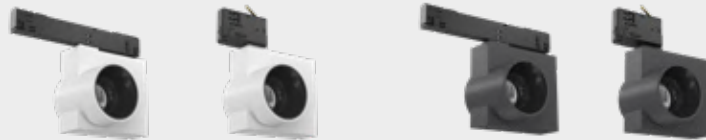

Super Spot



Spot



Medium



Flood



Wide Flood

FLOS
CONTROL BY CASAMBI



SUPER

& PRO LINE & PRO

LINE & PRO LINE

SUPER

& PRO LINE & PRO

LINE & PRO LINE

SUPER

Apparecchio di illuminazione di alto livello tecnologico, efficiente e delicato, formato da un'asta che combina illuminazione diretta e indiretta, sostenuta da due cavi coassiali che forniscono sostegno e cablaggio elettrico. Perfetto per uffici o spazi che richiedono una gran efficienza luminosa ed un elevato comfort.

Efficient and delicate luminaire featuring a high technological level. It is composed of a bar combining direct and indirect light and held by two coaxial cables that provide support and electrical wiring. Perfect for offices or places that require high lighting efficiency and comfort.

SUPER LINE & PRO







Super Line è dotato di un filtro diffusore tecnico multistrato che assicura una distribuzione perfetta della luce e migliora l'effetto ottico e il comfort visivo. Super Line Pro monta un raster nero, che garantisce un controllo totale della distribuzione della luce e il massimo comfort in ambienti di lavoro.

Super Line is equipped with a technical multi-layer diffuser filter that guarantees perfect light distribution and improves the optical effect and visual comfort. Super Line Pro is fitted with a black raster that ensures total control of the light distribution and maximum comfort in work environments.

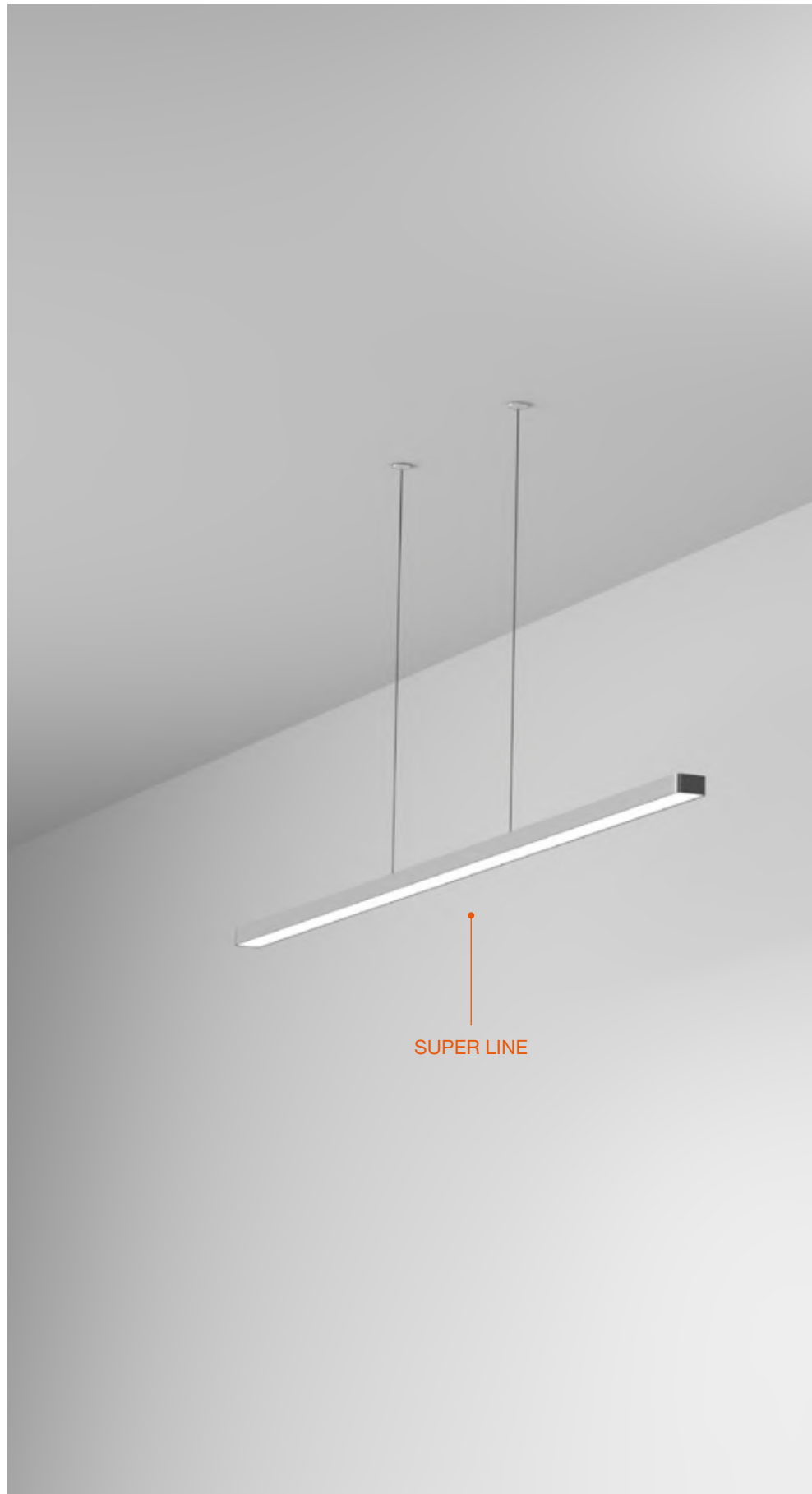



SUPER LINE PRO



Il gruppo ottico che caratterizza Super Line Pro è brevettato ed è composto da un raster ottico modulare a celle quadrangolari abbinato ad una lente primaria.

The patented optical unit that characterizes Super Line Pro consists of a modular optical raster with four-sided cells combined with a primary lens.



Alimentazione tramite cavo coassiale.

Powered by a coaxial cable.

1 L'installazione a soffitto avviene tramite un sistema di aggancio rapido ad incasso brevettato che consente di regolare la lunghezza dei cavi in fase di montaggio. The ceiling installation is carried out by means of a patented recessing system for quick adjustment that allows you to adjust the cables length during the installation.

2 L'uscita cavi nell'apparecchio è individuale per il controllo dell'emissione diretta e indiretta ed è contrassegnata da un elemento stampato dedicato che riporta le scritte "Up Light" e "Down Light". The device's cable outlet is individual for direct and indirect emission control, and is marked by a specific printed element showing the words "Up Light" and "Down Light".

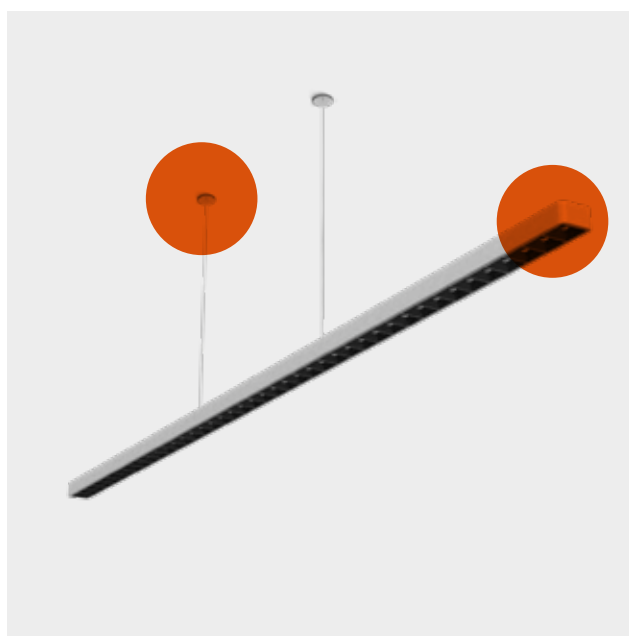

1



2



Ottica esclusiva brevettata.

Exclusive patented optical solution.

3 La lente primaria è realizzata in PMMA con una texturizzazione superficiale dedicata e finitura Frosted al fine di garantire la massima omogeneità dell'effetto luminoso. The main lens is made of PMMA. It features a dedicated surface texturing and Frosted finish to guarantee the maximum homogeneity of the lighting effect.

4 Il profilo superiore dell'apparecchio è stato sviluppato in combinazione con la lente per evitare che la luce indiretta lo colpisca causando sgradevoli fenomeni di abbagliamento alla vista.

The upper profile of the luminaire has been developed in combination with the lens to prevent indirect light from hitting it, which would cause an unpleasant glare to the eye.

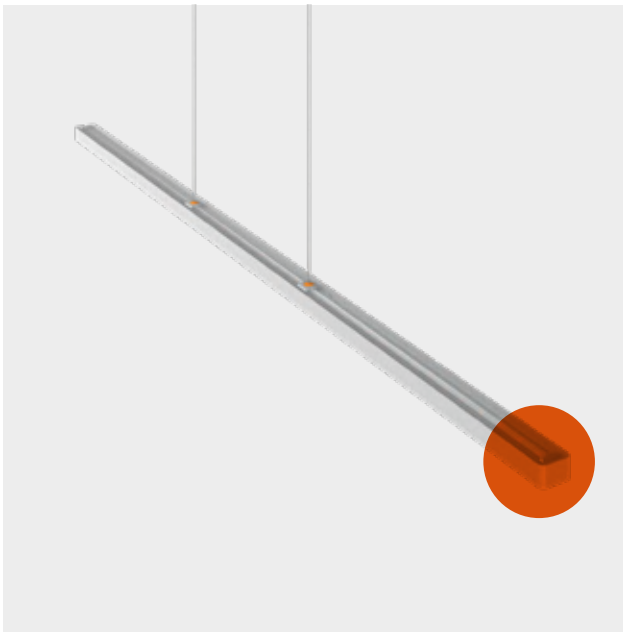

3

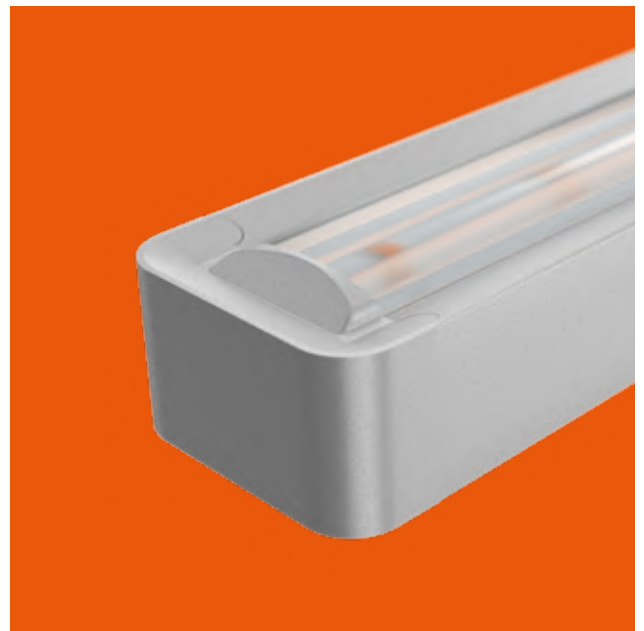

4

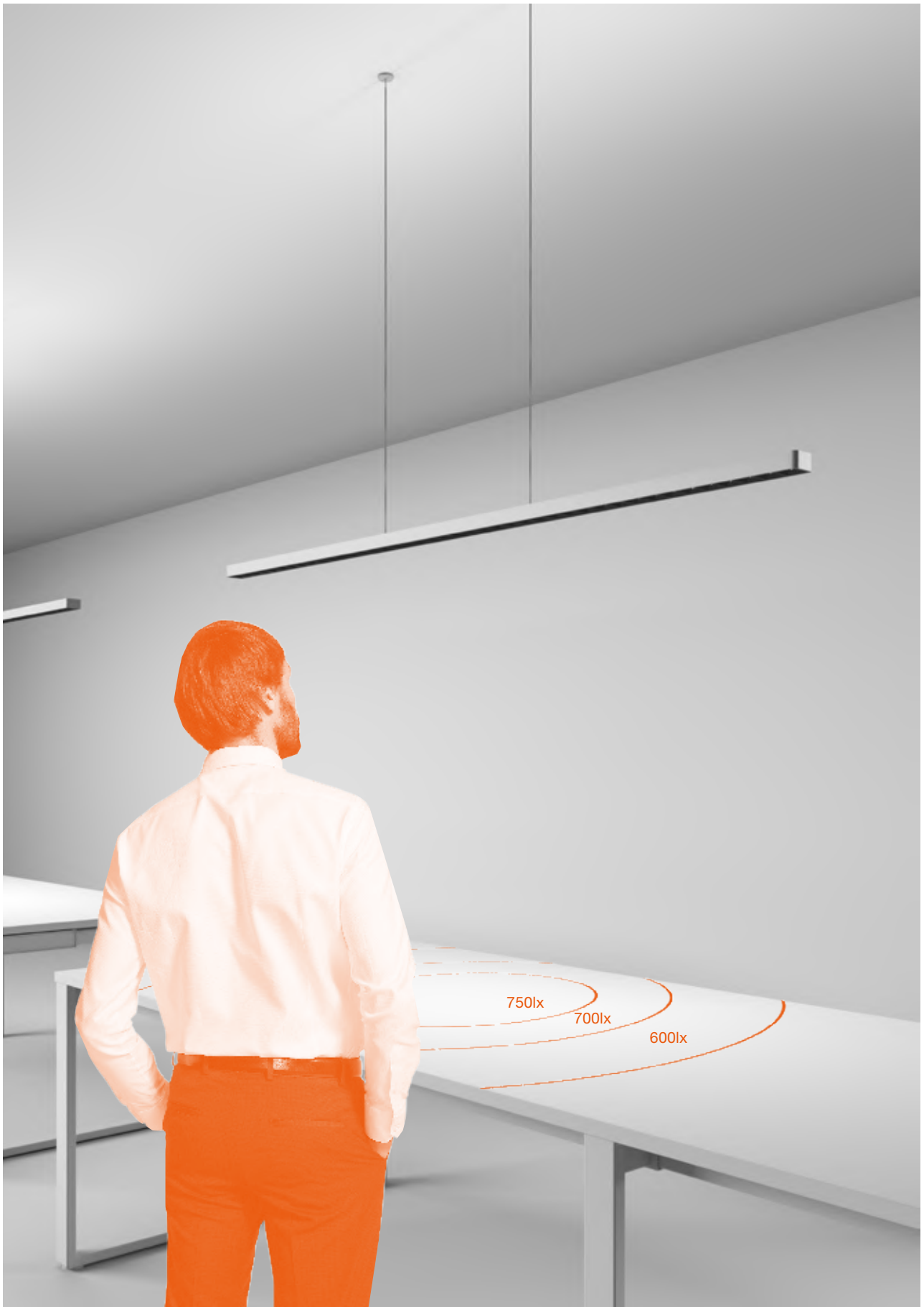

La sorgente luminosa utilizzata per la gestione dell'emissione diretta è particolarmente arretrata all'interno del profilo per sfruttare il massimo controllo dell'abbagliamento diretto. Il gruppo ottico brevettato è stato sviluppato specificatamente per applicazioni in ambienti Office.

The light source used for managing the direct emission is positioned far back inside the profile in order to seize the maximum control of the direct glare. The patented optical unit was specifically developed for applications in Office environments.

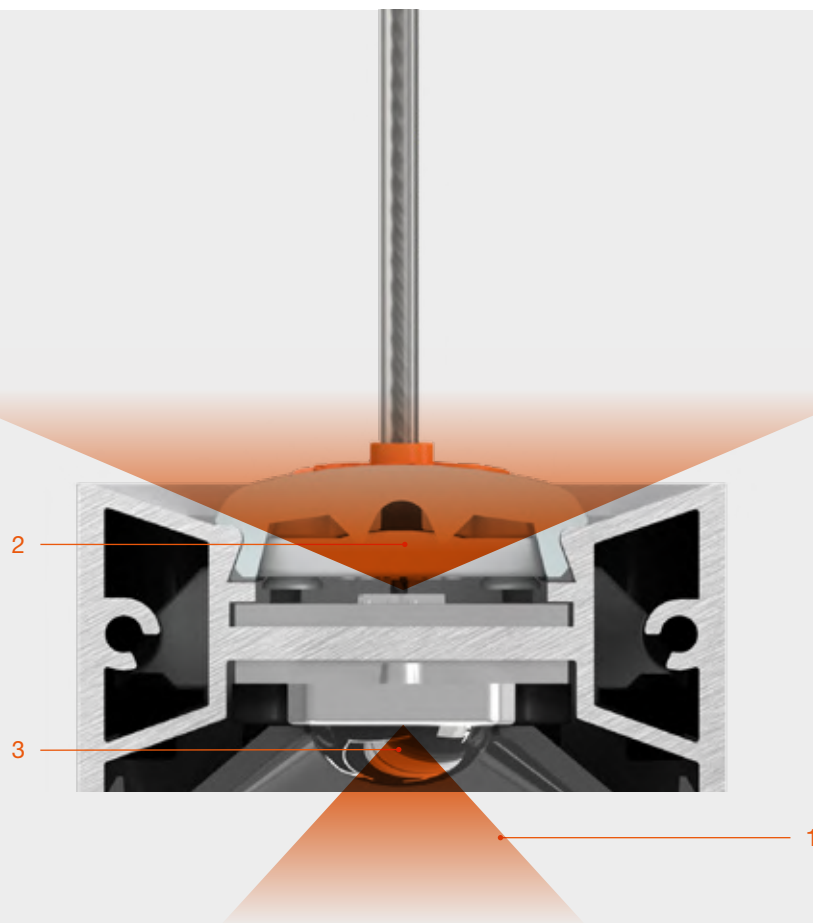

1 Angolo di schermatura estremo senza rinunciare alle dimensioni ultracompatte e a valori di efficienza elevati.
Extreme shielding angle that does not compromise the ultra-compact dimensions and high efficiency values.

2 Scheda LED integrata.
Integrated LED PCB.

3 Lente primaria texturizzata.
Textured primary lens.





Elemento ornamentale per l'installazione con apparecchio remoto.

Embellishment for installation with remote equipment.

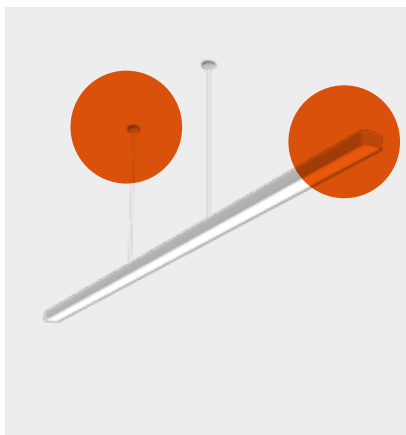

Lo speciale diffusore opale che completa l'apparecchio caratterizzando l'emissione diretta assicura la massima uniformità e una distribuzione pressochè lambertiana.

The special opal diffuser that completes the luminaire, characterizing the direct emission, ensures maximum uniformity and a practically Lambertian distribution.

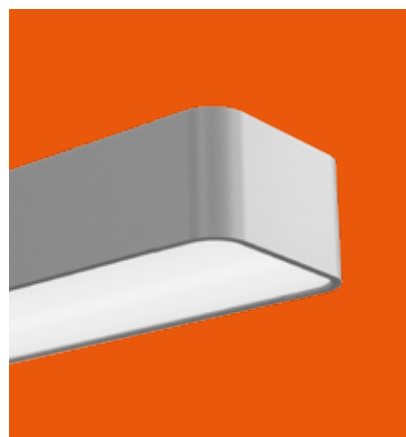

Nonostante le sue dimensioni supercompatte e la vicinanza dei punti LED al diffusore, la luce è distribuita in modo omogeneo. Non si vedono i punti LED.

Although its dimensions are extra compact and the LED tips are close to the diffuser, it offers homogeneous light distribution. The LED tips are not visible.

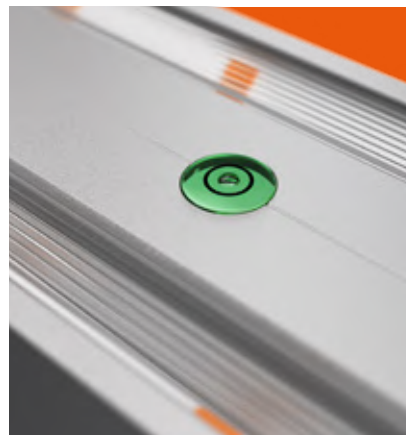
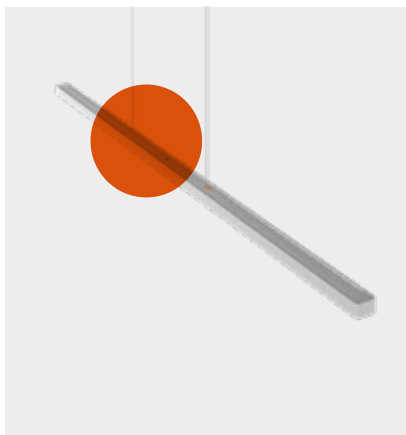

Dettaglio del cavo coassiale che crea la connessione elettrica e serve allo stesso tempo da sospensione.

Detail of the coaxial cable that forms the electrical connection and can also be used for suspending.





SUPER LINE
UP&DOWN
INDIRECT



TOP LED
58W

SUPER LINE
UP&DOWN
DIRECT



TOP LED
58W

SUPER LINE
DOWN



TOP LED
38,6W

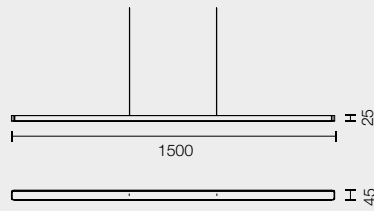

40 Bianco
40 White

02 Grigio
02 Grey

14 Nero
14 Black

ET Ottone Spazzolato
ET Brushed Brass

EU Oro rosa Spazzolato
EU Brushed Rose Gold

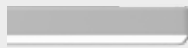
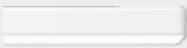

Flood
Up&Down



Flood

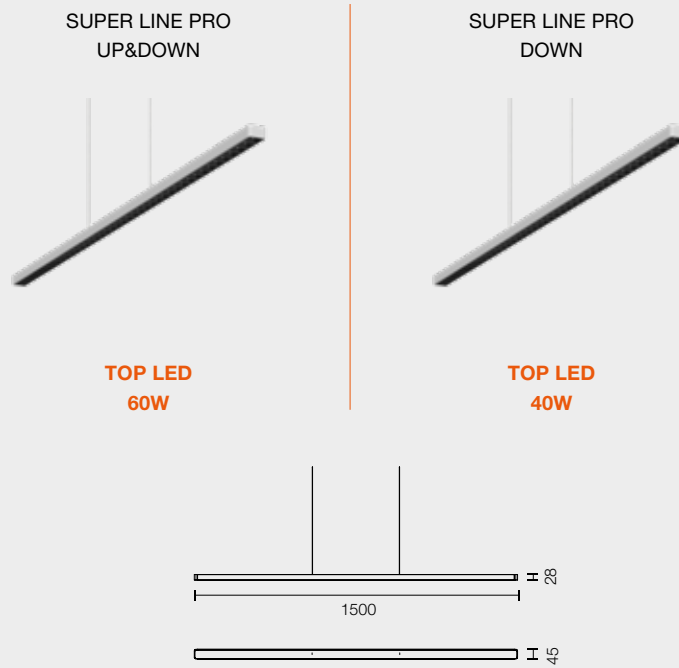

□ 40 Bianco
40 White

■ 02 Grigio
02 Grey

■ 14 Nero
14 Black

■ ET Ottone Spazzolato
ET Brushed Brass

■ EU Oro rosa Spazzolato
EU Brushed Rose Gold

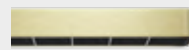
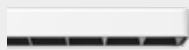

Flood
Up&Down



Flood

FLOS
CONTROL BY CASAMBI



KAP

KAP

KAP

KAP

KAP

KAP

KAP

KAP

KAP

KAP

KAP

Collezione di elementi ad incasso per impianti indoor, che comprende soluzioni sia con LED di ultima generazione, che con apparecchi d'illuminazione con fonte di luce tradizionale. Ampia varietà di dimensioni e finiture, per una perfetta integrazione in tutti gli ambienti. Corpo ottico disegnato per garantire un elevato comfort visivo.

A collection of recessed elements for interior installations that include avant-garde LED solutions and luminaires with a traditional light source. A wide variety of sizes and finishes that ensure a perfect integration in all environments. Optic body to ensure an excellent visual comfort.

KAP





Private House, Geneva



Un programma completo e versatile, capace di risolvere innumerevoli esigenze di progetto grazie all'incredibile varietà di dimensioni, potenze, finiture ed accessori disponibili.

A complete and versatile program capable of meeting innumerable project needs thanks to the incredible variety of sizes, powers, finishes and accessories available.



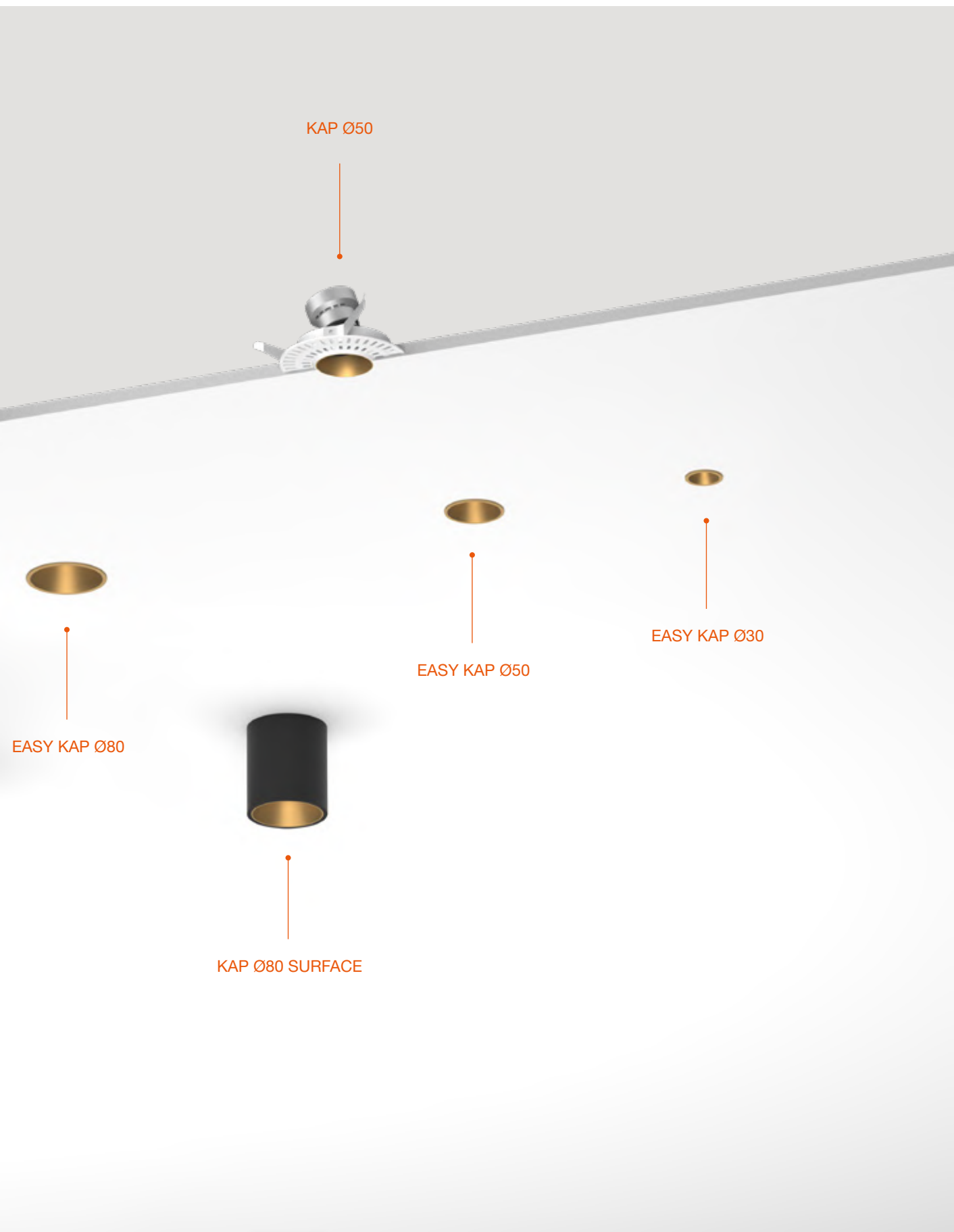





KAP

Forma e funzione combinati in un apparecchio tecnico capace di fondersi totalmente con l'architettura grazie al dettaglio del gruppo ottico senza bordi a vista.

Form and function are combined in a technical device that completely merges with the architecture thanks to the details of the optical unit with no visible edges.

1 L'apparecchio include nel corpo principale un radiatore per il controllo della temperatura.
The main body of the luminaire contains a radiator for temperature control.

2 Il corpo comprende un diffusore realizzato in materiale termoplastico che favorisce una perfetta distribuzione della luce nei piani orizzontali.
The housing includes a thermoplastic diffuser which ensures a perfect light distribution on horizontal surfaces.

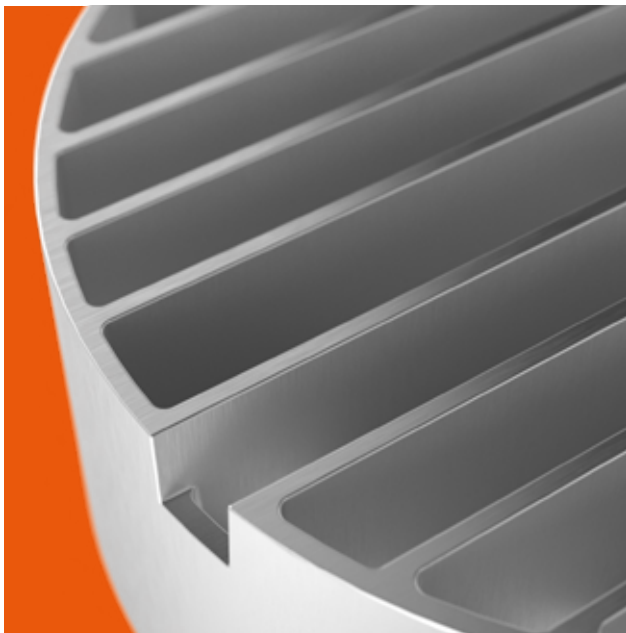

1



2

EASY KAP

Le performance e le finiture di Kap, declinate in un modello piú versatile e maneggevole che aumenta la semplicità d'installazione grazie al gruppo ottico con bordo a vista.

The performance and finishes of Kap are applied to a more versatile and manageable model that increases the simplicity of installation thanks to the optical unit with a visible edge.

3 Dissipatore ad alte prestazioni in alluminio pressofuso.
High performance sink in die-cast aluminum.

4 Un sottile bordo in aggetto aiuta a nascondere eventuali imperfezioni nel soffitto e garantisce un'installazione impeccabile.

A thin, protruding edge helps hiding any imperfections in the ceiling and guarantees a flawless installation.











KAP dim to warm rappresenta l'avanguardia nel controllo della temperatura colore. L'esclusiva tecnologia dim to warm copre un range che va da 2850K a 1800K con un'ottima resa cromatica attraverso un impeccabile controllo sincronizzato di intensità luminosa e temperatura di colore. Il sistema simula la dimmerazione delle tradizionali lampade incandescenti sfruttando il meglio della tecnologia LED attuale.

KAP dim to warm represents the state of the art in color temperature control. The unique dim to warm technology covers a range from 2850K to 1800K with optimal color performance thanks to a flawless synchronized control of light intensity and color temperature. The system simulates the regulation of traditional incandescent lamps exploiting the best current LED technology.

1800K  2850K





EASY KAP 30 FIXED

La misura 30 di Easy Kap rappresenta il modello più piccolo di tutta la famiglia KAP. Un punto luce piccolo, elegante e discreto da soffitto, per un'illuminazione generale o d'accento con una presenza minima nello spazio.

The Easy Kap 30 is the smallest model in the KAP product family. This is a small, sleek, understated ceiling light for general or focused lighting, taking up minimum space.

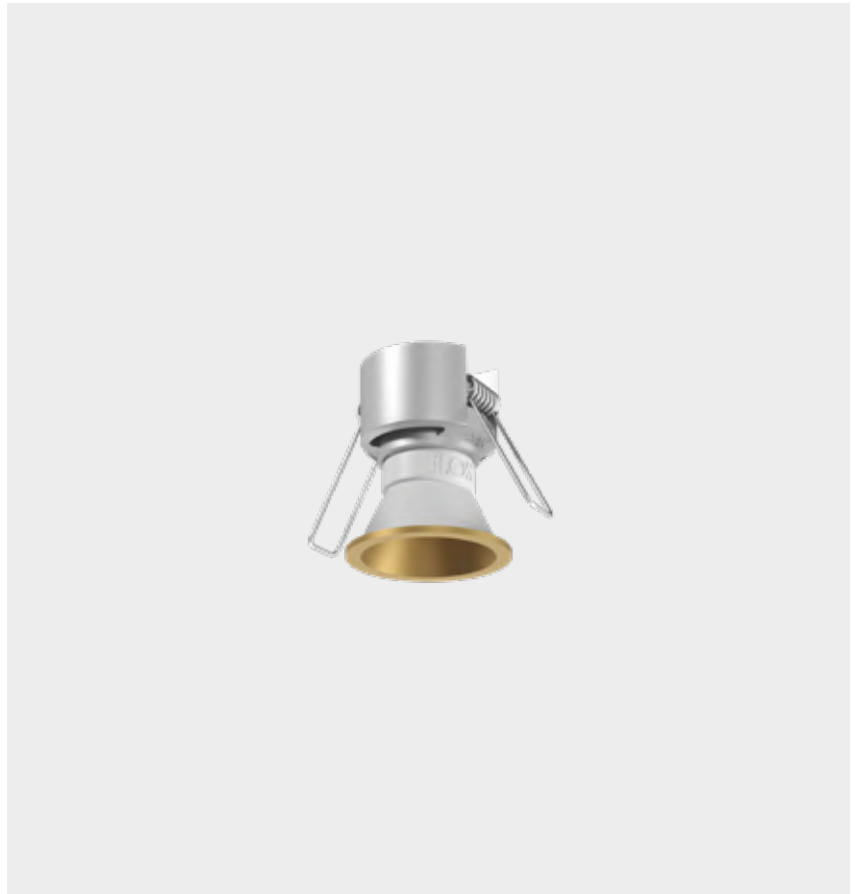

EASY KAP 30 ADJUSTABLE

La variante orientabile di Easy Kap 30 permette di regolare leggermente il fascio di luce di 17° su entrambi gli assi. Una lieve direzionalità che permette a questo modello di fare la differenza nell'illuminazione di un progetto.

With the adjustable Easy Kap 30 model the light beam can be slightly adjusted by an angle of 17° on both axes. The slight directionality featured in this model brings distinctive detail to the design of the light.

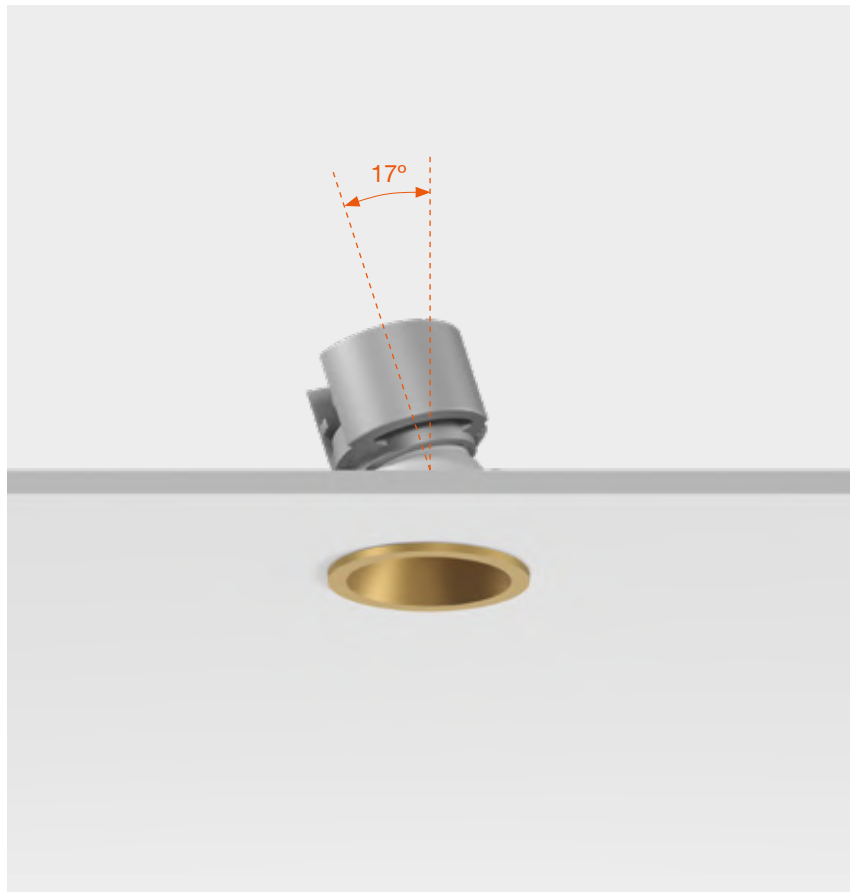







KAP 50

Kap 50 completa l'offerta in gamma con una soluzione compatta e performante che grazie alle tecnologie LED di nuova generazione assicura prestazioni di rispetto nonostante le sue dimensioni ridotte.

Kap 50 completes the range with a compact, high-performance solution that, thanks to new-generation LED technologies, guarantees optimal performance despite its small dimensions.



KAP 50 ADJUSTABLE

Dimensioni compatte e grande flessibilità grazie alle mini versioni orientabili, ideali per applicazioni domestiche e alberghiere.

Compact dimensions and great flexibility thanks to the mini adjustable versions, perfect for home and hotel applications.





Hotel Brooklyn, New York

Per l'installazione individuale delle versioni da incasso di KAP sono necessari degli accessori (precornice), disponibili nella versione Trim e No Trim (consultare in base al modello). L'installazione ad incasso è possibile solo in soffitti di cartongesso (gesso).

The recessed versions of KAP require individual installation accessories (pre-installation frames) available in Trim and No Trim versions (depending on the models, please consult). This recessed installation method is valid only for plasterboard ceilings.

Disponibile box per installazione sul soffitto in cemento.

Available can for the installation in cement ceilings.



KAP SQUARE

La purezza del quadrato è disponibile in alternativa alla classica versione con riflettore circolare per tutte le soluzioni in gamma.

For all the solutions in the range, the purity of the square is available as an alternative to the classic version with a circular spotlight.

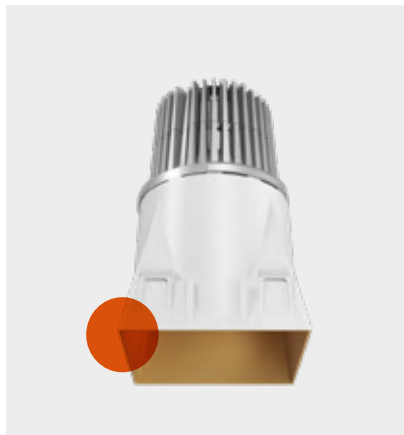

KAP ADJUSTABLE

Corpo orientabile con meccanismo di blocco del puntamento integrato. Ideale in abbinamento a ottiche intensive per regie di luce flessibili e ad alto contrasto.

Rotary body with integrated focal points locking mechanism. Perfect combined with intensive optics for flexible, high-contrast lighting controls.

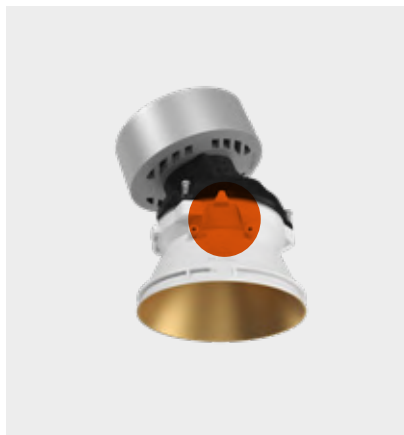

KAP DEEP

Ottica a doppio fuoco ideale per la gestione di ambienti con doppi volumi o altezze elevate.

Dual-focus optics, ideal for managing environments with double volumes or high heights.

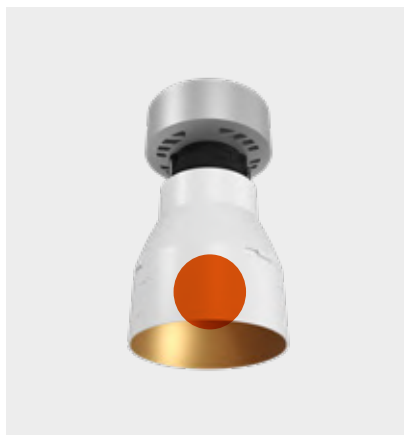

KAP WALL-WASHER

Ottica asimmetrica per l'illuminazione uniforme di piani verticali. Dona all'ambiente profondità e maggiore luminosità percepita.

Asymmetric optic for uniform lighting of vertical surfaces. Provides depth and greater perceived brightness to the room.





Arclinea Headquarters,
Italy



United Nations,
Geneva



Con lo stesso design di Kap 80, Kap 80 Plus si distingue grazie all'esclusivo dissipatore dedicato che incrementa la performance del prodotto mantenendo inalterata la qualità dell'effetto luminoso.

With the same design as Kap 80, Kap 80 Plus stands out thanks to the exclusive dedicated sink, which improves the product's performance without altering the quality of the lighting effect.

Tutti gli Easy Kap 80 LED hanno incluso un diffusore opale che si può montare per aumentare il comfort visivo e la schermatura dell'apparecchio di illuminazione.

All the Easy Kap 80 LED have an opaline diffuser that can be assembled to increase visual comfort and screening of the luminaire.

Effetto No Trim grazie ad un nuovo sistema di montaggio. Il montaggio a baionetta consente la sostituzione della lampada senza necessità di utilizzare utensili.

Total No Trim effect achieved due to a new installation system. The bayonet-based assembly allows to replace the lamp without using any particular tools.

Nell'apparecchio è incorporato un diffusore realizzato in materiale termoplastico per ottenere una perfetta distribuzione della luce sui piani orizzontali.

The luminaire includes a thermo-plastic diffuser which ensures a perfect light distribution on horizontal surfaces.

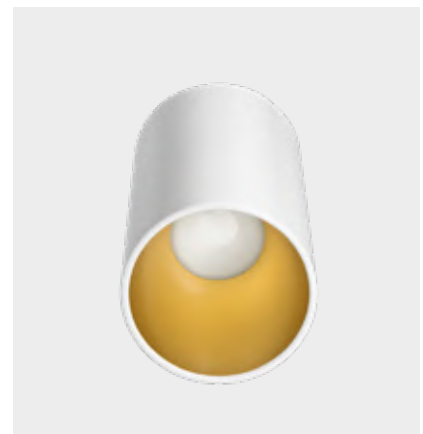

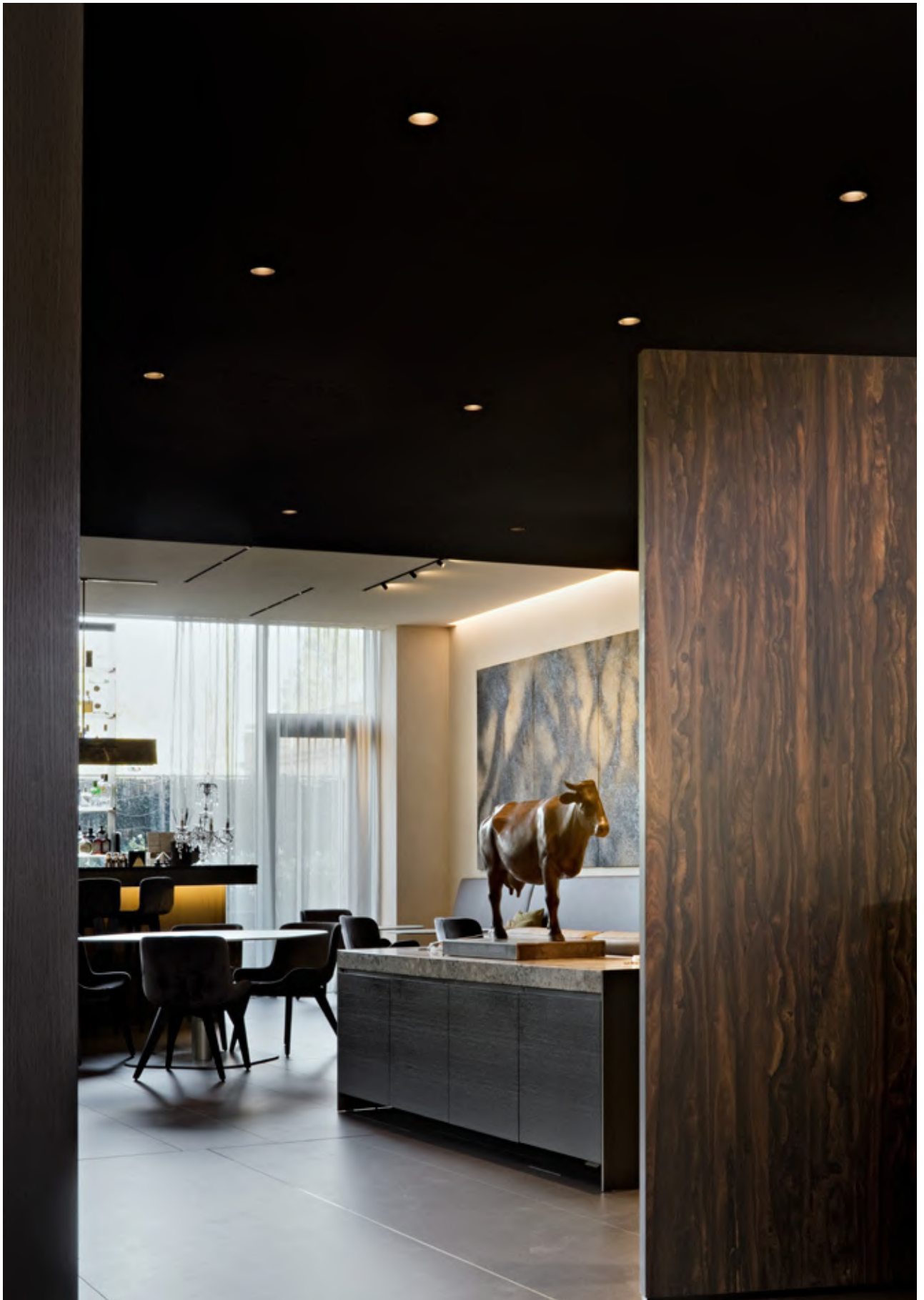

Viu Hotel, Italy



EASY KAP Ø30
FIXED



EASY KAP Ø30
ADJUSTABLE



EASY KAP Ø50
FIXED



EASY KAP Ø50
ADJUSTABLE



POWER LED
UP to 3,2W

LED ARRAY
7,5W



EASY KAP 80 / EASY KAP 80 PLUS
FIXED



EASY KAP 80 / EASY KAP 80 PLUS
ADJUSTABLE



EASY KAP 80 / EASY KAP 80 PLUS
WALL-WASHER



LED ARRAY
UP to 13W

LED ARRAY
Dim-To-Warm
13W

LED
QR-CBC 51
GX5.3

LED
PAR 16
GZ10

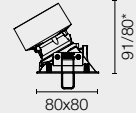
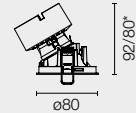
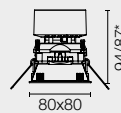
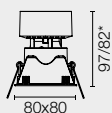
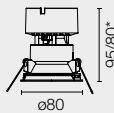

Easy Kap Plus / Easy Kap*

Easy Kap Plus / Easy Kap*

Easy Kap Plus / Easy Kap*

EASY KAP Ø105
FIXED



EASY KAP Ø105
ADJUSTABLE



EASY KAP Ø105
WALL-WASHER



LED ARRAY
23W

LED
QR-CBC 51
GX5.3

LED
PAR 16
GZ10

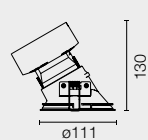
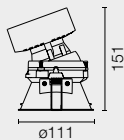
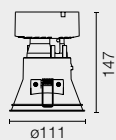

KAP Ø50
FIXED



KAP Ø50
ADJUSTABLE



LED ARRAY
7,5W



KAP 80 / KAP 80 PLUS
FIXED

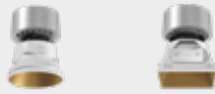

LED ARRAY
UP to 13W

LED ARRAY
Dim-To-Warm
13W

KAP 80 / KAP 80 PLUS
WALL-WASHER



LED
QR-CBC 51
GX5.3

LED
PAR 16
GZ10

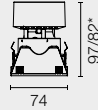
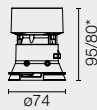

Kap Plus / Kap*

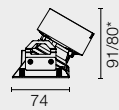
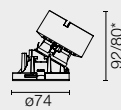

Kap Plus / Kap*

KAP 80 / KAP 80 PLUS
ADJUSTABLE



LED ARRAY
UP to 13W

LED ARRAY
Dim-To-Warm
13W

LED
QR-CBC 51
GX5.3

LED
PAR 16
GZ10

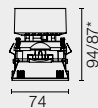
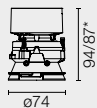

Kap Plus / Kap*

KAP Ø105
FIXED



LED ARRAY
23W

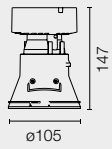

KAP Ø105
ADJUSTABLE



LED
QR-CBC 51
GX5.3

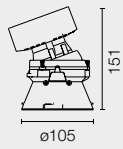

KAP Ø105
WALL-WASHER



LED
PAR 16
GZ10

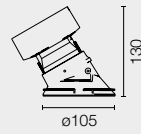

KAP Ø105
DEEP



LED ARRAY
23W

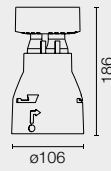

KAP 105
SQUARE



PHOSPHOR LED
17W LED
QR-CBC 51
GX5.3

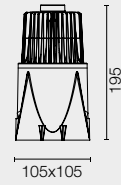

Spot



Medium



Flood



Wide Flood



Wall-Washer

□ B1 Bianco
B1 White



■ GL Oro Opaco
GL Matt Gold



■ 74 Nero
74 Black



■ EQ Rame
EQ Copper



ROUND
Ø80



SQUARE
80



CEILING
Ø100



WALL
Ø100



SUSPENSION
Ø100



LED ARRAY
9,2W



POWER LED
9W

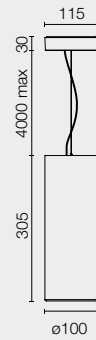
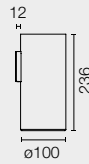
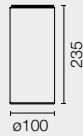

Spot



Medium





Flood

KAP 80 ROUND / SQUARE

Esterno / Outside

 11 Bianco
11 White

 AN Nero
AN Black

 18 Deep Brown
18 Deep Brown

Interno / Inside

 Bianco
White

 Oro Satinato
Matt Gold

 Rame
Copper

 Nero
Black



KAP Ø100

Esterno / Outside

 11 Bianco
11 White

 AS Alluminio Spazzolato
AS Brushed Aluminium

 AN Nero Black
AN Black

 B3 Marrone
B3 Brown

Interno / Inside

 Bianco
White

 Oro Satinato
Matt Gold

 Rame
Copper

 Nero
Black

FLOS
CONTROL BY CASAMBI



c1 C

c1 c1 c1 c1 c1 c1 c1
c1 c1 c1 c1 c1 c1 c1

1 c1
c1

La semplicità del cilindro nasconde un meccanismo intelligente che permette di ottenere una flessibilità incredibile del corpo illuminante.

The simplicity of the cylinder hides an intelligent mechanism that allows for an amazing flexibility of the lighting body.

C1

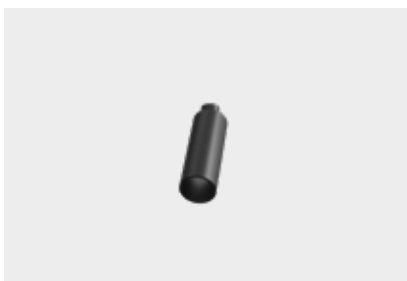

La gamma è composta da due dimensioni progettate per applicazioni a plafone e a parete. La gamma di potenze disponibili ed il parco ottiche dedicato rendono C1 un prodotto ideale per applicazioni in Hotel e ambienti domestici.

The range consists of two sizes, designed for ceiling or wall applications. The range of available powers and the dedicated optics kit make C1 ideal for applications in hotels and homes.

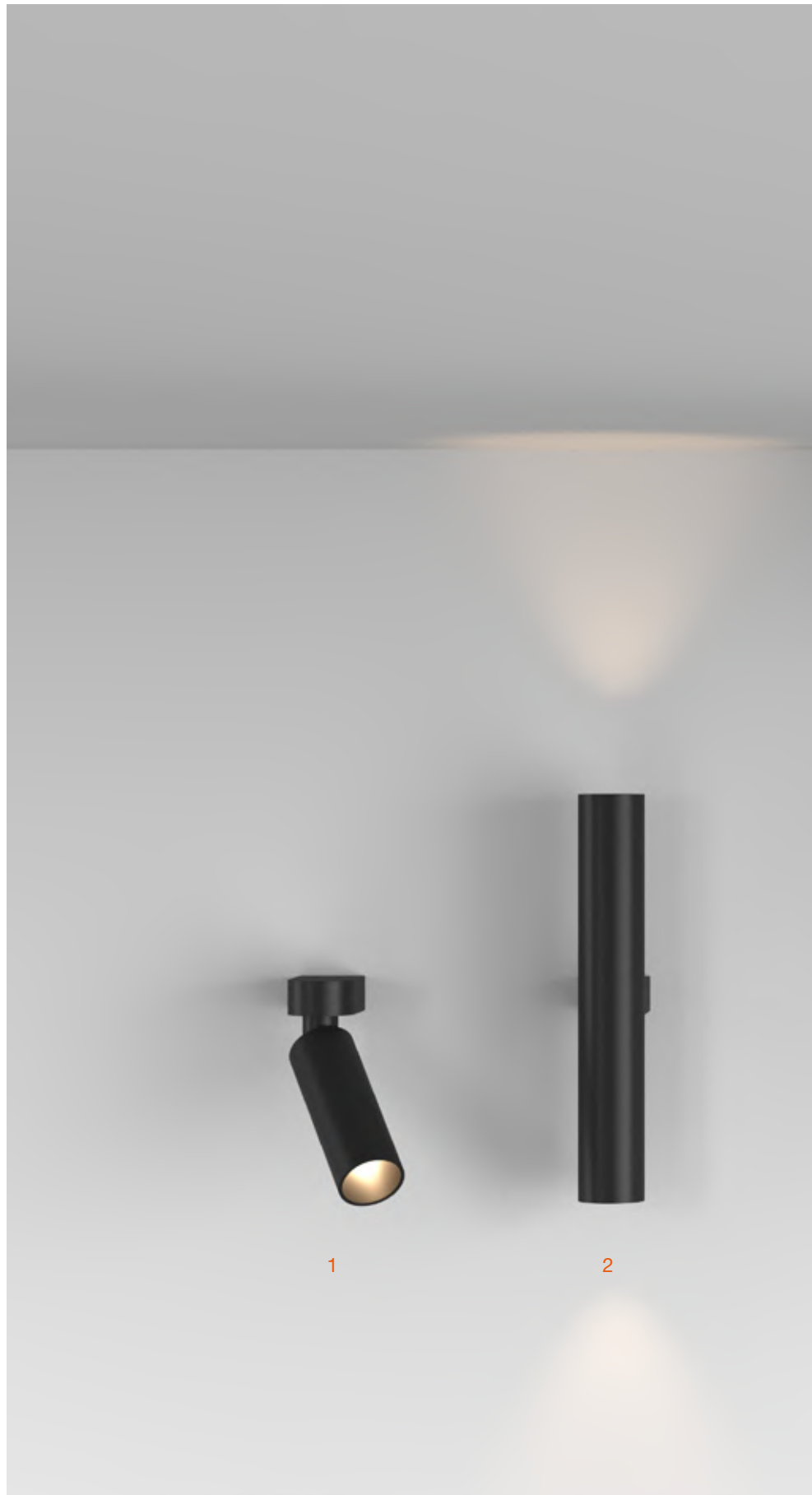

- 1 WALL DOWN
- 2 WALL UP&DOWN
- 3 CEILING



3







Il gruppo ottico arretrato all'interno del corpo nasconde la sorgente luminosa alla vista controllando la luminanza diretta per un effetto comfort totale. Lo speciale snodo integrato nel corpo del prodotto permette di estrarlo ed orientarlo sulla base di 60° sull'asse verticale e 355° sull'asse orizzontale.

The optic group, placed far back on the body, hides the light source from the eye while controlling the direct illuminance for an absolute comfort effect. The special node, integrated into the product's body, allows it to be removed and directed at the base 60° on the vertical axis and 355° on the horizontal axis.



Le versioni a parete sono disponibili per applicazioni mono e biemissione. Le lenti del prodotto garantiscono una distribuzione della luce morbida e diffusa per la luce generale della stanza.

The wall-mounted versions are available for single and double emission applications. The lenses of the product guarantee a soft and diffuse light distribution for general room lighting.

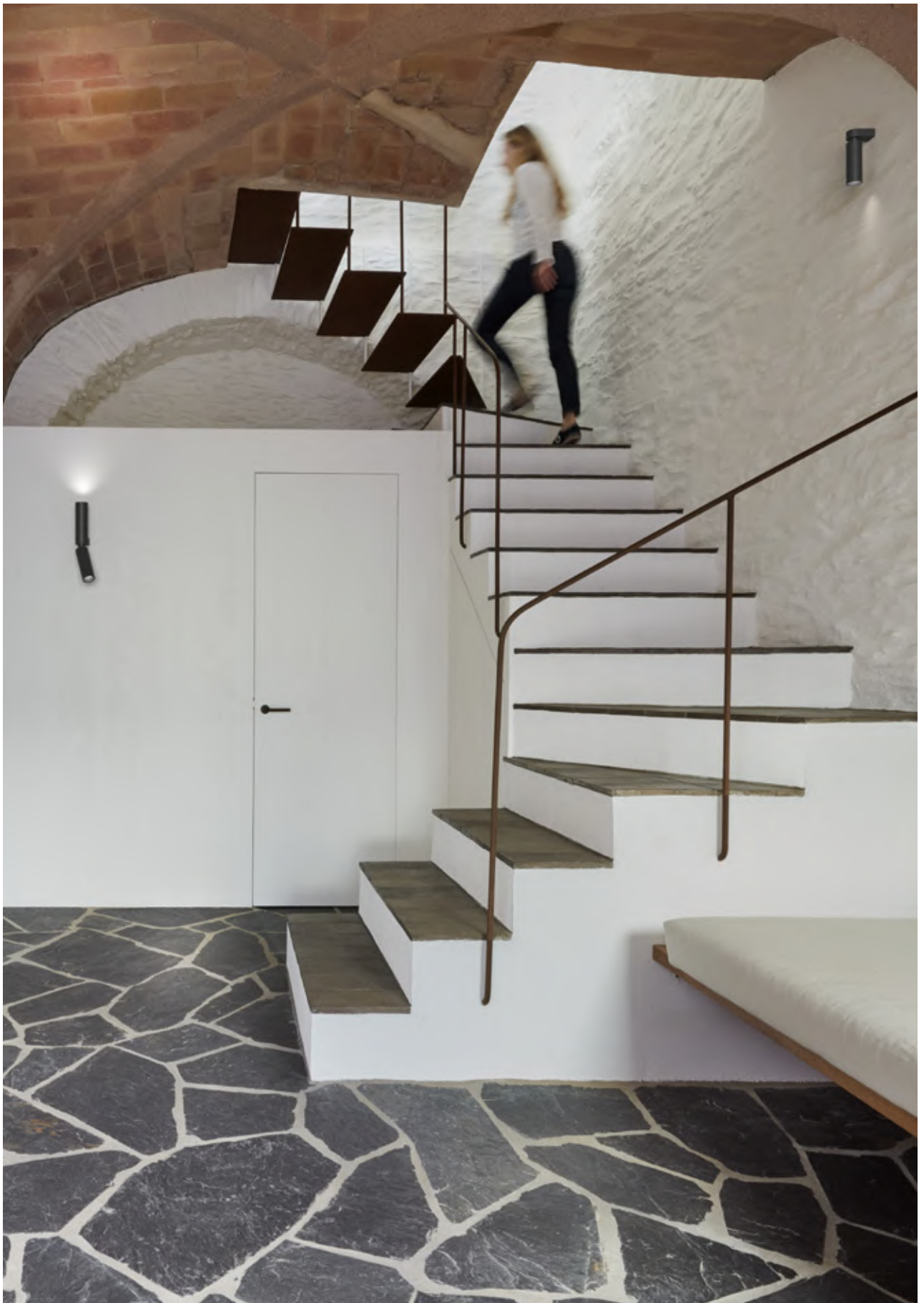

Nelle applicazioni in cui sia necessaria una luce per la lettura è disponibile un'emissione puntuale concentrata, ideale per creare uno scenario rilassante durante le ore notturne.

In applications where reading light is required, a concentrated spot emission is available, which is ideal for creating a relaxing scene during the night hours.







Villa La Saracena



WALL UP&DOWN
SMALL



LED ARRAY
12W

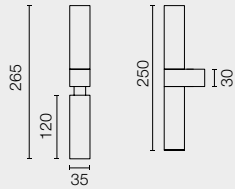

WALL DOWN
SMALL



LED ARRAY
6W

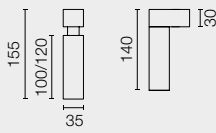

CEILING
SMALL



LED ARRAY
6W



WALL UP&DOWN
LARGE



LED ARRAY
UP TO 28W

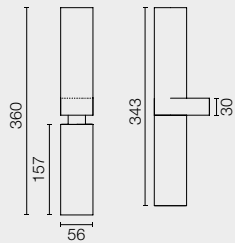

WALL DOWN
LARGE



LED ARRAY
UP TO 14W

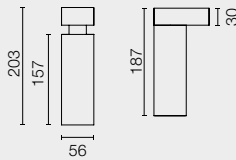

CEILING
LARGE



LED ARRAY
UP TO 14W



□ DY Bianco
DY White

■ DR Antracite
DR Anthracite

■ EQ Rame Spazzolato
EQ Brushed Copper

■ ER Acciaio Spazzolato
ER Brushed Steel

■ ES Bronzo Spazzolato
ES Brushed Bronze



Può essere ruotato di 180° e orientato di 60°.
Can be rotated 180° and swivelled 60°.

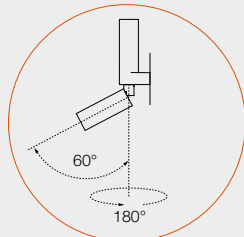

Wall

Può essere ruotato di 355° e orientato di 60°.
Can be rotated 355° and swivelled 60°.

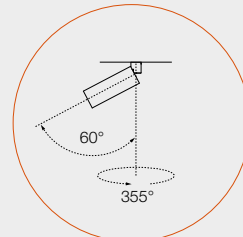

Ceiling



Spot



Medium



Flood



Wide Flood

FLOS
CONTROL BY CASAMBI



FIND

ME

ME

FIND

FIND

ME

ME

FIND

FIND

ME

ME

FIND

Proiettore per interni con sorgente luminosa LED. Disponibile in tre versioni: la versione Mono Point (0, 1 e 2) -costituita da un corpo cilindrico removibile che funge da downlight nella sua posizione superiore e diventa un faretto orientabile nella sua posizione inferiore-, versione Find Me 3 Track e una versione a Sospensione.

Interior lighting projector with LED light source. Available in three versions: Mono Point version (0, 1 and 2) -consisting of a removable cylindrical body that acts as a downlight when set in its upper position and becomes an adjustable projector when set in its lower position-, Find Me 3 Track version and Suspension version.

FIND ME

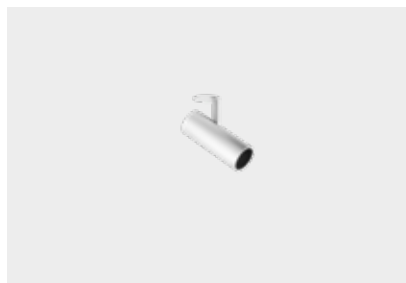
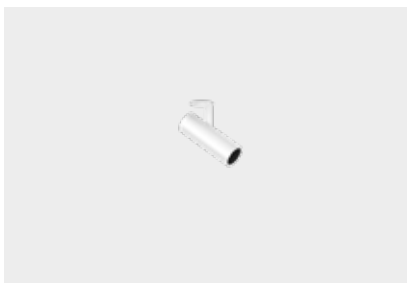

Un'icona senza tempo. Find Me reinterpreta l'archetipo del proiettore tradizionale attraverso dettagli di stile e ricercatezza nell'installazione che lo rendono unico e inimitabile.

A timeless icon. Find Me reinterprets the traditional projector archetype through stylish and refined installation details that make it unique and inimitable.





Questo ingegnoso apparecchio per interni, incassato e orientabile, racchiude un design ultra-minimalista. Find Me 0 riduce le dimensioni del proiettore ai minimi termini reinterpretando in scala ridotta il talento del fratello maggiore Find Me.

This ingenious, recessed and adjustable indoor device features an ultra-minimalist design. Find Me 0 minimizes the size of the projector, reinterpreting the talent of its big brother Find Me on a small scale.







Il Sereno Hotel, Italy

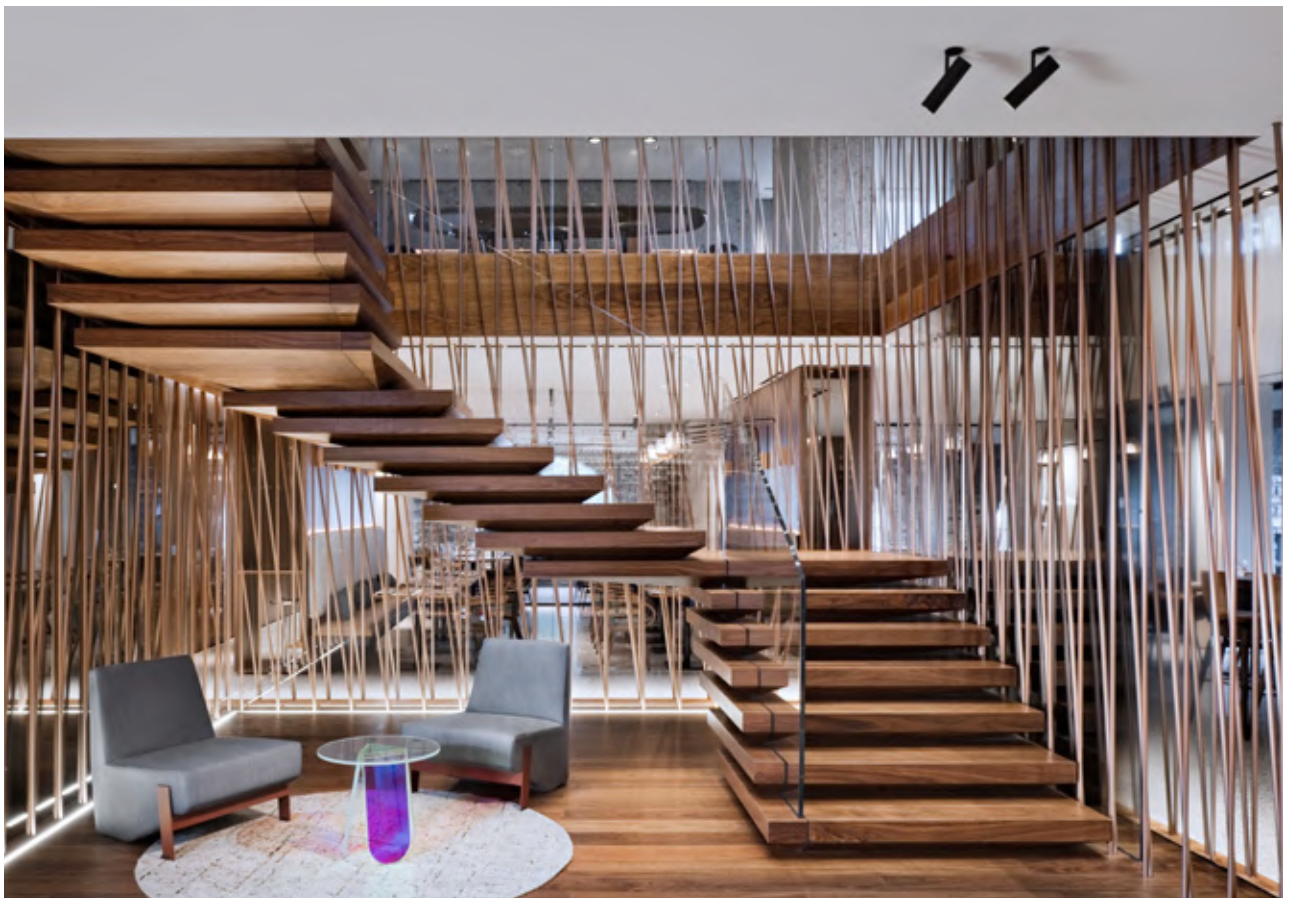
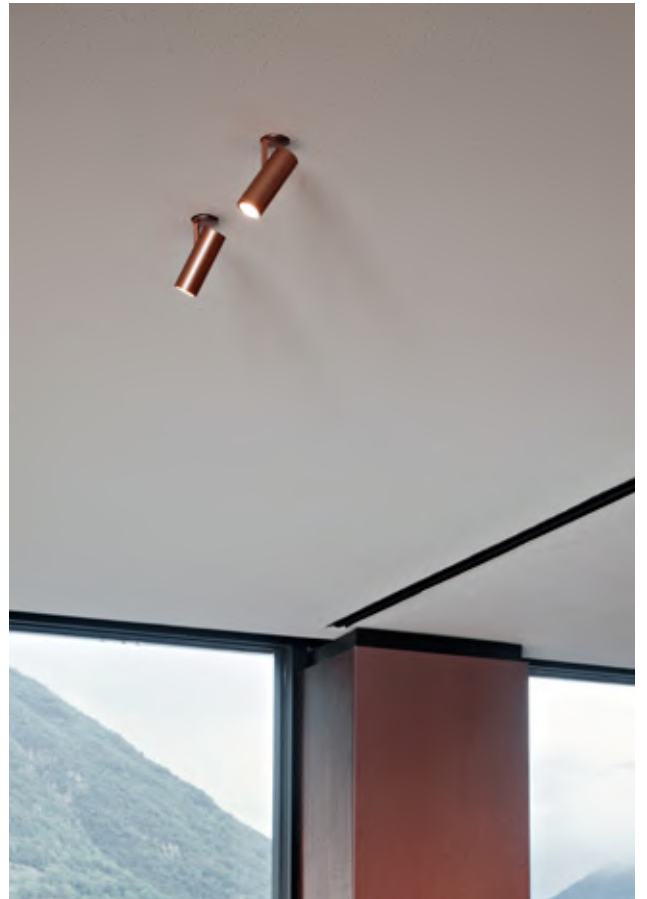



Orientabile ed oscillante grazie alla sua base in grado di ruotare a 360° e al suo braccio in zamak orientabile fino a 70°.

Directional and tilting thanks to its base with 360° rotation capacity and to its arm made of zamak, directional up to 70°.

Sistema di spostamento mediante raccordi elastici su una guida dentata che permettono ai faretti di nascondersi, rimanendo completamente integrati nell'ambiente.

An adjustment system with elastic flanges on a toothed guide, permits concealing the spotlights, thus becoming totally integrated into the environment.



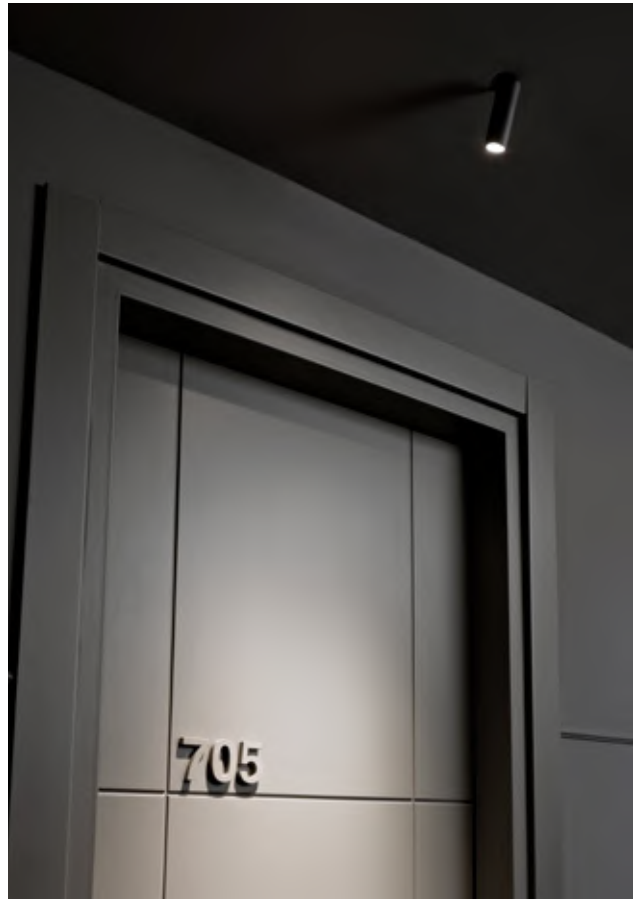

Hotel Colombo, Italy
Top



Carbonado Energy,
South Africa

FIND ME 0
TRIM / NO TRIM

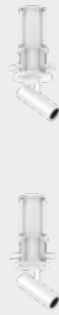

POWER LED
3,5W

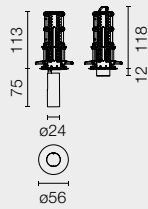

FIND ME 1
TRIM / NO TRIM

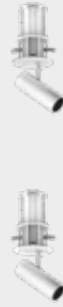

POWER LED
6W

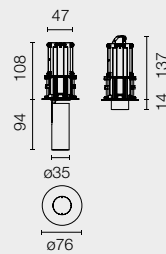

FIND ME 2
TRIM / NO TRIM



POWER LED
10W

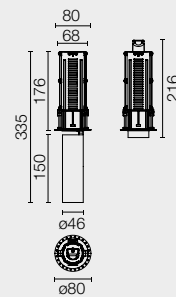

FIND ME 3
TRACK



POWER LED
28W

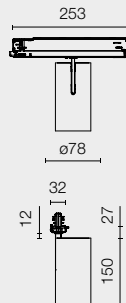

FIND ME 1
SUSPENSION



POWER LED
6W



FIND ME MONO POINT *

□ 30 Bianco
30 White



◻ 06 Cromo
06 Chrome



■ 14 Nero
14 Black



TRACK **

□ 30 Bianco
30 White



■ 14 Nero
14 Black



FIND ME SUSPENSION

□ 30 Bianco
30 White



◻ 06 Cromo
06 Chrome



■ 14 Nero
14 Black



Colori del Cilindro Schermante (compresi)
Screening Cylinder Colours (included)

■ Arancio
Orange



■ Viola
Violet



■ Nero
Black



Può essere ruotato di 360° e orientato di 70° * / 90° **.
Can be rotated 360° and swivelled 70° * / 90° **.

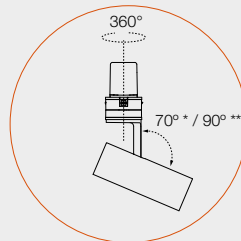

FLOS
CONTROL BY CASAMBI



UT

UT UT
UT UT

H

D

C

F

UT

UT

Collezione di proiettori LED ad alta potenza dal design minimalista ed elegante. Ampia varietà di soluzioni, con fonti luminose e ottiche che possono risolvere qualunque necessità di illuminazione. Possibilità di installazione su binario trifase per la massima flessibilità o a soffitto per una migliore integrazione nell'architettura. Efficienza e affidabilità.

A collection of minimalist and elegant high-power LED projectors. A wide range of solutions with light sources and optics for all your lighting needs. Possibility of installing a three-phase track for maximum flexibility or ceiling installation for a better integration in the architecture. Efficiency and reliability.

UT

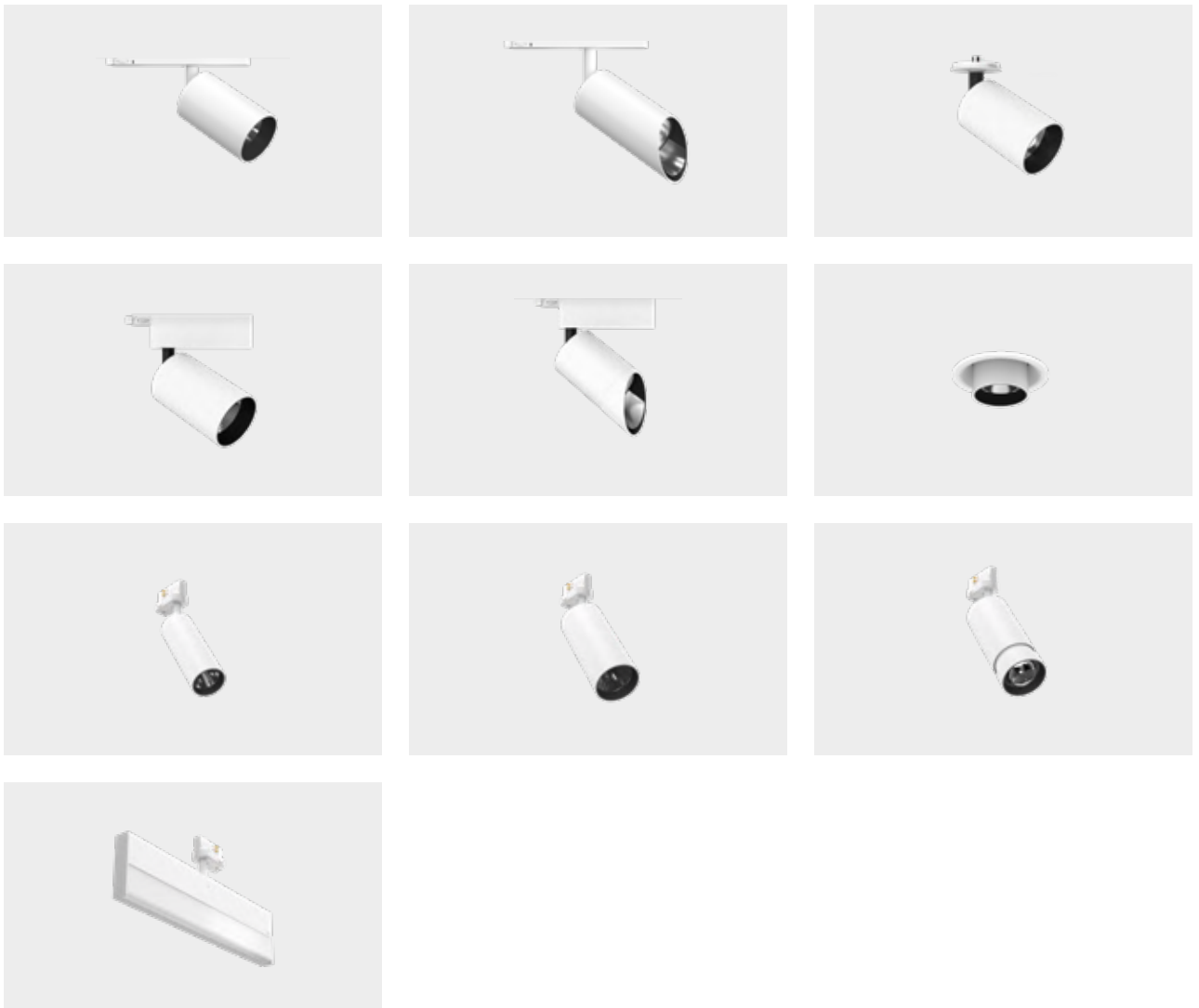



Victoria Beckham Store,
London



UT SPOT

Proiettore professionale ad alta performance disponibile con un'ampia varietà di effetti luminosi.

High performance professional projector available with a wide range of lighting effects.

1 Ottica multi-chip per ottenere angoli di apertura molto stretti.
Multichip optical design to achieve very narrow beam angles.

2 Versione wall-washer disponibile nella versione track da Ø86.
A wall-washer version is available in Ø86 track version.



1



2

UT SPOT ALL WHITE

Nuove versioni realizzate nell'esclusiva finitura "all white" per la massima integrazione nell'ambiente.

New versions with the exclusive "all white" finish for the best possible integration into the environment.

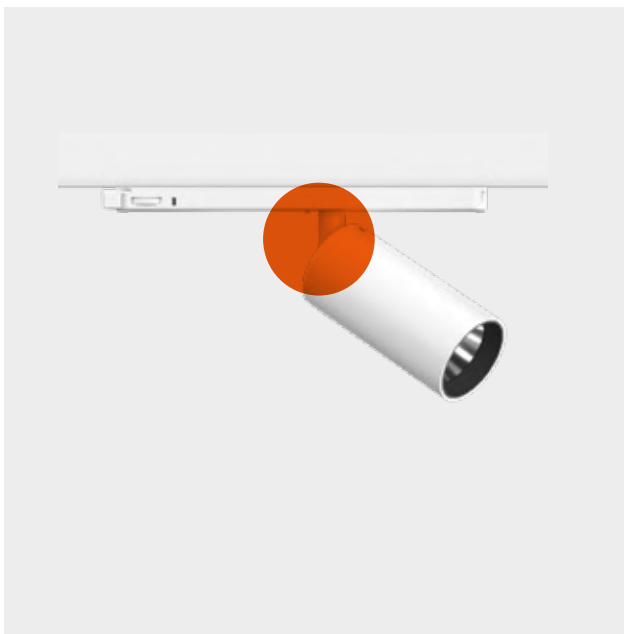

UT PRO SURFACE

Versioni per installazione in superficie con basetta integrata e regolatore di potenza incluso.

Versions for surface installation with integrated base and power regulator included.





Flos Booth Euroshop Fair,
Germany



Central European University,
Budapest
Bottom

Boutek, Milan
Top

- 1 UT SPOT TRACK Ø57
- 2 UT SPOT TRACK Ø86 WALL-WASHER
- 3 UT DOWNLIGHT Ø86
- 4 UT PRO SURFACE 150

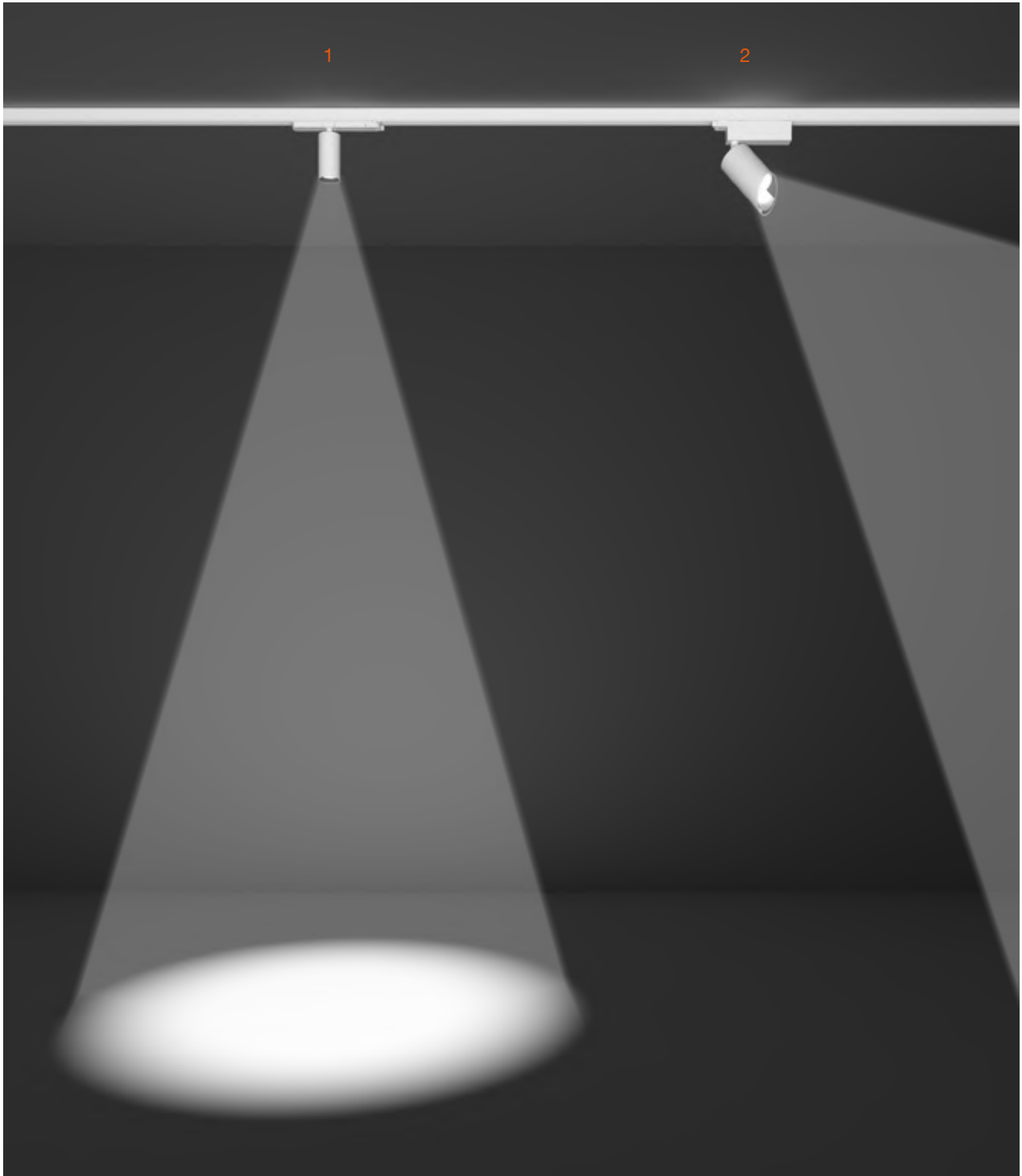

Un programma professionale completo ideale per gestire qualsiasi applicazione retail. Il parco ottiche esteso, le potenze e la versatilità che caratterizza ogni modello rendono la gamma UT una soluzione perfetta per ogni tipo di esigenza tecnica all'interno di uno spazio espositivo.

Complete professional program, ideal for controlling any retail application. The extended optics kit, powers and versatility that characterize each model make the UT range the perfect solution for any technical requirement of display areas.

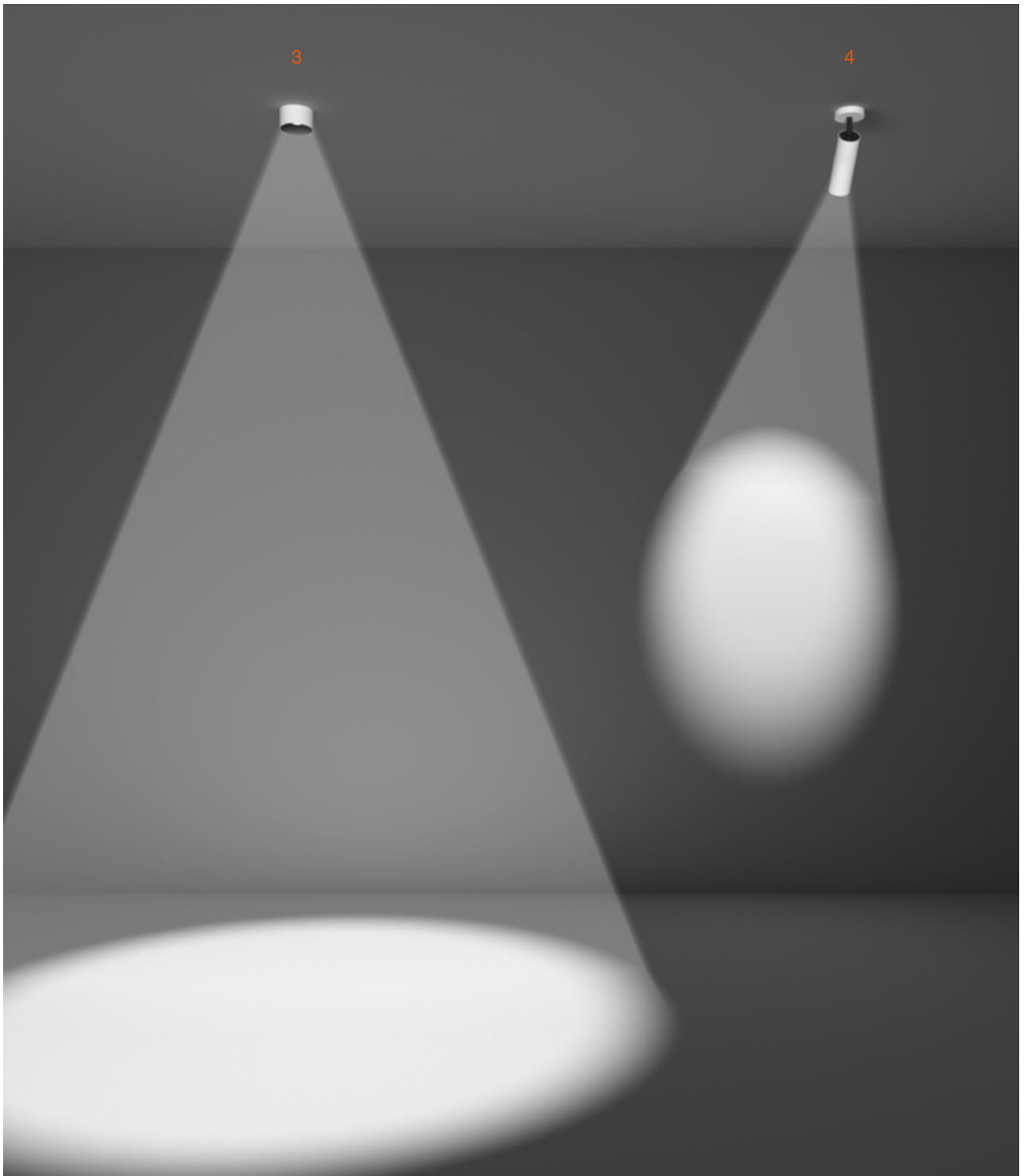



De Witte Duif,
Belgium

Sistema di regolazione tramite una guida dentata che consente di nascondere i proiettori, integrandoli nell'ambiente.

An adjustment system on a toothed guide permits concealing the spotlights, thus becoming integrated into the environment.

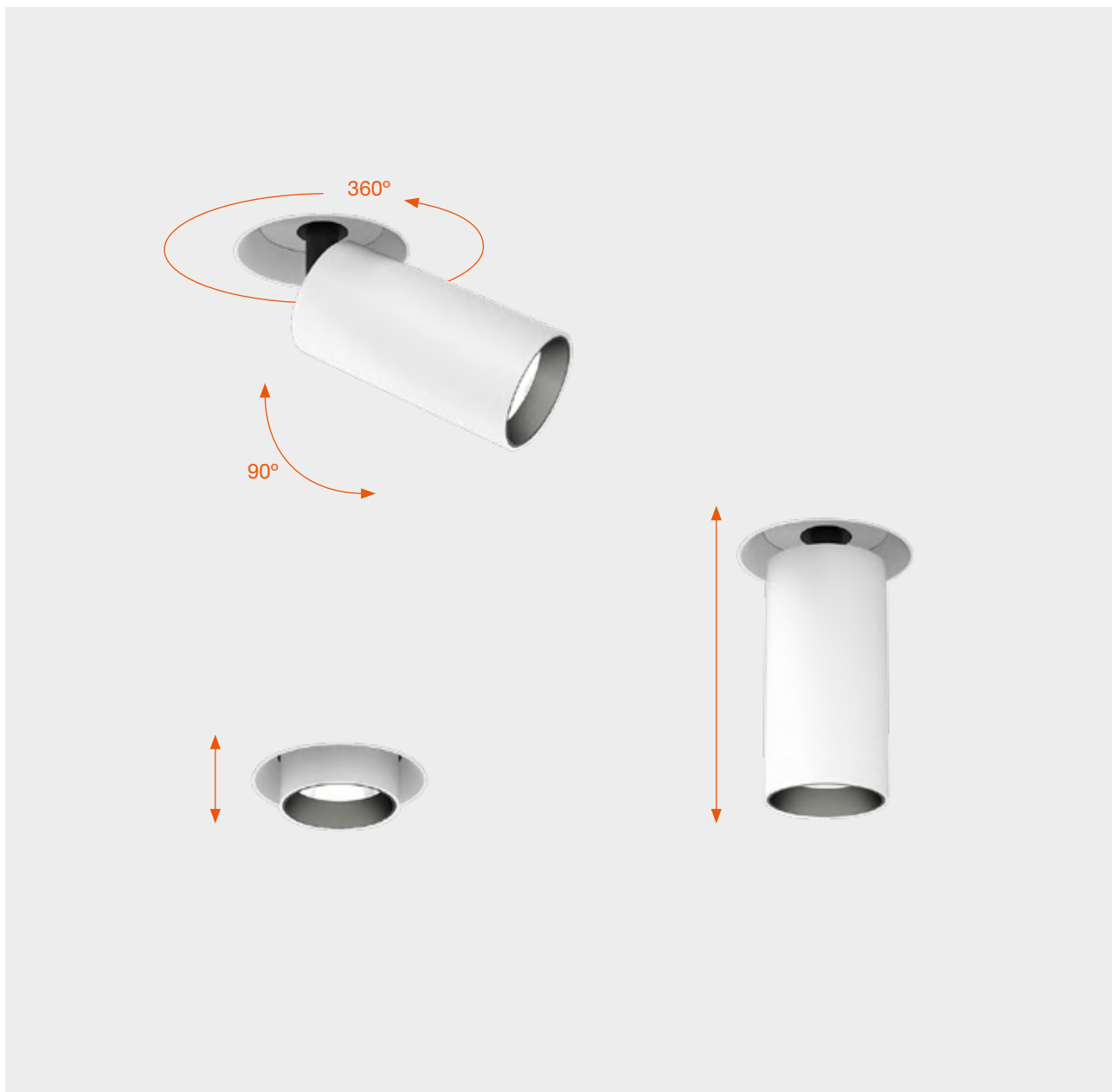





TRACK
Ø57

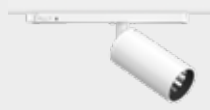

LED ARRAY
23,5W

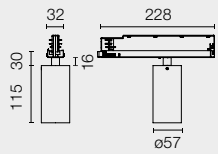

Dali Version

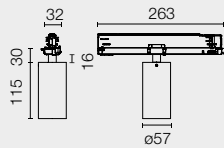

TRACK
Ø57



LED ARRAY
23,5W

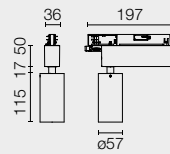

Dali Version

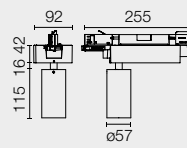

CEILING
Ø57



LED ARRAY
23,5W

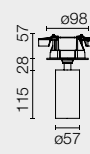

Super Spot



Spot



Medium



Flood

□ 30 Bianco
30 White

■ 14 Nero
14 Black

□ 30.78 All White
30.78 All White

□ 30 Bianco
30 White

■ 14 Nero
14 Black



Può essere ruotato di 360° e orientato di 90°.
Can be rotated 360° and swivelled 90°.

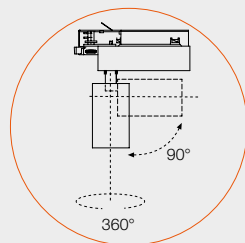

TRACK
Ø86

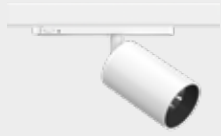

**LED ARRAY
HIGH PERFORMANCES
33W
PHOSPHOR LED
27W**

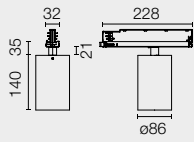

Dali Version

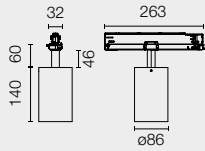

TRACK
WALL-WASHER
Ø86



**LED ARRAY
HIGH PERFORMANCES
33W**

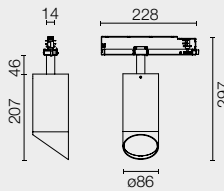

Dali Version

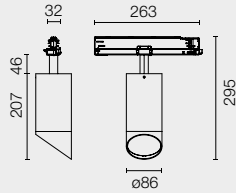

CEILING
Ø86



**LED ARRAY
HIGH PERFORMANCES
33W
PHOSPHOR LED
31W / 34W**

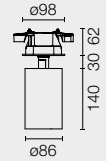

TRACK
Ø86



**PHOSPHOR LED
31W / 34W**

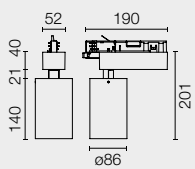

**LED ARRAY
HIGH PERFORMANCES
33W**

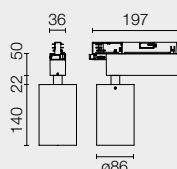

Dali Version

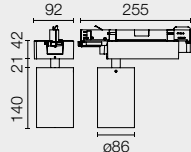

TRACK
WALL-WASHER
Ø86



**LED ARRAY
HIGH PERFORMANCES
33W**

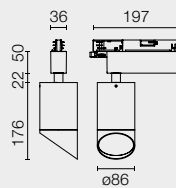

TRACK
MULTICHIP
Ø86



**TOP LED
11,5W**

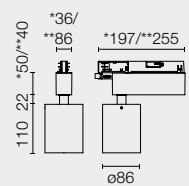

*Dimable/Non Dimable
**Dali Version

RECESSED

SURFACE

TRIM / NO TRIM
Ø57



LED ARRAY
18W

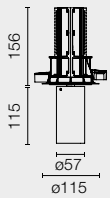
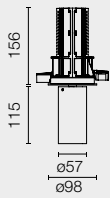

TRIM / NO TRIM
Ø86



LED ARRAY
HIGH PERFORMANCES
27W

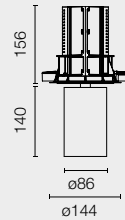
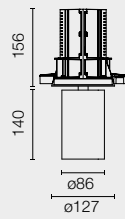

UT PRO SURFACE
150



LED ARRAY
21W

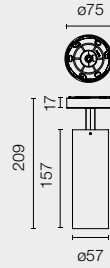

UT PRO SURFACE
175



LED ARRAY
35,3W

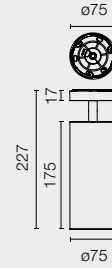

Può essere ruotato di 360° e orientato di 90°.
Can be rotated 360° and swivelled 90°.

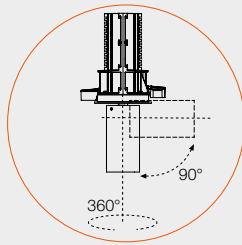

Spot



Medium



Flood

□ 30 Bianco
30 White



■ 14 Nero
14 Black



□ 30 Bianco
30 White



■ 14 Nero
14 Black



UT PRO 150
GA-69



LED ARRAY
23,5W

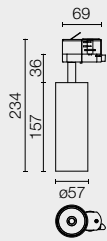

UT PRO 175
GA-69



LED ARRAY
35,3W

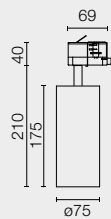

UT PRO 175 LENS
GA-69



LED ARRAY
35,3W

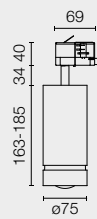

UT PRO WALL-WASHER
GA-69



TOP LED
25,5W

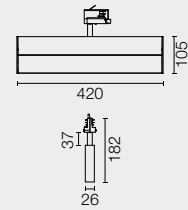

Compatible con The Tracking Power.
Compatible with The Tracking Power.



Spot



Medium



Flood



Wall-Washer

BON

BON JOUR

BON JOUR BON JOUR

BON JOUR BON JOUR

BON JOUR

BON JOUR BON JOUR

BON JOUR BON JOUR

JOUR

Elementi ad incasso LED dal design particolare, grazie al bordo di piccole dimensioni che definisce la presenza dell'apparecchio d'illuminazione. Disponibile in tre misure, con diverse ottiche per una maggiore personalizzazione. Linee pure accentuate dalle finiture raffinate, nelle versioni neutre e metallizzate.

Recessed LED with an unusual design, thanks to the small edge that defines the presence of the luminaire. Comes in three sizes with different optics for a better personalisation. Pure lines highlighted with the refined finishes, in neutral and metal plated versions.

BON JOUR

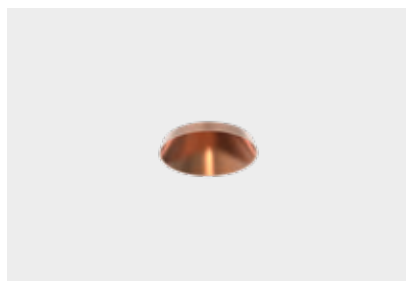
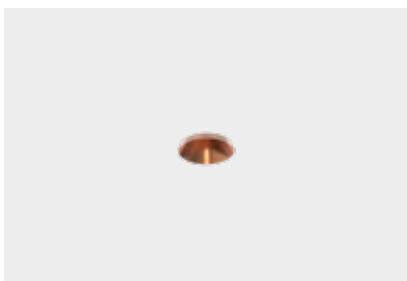

Bon Jour sfrutta un iconico recuperatore conico a vista caratterizzato da un'esclusiva geometria interna che permette di eliminare completamente l'abbagliamento visivo fornendo al tempo stesso una meravigliosa illuminazione diffusa.

Bon Jour exploits an iconic conical light retriever visible after the installation. It is characterized by a unique internal geometry allowing it to completely eliminate visual glare and providing beautiful diffuse lighting at the same time.

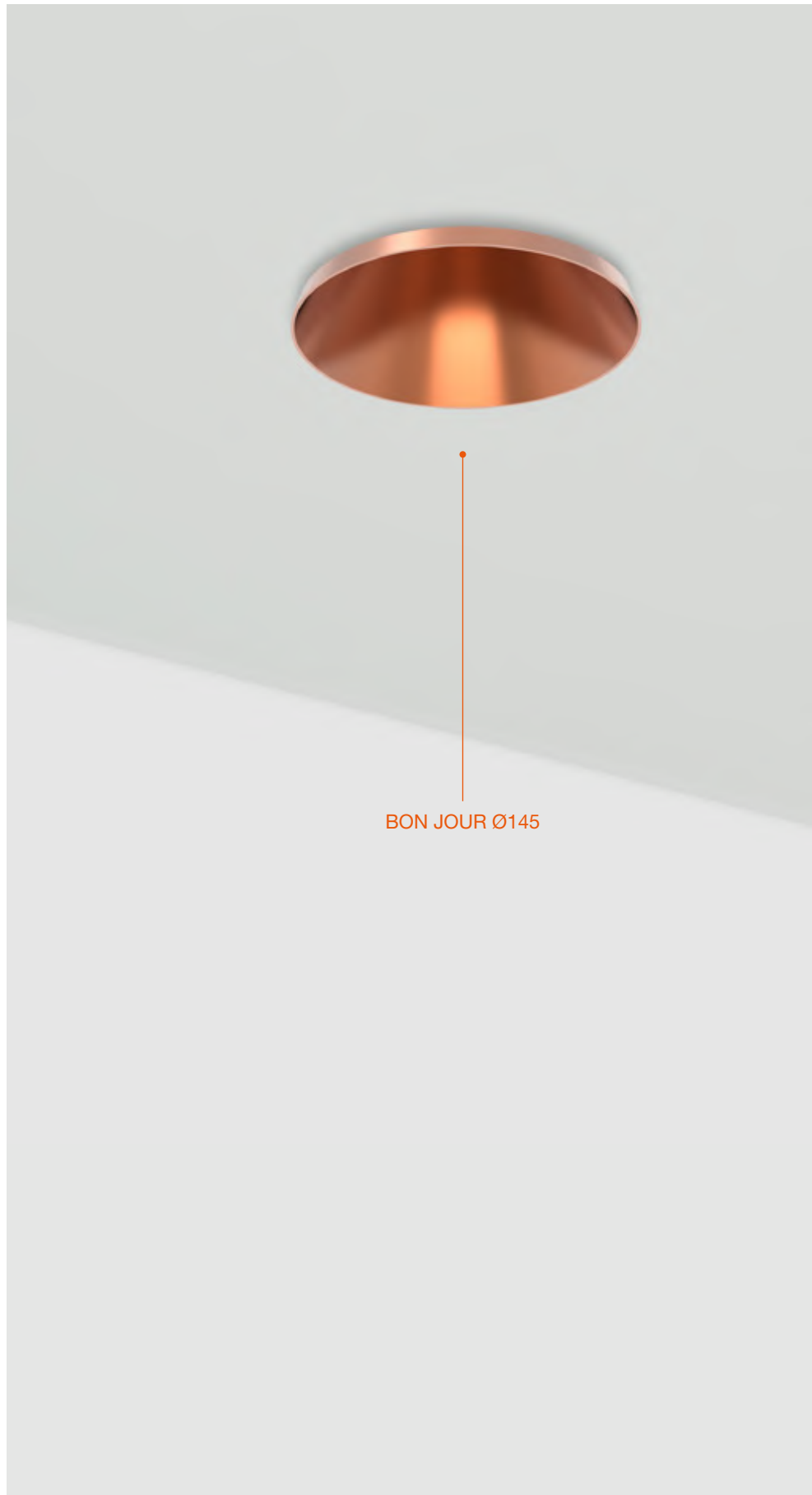

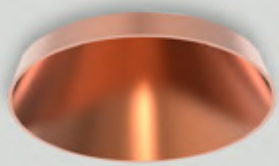

BON JOUR Ø90

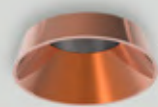

BON JOUR Ø45

Un prodotto unico nel suo genere, Bon Jour reinterpreta il concetto di downlight attraverso un design unico abbinato a materiali e finiture di altissima qualità.

A unique product in its category, Bon Jour reinterprets the concept of downlighting through a remarkable design combined with the highest quality materials and finishes.

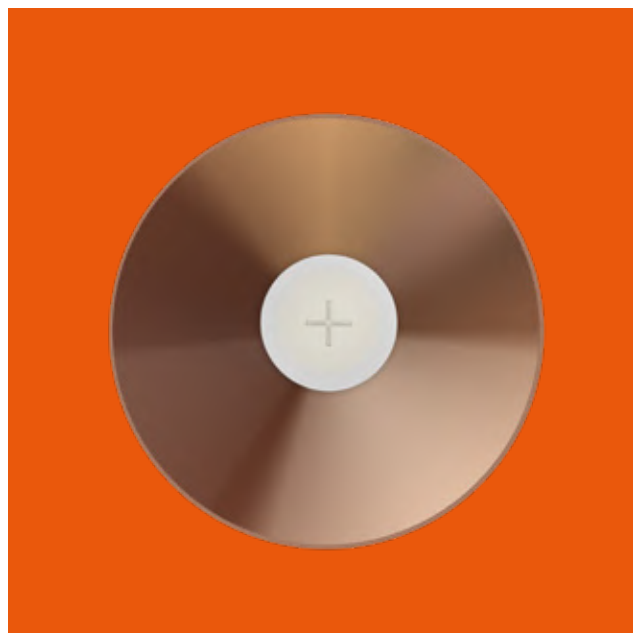
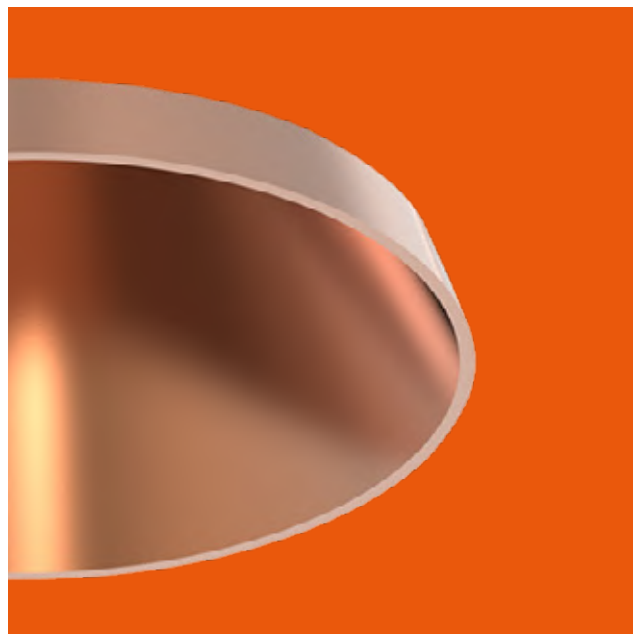





BON JOUR
Ø45



POWER LED
6W



BON JOUR
Ø90



LED ARRAY
13,5W

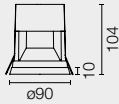

BON JOUR
Ø145



LED ARRAY
36W

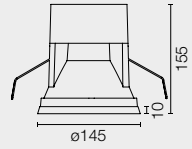

01 Bianco
01 White



CU Rame
CU Copper



14 Nero
14 Black



FLOS
CONTROL BY CASAMBI



Fort Knox Wall è un apparecchio che presenta una struttura robusta e che produce un fascio di luce indiretta molto potente, perfetto per case con tetti alti, sfruttandoli come diffusore naturale.

Fort Knox Wall is a luminaire with coarse structure that produces an indirect and very powerful light beam, perfect for homes with protruding ceilings, working as natural diffuser.

FORT KNOX



FORT KNOX WALL

Incredibilmente compatto e discreto, Fort Knox Wall caratterizza l'ambiente con una luce indiretta estremamente controllata e omogenea.

Incredibly compact and discreet, Fort Knox Wall characterizes the environment with extremely controlled and homogeneous indirect light.

Livella integrata per una facile installazione. Esclusiva lente ad alta efficienza che riesce a orientare il fascio di luce verso l'alto.
Level for easy, integrated installation. Highly efficient lens which directs the beam of light upwards.

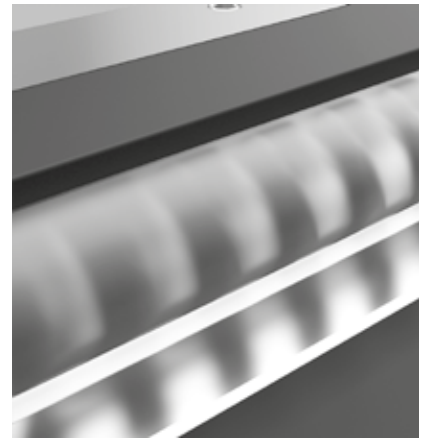

FORT KNOX WALL MINI

La forte asimmetria dell'effetto consente di gestire in maniera semplice gli spazi più complessi anche nella nuova versione miniaturizzata Fort Knox Wall Mini.

The strong asymmetry of the effect eases the management of the most complex spaces even in the new miniaturized version Fort Knox Wall Mini.







Sensory Apartment
Palazzo Poste, Italy

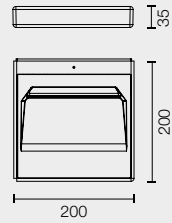
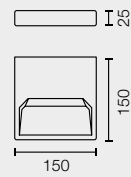

FORT KNOX
WALLPOWER LED
35WFORT KNOX
WALL MINIPOWER LED
25WAsymmetric
Flood

□ 40, 30 Bianco
40, 30 White



◻ 05 Alluminio Lucido
05 Polished Aluminium



■ 14 Nero/RAL 9005
14 Black



Led Curtain, In-Finity, Circle of Light, Light Cut
Mini, Super Flat, Light Bell, Thin Led, Light
Supply, Johnny, Wan Spot, Wan Downlight, G-O,
The BlockOfLight

SOPHISTICATED COMMODITIES

LED CURTAIN

Designed by Flos Architectural

Apparecchio ad incasso con sorgente luminosa LED. Appositamente progettato per illuminazioni wall-washer, Led Curtain contiene lenti ellittiche che danno una perfetta distribuzione luminosa. La famiglia Led Curtain è prodotta in varie lunghezze modulabili tra loro, in modo tale da potersi adattare facilmente ai diversi spazi e, grazie alle sue ridotte dimensioni, si integra facilmente nell'architettura.

Family of circular ceiling-mounted recessed luminaires, which are totally integrated owing to Soft Architecture technology. The Circle of Light is comprised of an outer frame made with composite that houses a metal structure. This, in turn, acts as support for the latest generation LED spotlights. Its lenses optimise the luminous performance of the luminaire together with anti-glare cones that guarantee high visual comfort.

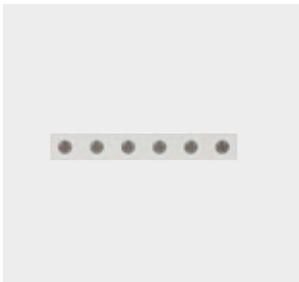

Find out more at
flos.com/ledcurtain

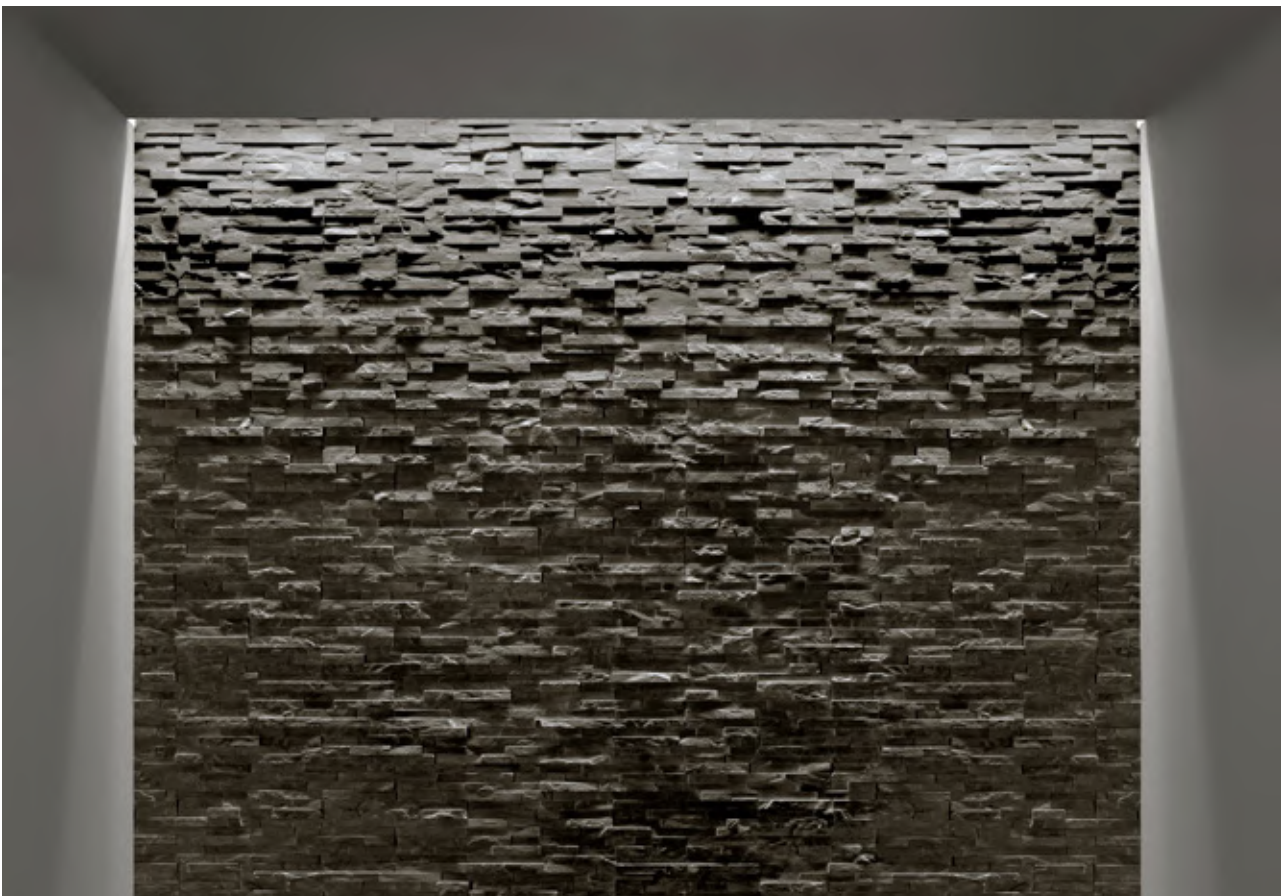



IN-FINITY

Designed by Flos Architectural

Per professionisti che cercano un impianto d'illuminazione principale per uffici o spazi pubblici: In-Finity è un sistema d'illuminazione LED che offre soluzioni adeguate per qualunque tipo di impianto, con apparecchi d'illuminazione disegnati per l'utilizzo sia come sorgente luminosa singola che come linea continua di luce. In-Finity non solo fornisce comfort visivo ed efficienza ma combina alte prestazioni con un'estetica impeccabile e una costruzione di massima qualità. Tutte le esigenze di un progetto possono essere soddisfatte avendo a disposizione tre larghezze del profilo, diverse alternative di installazione (incassata, trim e no trim, in superficie e a sospensione) e versioni di luce diffusa o spot per rispondere ai requisiti ambientali del progetto.

For lighting professionals looking for the backbone of a lighting installation for an office or public space project, the In-Finity LED lighting system offers coherent solutions suitable for any kind of installation, with luminaires designed for use as a single light source or arranged in an infinite light line. In-Finity delivers visual comfort and energy efficiency, combining high performance with impeccable aesthetics and top quality construction. All project needs can be satisfied with combinations of the three profile widths, the various installation options (recessed trim and no trim, surface-mounted and suspended) and diffuse or concentrated glare-free light versions to meet ambient design requirements.

Profilo modulare per installazione ad incasso. Disponibile in tre sezioni diverse (35 e 70 mm) può essere adattato a qualsiasi contesto architettonico grazie ad una estetica essenziale e puramente tecnica. L'emissione luminosa del profilo può essere personalizzata grazie agli schermi accessori disponibili per luce diffusa e luce controllata.

Modular profile for recessed installation. Available in three different sections (35 and 70 mm). It can be adapted to any architectural environment thanks to its subtle and purely technical aesthetics. The profile's lighting emission can be customized thanks to the optional screens available for both diffuse and controlled light.



Find out more at
flos.com/infinity35



Find out more at
flos.com/infinity70

RECESSED



Porcelanosa Showroom,
Spain



Fantini Showroom, Italy



Gomarco Headquarters,
Spain

Profilo modulare per installazione a plafone e parete. Disponibile in tre sezioni diverse (25, 35 e 70mm) può essere adattato a qualsiasi contesto architettonico grazie ad una estetica essenziale e puramente tecnica. L'emissione luminosa del profilo può essere personalizzata grazie agli schermi accessori disponibili per luce diffusa e luce controllata.

Modular profile for ceiling and wall installation. Available in three different sections (25, 35 and 70 mm). It can be adapted to any architectural environment thanks to its subtle and purely technical aesthetics. The profile's lighting emission can be customized thanks to the optional screens available for both diffuse and controlled light.

SURFACE

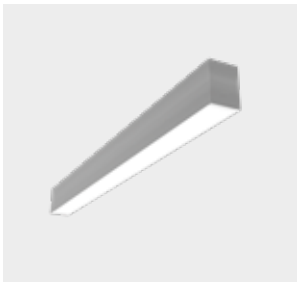

Profilo modulare per installazione a sospensione. Disponibile in tre sezioni diverse (25, 35 e 70mm) può essere adattato a qualsiasi contesto architettonico grazie ad una estetica essenziale e puramente tecnica. L'emissione luminosa del profilo può essere personalizzata grazie agli schermi accessori disponibili per luce diffusa e luce controllata.

Modular profile for suspension installation. Available in three different sections (25, 35 and 70 mm). It can be adapted to any architectural environment thanks to its subtle and purely technical aesthetics. The profile's lighting emission can be customized thanks to the optional screens available for both diffuse and controlled light.

SUSPENSION





CIRCLE OF LIGHT

Designed by Flos Architectural

Famiglia di apparecchi circolari da incassare nel soffitto, completamente integrati grazie alla tecnologia Soft Architecture. Il Black Circle è formato da una cornice esterna realizzata in materiale composito che a sua volta alloggia una struttura metallica atta a fungere da supporto per i faretti LED di ultima generazione. Dispone di lenti che ottimizzano l'efficienza luminosa dell'apparecchio e di coni antiabbagliamento che garantiscono un alto comfort visivo.

Family of circular ceiling-mounted recessed luminaires, which are totally integrated owing to Soft Architecture technology. The Circle of Light is comprised of an outer frame made with composite that houses a metal structure. This, in turn, acts as support for the latest generation LED spotlights. Its lenses optimise the luminous performance of the luminaire together with anti-glare cones that guarantee high visual comfort.

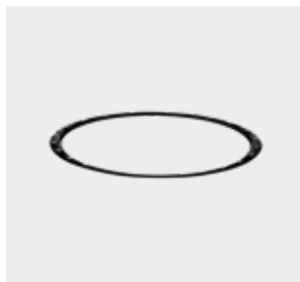

Find out more at
flos.com/circleoflight



Private Hall Entrance,
Spain

LIGHT CUT MINI

Designed by Flos Architectural

Sistema strutturale integrato nell'architettura che permette l'installazione sia di apparecchi di illuminazione diretta che apparecchi di illuminazione indiretta. Il sistema Light Cut Mini può essere integrato con faretti LED di ultima generazione, faretti analogici o faretti ad alogenuri metallici. L'illuminazione ambientale è disponibile a fluorescenza, a LED ed a LED RGB.

A structural system integrated into the architecture, which permits mounting direct and indirect lighting gear. The Light Cut Mini system can be equipped with latest generation LED spotlights, halogen spotlights or metal halide spotlights. The ambient lighting is available in fluorescent, LED and in RGB LED lamps.

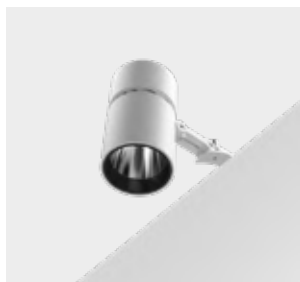

Find out more at
flos.com/lightcutmini



Fantini Showroom, Italy

SUPER FLAT

Designed by Flos Architectural

Famiglia di apparecchi di illuminazione generale (di minimo impatto grazie al loro profilo ridotto) con distribuzione luminosa diretta e indiretta. Dotata di sorgenti luminose LED che oltre ad offrire un flusso luminoso ottimale ed un alto comfort visivo, consentono di ridurre al minimo le perdite di energia.

Family of general lighting luminaires (minimal visual impact thanks to their reduced profile) with direct and indirect light distribution. Equipped with LED lighting sources that supply an optimal flow of light, great visual comfort and minimising energy losses.

SUSPENSION



Find out more at
flos.com/superflat

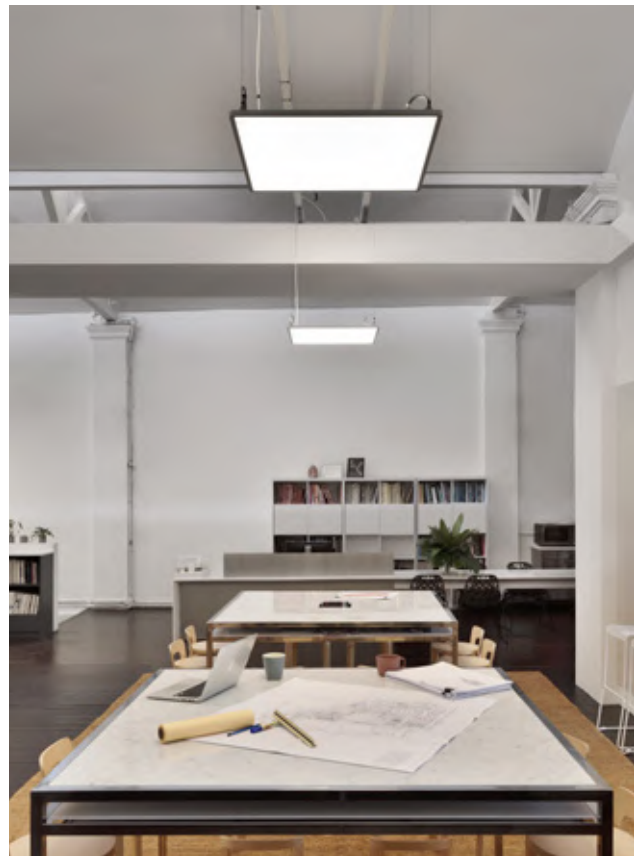

Offices, Singapur

SURFACE



Defant's Club Gym, Italy





LIGHT BELL

Designed by Piero Lissoni

Apparecchio di illuminazione generale a sospensione da installare in ambienti interni. È dotato di sorgente luminosa LED di ultima generazione ad alta efficienza e di diffusore in termoplastica tecnica a basse perdite. Il riflettore dell'apparecchio in alluminio smussato è disponibile in diverse finiture all'interno ed esterno, e in vetro trasparente.

Suspended general lighting luminaire for indoor mounting. It has a high efficiency, latest generation LED light source and a low-loss technical thermoplastic diffuser. The luminaire reflector is made of spun aluminium, available in different patterns inside as well as outside and in transparent glass.



Find out more at
flos.com/lightbell





THIN LED

Designed by Flos Architectural

Profilo a parete per illuminazione indiretta. Essenziale e minimale per una perfetta integrazione nello spazio architettonico circostante. Di dimensioni ridotte, ma con un altissimo rendimento luminoso, è un apparecchio unico per un'illuminazione asimmetrica perfettamente uniforme.

Wall-mounted profile for indirect lighting. Essential and minimal for perfect integration into the surrounding architectural space. Thin, but with really high lighting performances. A unique device for even and spotless asymmetrical lighting.



Find out more at
flos.com/thinled





Sublime Store, Belgium

LIGHT SUPPLY

Designed by Flos Architectural

Elementi ad incasso ad alta potenza con moduli LED di ultima generazione. Dimensioni compatte che presuppongono la massima integrazione nell'architettura. Disponibile in versione fissa, wall-washer e regolabile, anche con accessori professionali di schermatura.

High-power recessed elements with avant-garde LED modules. Compact size with maximum integration into the architecture. Comes in fixed, wall-washer and adjustable versions, with professional screening accessories.



Find out more at
flos.com/lightsupply



Sublime Store, Belgium

JOHNNY

Designed by Flos Architectural



Find out more at
flos.com/johnny

Proiettore versatile grazie alle due dimensioni disponibili e alla grande varietà di diversi tipi di installazione. Possibilità di massima integrazione nella versione a incasso o di grande presenza estetica nelle versioni a semi-incasso con finiture in materiali esclusivi. Dotato di sistema meccanico di rotazione, che ne garantisce l'efficienza, integrazione e stabilità nel tempo. Comprende versioni per l'installazione rapida senza cornice con sistema Fast&Perfect.

Versatile projector thanks to the two available sizes and the great variety of installation possibilities. Possibility of maximum integration in the recessed version, or of a stranger aesthetic presence in the semi-recessed versions with exclusive finishes. Fitted with a mechanical rotation system that ensures efficiency, integration and stability over time. Includes different versions for a fast frame-free installation with the Fast&Perfect system.



ROUND 80 RECESSED



ROUND 120 RECESSED

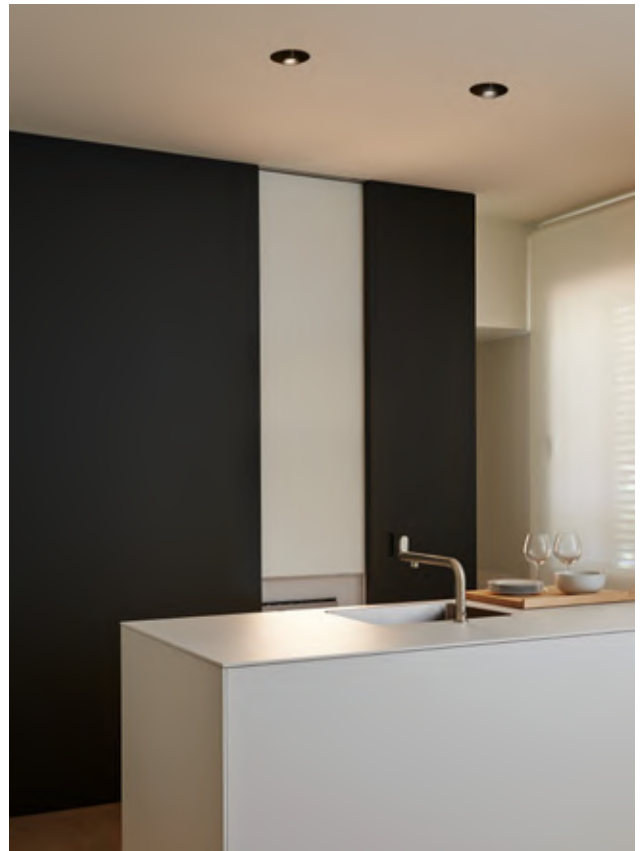

Johnny 80 / Johnny 80 a semi-incasso: sistema di orientamento basculante che consente di estrarre la testa del proiettore per un corretto posizionamento.

Johnny 80 / Johnny 80 Semi-recessed: with the tilt orientation system the spotlight head can be pulled and tilted in the desired direction.

Box per installazione a semi-incasso. Disponibile in finiture cemento, teak, bianco o nero a seconda delle versioni.

Box for semi-embedded installation. Available with cement, teak, white or black finishes, according to the versions.

SQUARE 80 RECESSED



SQUARE 80 SEMI-RECESSED



Johnny 120 / Johnny 120 a semi-incasso: sistema di orientamento meccanico che consente di estrarre la testa del proiettore per un corretto posizionamento.

Johnny 120 / Johnny 120 Semi-recessed: a mechanic orientation system that enables pulling the head out of the projector for a correct orientation.

Box per installazione a semi-incasso. Disponibile in finiture cemento, teak, bianco o nero a seconda delle versioni.

Box for semi-embedded installation. Available with cement, teak, white or black finishes, according to the versions.

SQUARE 120 RECESSED



SQUARE 120 SEMI-RECESSED

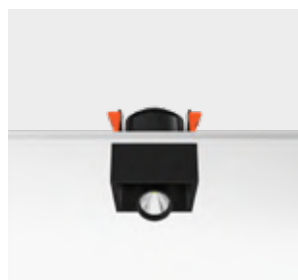



WAN

Designed by Johanna Grawunder

Famiglia di apparecchi di illuminazione la cui forma trae ispirazione dalla cultura giapponese: "wan" infatti significa tazza, intesa nella sua funzione di "contenitore della vita". Due versioni, una spot, dotata di un particolare sistema di orientamento del fascio luminoso, ed una ad incasso. Disponibili con sorgenti luminose alogene o ad alogenuri metallici per adattarsi alle diverse situazioni sia in ambito residenziale che professionale. Disponibile anche con i nuovi LED.

Family of lighting devices whose shape is inspired by the Japanese culture: in fact, "wan" means "cup" but in a figurative sense it is understood as a "life container". Two versions: one spot, equipped with a special beam directional system and a second one for recessed systems. Available with halogen or metal halide lamps to adapt to different situations, either in residential or professional sectors. Also available with the new LED lamp.



SPOT

Find out more at
flos.com/wanspot

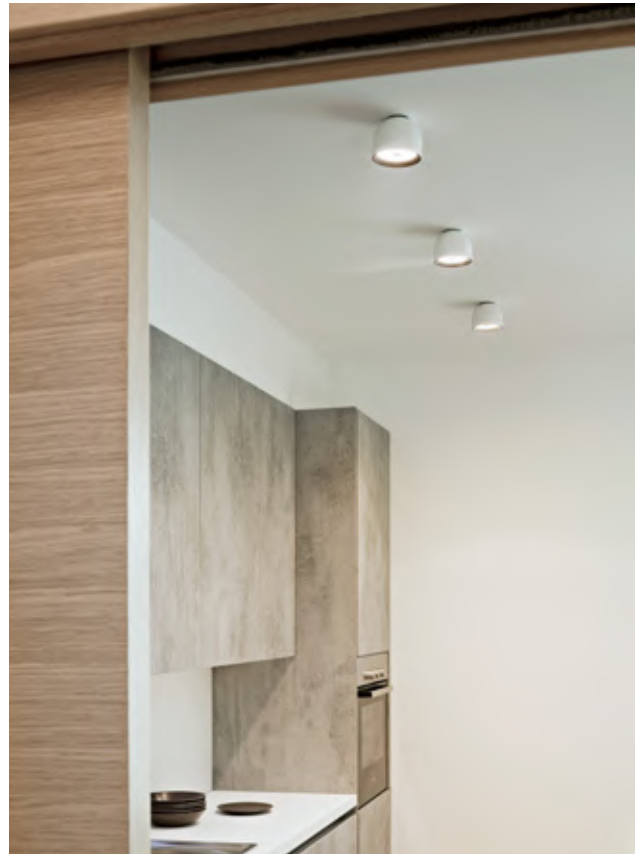

Private House, Italy

DOWNLIGHT

Find out more at
flos.com/wandownlight



Private House, U.K.

G-O

Designed by Jorge Herrera

Apparecchio ad incasso con classe di protezione IP65 per interni. Dotato di LED di ultima generazione, il G-O è appositamente concepito per fungere da segnalazione lungo percorsi o scale. È disponibile con finitura in bianco, alluminio, acciaio inossidabile, bronzo e nero. Il dispositivo ottico può emettere luce bianca calda o ambrata grazie ai diffusori colorati al suo interno.

Recessed luminaire with IP65 protection degree for indoors/outdoors use. Equipped with latest generation LED, G-O is especially designed as bollard lighting for pathways or steps. It is available in white, aluminium, stainless steel, bronze and black finishes. The optical equipment can transmit warm white or amber light thanks to the coloured diffusers on the inside.



Find out more at
flos.com/go



Montenapoleone Vip Lounge, Italy

THEBLOCKOFLIGHT

Designed by Knud Holscher

Apparecchio di segnalazione ad incasso. Ideale per interni/esterni grazie alla sua classe di protezione IP65. Il TheBlockofLight è dotato di un Power LED di ultima generazione e di un diffusore opalino che rende la distribuzione luminosa ottimale.

Recessed signage luminaire. Perfect for indoors/outdoors thanks to its IP65 protection degree. TheBlockofLight has a latest generation Power LED and an opal diffuser for optimal light distribution.



Find out more at
flos.com/theblockoflight





Wall Rupture, Softprofile, Juncos,
Soft Spun, Abajourd'hui, Uso, Uso
Cove Lighting, G-O In, Teardrop,
Round, Square & Vertical Light.

SOFT ARCHITECTURE



UNA NATURALE FUSIONE TRA MATERIA ED ENERGIA, TRA LUCE E ARCHITETTURA
 A NATURAL FUSION OF SUBSTANCE AND ENERGY, BETWEEN LIGHT AND ARCHITECTURE

Amare la luce e l'architettura, fonderle con le soluzioni più creative, ricercando i più avanzati traguardi illuminotecnici e nel totale rispetto dell'ambiente: Flos Soft-Architecture è una nuova filosofia per vivere poeticamente la fusione tra materia ed energia.

Loving light and architecture, melting them in the most creative solutions, looking for the most advanced, lighting and technical aims and fully respecting the environment: Flos Soft-Architecture is the new philosophy to live poetically the fusion of substance and energy.

Rispettare la natura e il suo equilibrio, capirne l'importanza e trarre ispirazione dalla sua perfezione: Flos Soft-Architecture è il frutto di un'approfondita ricerca sull'utilizzo di materiali eco-compatibili e a basso impatto ambientale.

Respecting nature and its balance understanding its value and being inspired by its perfection: Flos Soft-Architecture is the result of an in-depth lighting and technical research on the use of eco-friendly materials with a low impact on the environment.

Unione perfetta di materie ed energia, Flos Soft-Architecture utilizza le più avanzate fonti a risparmio energetico (LED, LED a fosforo remoto, power LED, catodo freddo, fluorescenza compatta, alogeni, IRC/ES) per una perfetta sintesi tra luce, architettura e natura.

Flos Soft-Architecture is a perfect fusion of substance and energy and benefits of the most advanced energy saving sources (LED, Remote Phosphor LED, Power LED, cold cathode, compact fluorescent, halogens, IRC/ES) in order to grant a perfect integration of light, architecture and nature.



1 "Rispetto della Natura e del suo Equilibrio".
 "Respecting Nature and its Balance".

2 Produzione di Soft Architecture.
 Soft Architecture Manufacturing.

3 Ciclo di Vita Sostenibile.
 Sustainable Lifecycle.

4 Riutilizzo senza Impatto Ambientale.
 Relocation with no Environmental Impact.

5 Vendita ed Installazione.
 Sale and Installation.



Nello stabilimento di Flos Architectural, le tecniche tradizionali e le formule avveniristiche si fondono per creare prodotti mai esistiti prima. Grazie a un cartongesso dall'innovativa composizione, la nostra serie Soft Architecture di accessori di illuminazione “senza soluzione di continuità” prende vita nelle mani di esperti artigiani. Soft-Architecture di Flos è un grande esempio di produzione contemporanea, senza sprechi, modellata dagli stessi processi naturali.

In the Flos Architectural factory, traditional techniques and pioneering formulas blend together to create products that have never before existed. Making use of an innovative plaster composition, our Soft Architecture series of seamless lighting appliances comes to life through the hands of skilled local artisans. Flos Soft Architecture is a great example of contemporary, waste-free manufacturing, modelled by nature's very own processes.





WALL RUPTURE

Designed by Thierry Dreyfus

Wall Rupture è un apparecchio invisibile realizzato in Soft Composite. L'effetto è simile a quello di una piega segreta nella parete che nasconde il rilievo irregolare della terra. Disponibile in color oro e argento. È dotato di strisce di LED con varie temperature di colore: 2700K (versione oro) o 5000K (versione argento).

Wall Rupture is an invisible luminaire made of Soft Composite. The effect is like a secret fold in the wall that conceals the irregular relief of the earth. Available in gold and silver. It incorporates LED strips with different colour temperatures: 2700K (gold version) or 5000K (silver version).



Find out more at
flos.com/wallrupture



Expo Valle d'Aosta, Milan



Starhotels E.c.h.o. Hotel,
Italy



SOFTPROFILE SMOOTH

Designed by Flos Soft Architecture

Grazie alla tecnologia Soft Composite, il prodotto si integra perfettamente nello spazio architettonico. La versione Smooth caratterizzata da un profilo liscio, la versione Starck il cui profilo si ispira alla lampada Long & Hard, e la versione Wanders con profilo che si ispira alla lampada Sky Garden. Le tre versioni possono essere installate sia a soffitto che a parete.

Thanks to the Soft Composite technology the profiles become perfectly integrated into the architectural space. There are three versions: the Smooth version characterised by its plain profile, the Starck version whose profile is inspired by the Long & Hard lamp, and the Wanders version with profile inspired by the Sky Garden lamp. All three versions can be ceiling and wall mounted.



Find out more at
flos.com/softprofilessmooth



SOFTPROFILE DECO

Designed by Philippe Starck/Marcel Wanders

DECO STARCK

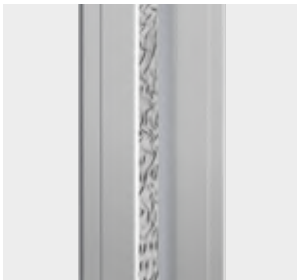

DECO WANDERS



Find out more at
flos.com/softprofiledeco



JUNCOS

Designed by Flos Soft Architecture

Apparecchio di illuminazione ispirato a gruppi di giunchi che spuntano dalla superficie dell'acqua. Con un LED ad alta potenza, il tubo può essere orientato ed inserito o rimosso dal soffitto per dirigere il fascio di luce e creare la composizione desiderata.

Luminaire inspired by 'bunches of reeds' hovering over the water surface. With a high power LED, the tube can be tilted and inserted or removed from the ceiling to direct the beam of light and create the desired artistic composition.

JUNCOS 1L

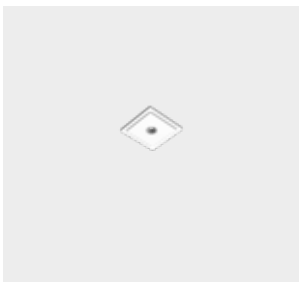

JUNCOS 6L

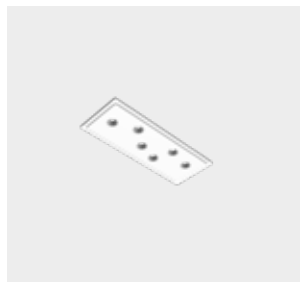

JUNCOS 250 mm



JUNCOS 3L

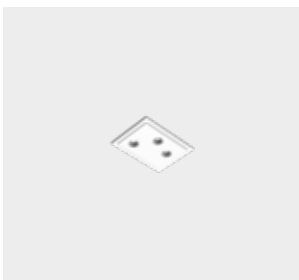

JUNCOS 9L

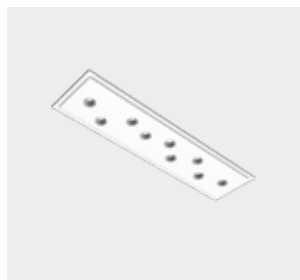

JUNCOS 400 mm



Find out more at
flos.com/juncos



SOFT SPUN

Designed by Sebastian Wrong

Lampada progettata per ridurre al minimo l'impatto visivo, che si installa a semi-incasso su pareti in cartongesso. Disponibile con sorgenti luminose alogene collegate direttamente alla rete, a fluorescenza e a LED. Tutte le versioni sono dotate di vetro di sicurezza opalino.

Lamp designed for minimal visual impact that is flush mounted to plasterboard walls. Available with halogen light sources connected directly to mains, fluorescent and LED lights sources. All of them include opal safety glass.

SMALL

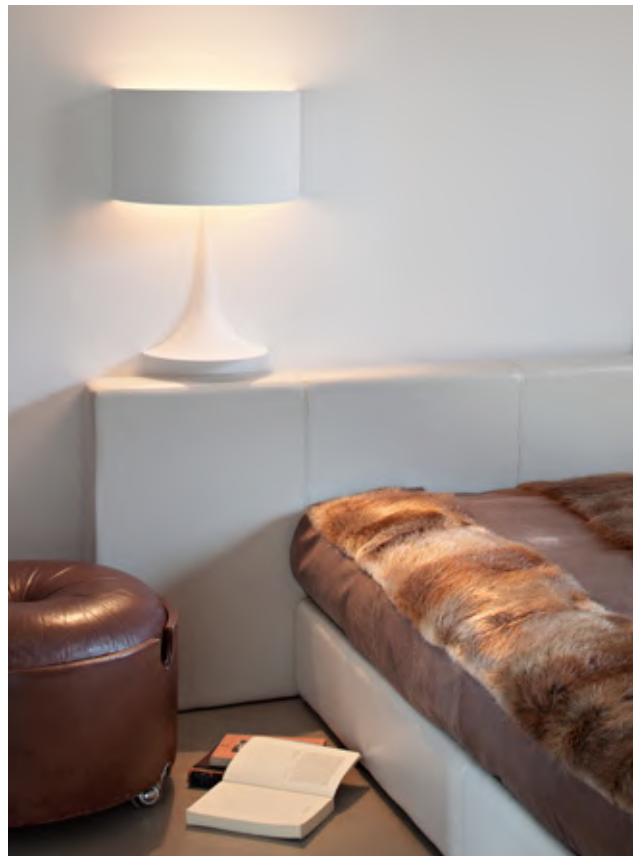

LARGE



Find out more at
flos.com/softspun

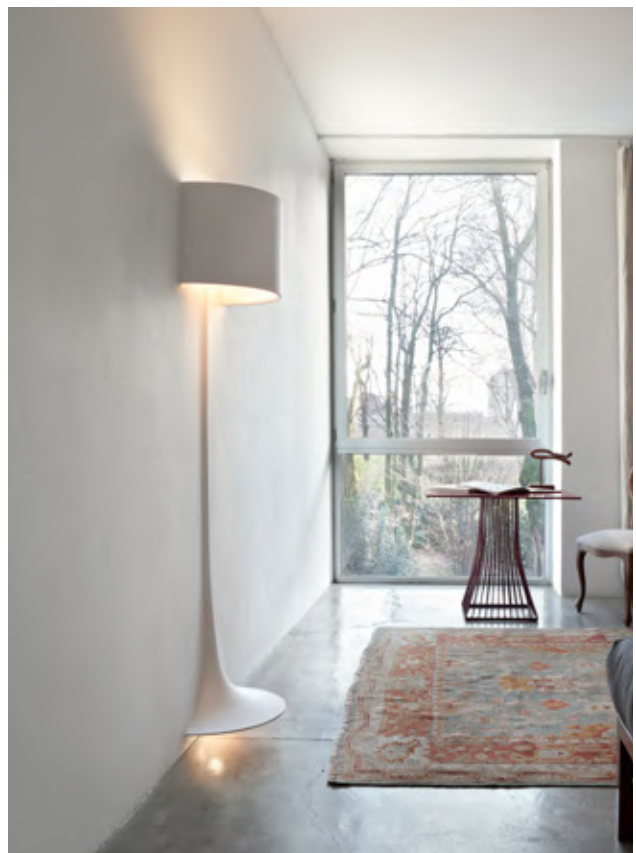



Virgin Active, Portugal



ABAJOUR'HUI

Designed by Flos Soft Architecture

Lampada progettata per ridurre al minimo l'impatto visivo, che si installa a semi-incasso su pareti in cartongesso. Disponibile con sorgenti luminose alogene collegate direttamente alla rete, a fluorescenza e a LED. Tutte le versioni sono dotate di vetro di sicurezza opalino.

Lamp designed for minimal visual impact that is flush mounted to plasterboard walls. Available with halogen light sources connected directly to mains, fluorescent and LED lights sources. All of them include opal safety glass.

SMALL



Verbano Hotel, Italy

LARGE



Find out more at
flos.com/abajourd'hui



Beau Riage Hotel, France



Private House, Geneva

USO

Designed by Flos Soft Architecture

Famiglia di apparecchi realizzati con la tecnologia Soft Composite e ideati per alloggiare i prodotti di FLOS architectural. Disponibile in varie misure e forme oltre che nella versione 1L e 2L, la famiglia Uso offre una grande varietà di soluzioni di illuminazione, garantendo sempre la totale integrazione nello spazio architettonico.

Family of luminaires manufactured with Soft Composite technology and designed to house FLOS architectural project. Available in several sizes and shapes, as well as in 1L and 2L versions, the Uso family offers a wide variety of lighting solutions, always guaranteeing total integration into the architectural space.

USO 332



USO KAP 105/145

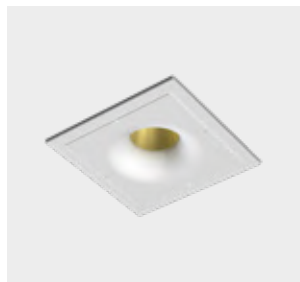

USO 700/800



USO 1000

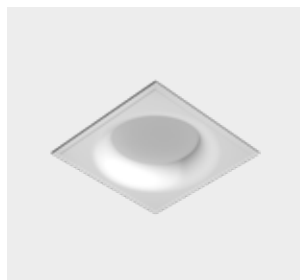

USO 1400



Find out more at
flos.com/uso

USO COVE LIGHTING

Designed by Flos Soft Architecture

Famiglia di apparecchi realizzati con la tecnologia Soft Composite e ideati per alloggiare i prodotti di FLOS architectural. Disponibile in varie misure e forme oltre che nella versione 1L e 2L, la famiglia Uso offre una grande varietà di soluzioni di illuminazione, garantendo sempre la totale integrazione nello spazio architettonico.

Family of luminaires manufactured with Soft Composite technology and designed to house FLOS architectural project. Available in several sizes and shapes, as well as in 1L and 2L versions, the Uso family offers a wide variety of lighting solutions, always guaranteeing total integration into the architectural space.

USO 900 COVE LIGHTING



USO 1700 COVE LIGHTING



USO 2200 COVE LIGHTING



USO 2500 COVE LIGHTING



USO 100 50 COVE LIGHTING



USO 140 90 COVE LIGHTING



Find out more at
flos.com/usocovelighting



G-O IN

Designed by Jorge Herrera

Apparecchio di illuminazione LED da parete, appositamente progettato per la segnalazione di interni come corridoi, scale, ecc. Realizzato con tecnologia Soft Composite, si integra perfettamente nello spazio architettonico. Disponibile in luce bianca, ambra o blu, secondo le esigenze del progetto illuminotecnico.

LED wall luminaire, specifically designed for indoor signage of corridors, stairs, etc. Fitting combined with Soft Composite technology integrates perfectly into the architecture. Available with white, amber or blue light depending on the needs of the lighting project.



Find out more at
flos.com/go/in



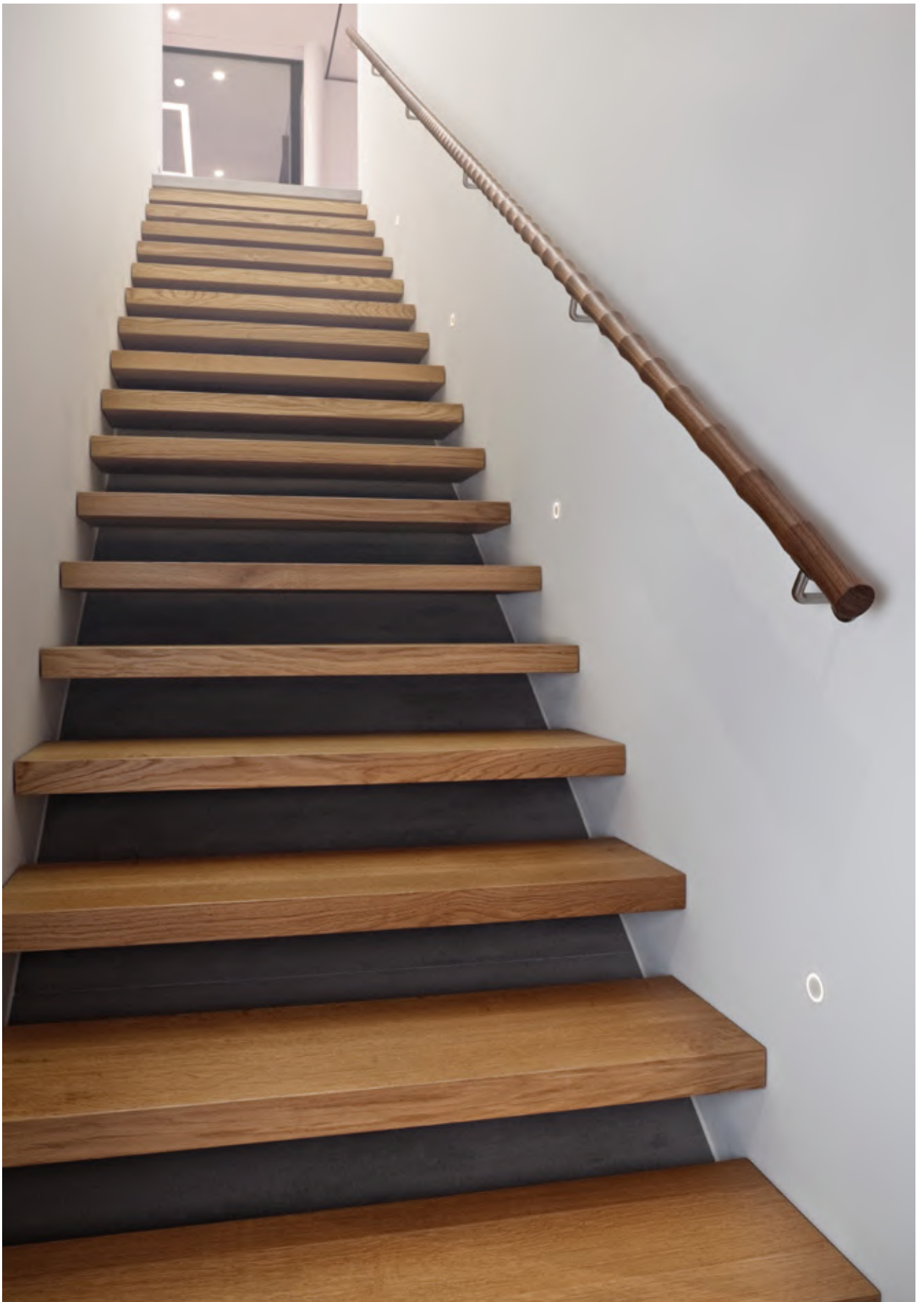

Private House, Holland



TEARDROP

Designed by Calvi Brambilla

Downlight rotondo disponibile in vari diametri progettato per un impatto visivo minimo realizzato con tecnologia Soft Composite. La sorgente luminosa rimane installata in una posizione arretrata, per ottenere un alto comfort visivo. Lastre in cartongesso per installazione a soffitto.

Round downlight available in several diameters designed for minimal visual impact made of plaster. The light source is installed in a deep position, to achieve high visual comfort. Plasterboard ceiling-mounting.

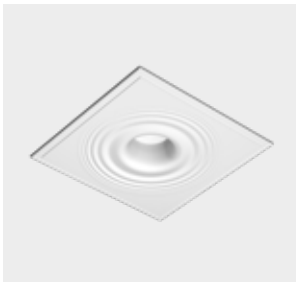

Find out more at
flos.com/teardrop



ROUND, SQUARE & VERTICAL LIGHT

Designed by Flos Soft Architecture

Apparecchio di illuminazione ad incasso per installazione a parete e a soffitto in ambienti interni. Disponibile in versione rotonda/quadrata/rettangolare. Progettato per fondersi con l'ambiente e generare un minimo impatto visivo, la famiglia Round, Square & Vertical Light è dotata di uno schermo integrato al suo interno e di una lente di diffusione in policarbonato.

Recessed light fitting for interior wall and ceiling mounting. Available in round/square/rectangular versions. Designed to blend in with the surroundings and generate minimal visual impact, the Round, Square & Vertical Light family incorporates a screen on the inside as well as diffuser polycarbonate lens.

ROUND



Find out more at
flos.com/roundlight

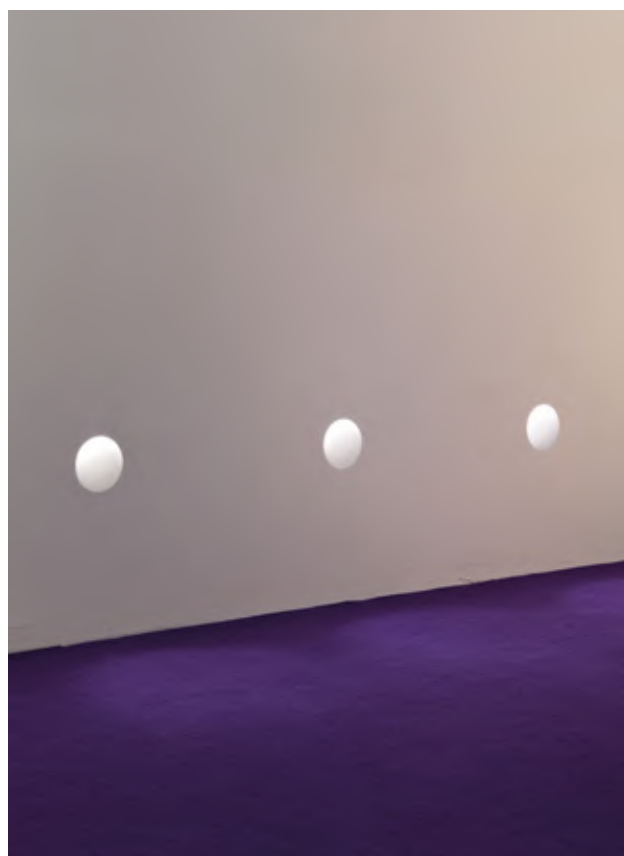

SQUARE



Find out more at flos.com/squarelight



VERTICAL



Find out more at flos.com/verticallight

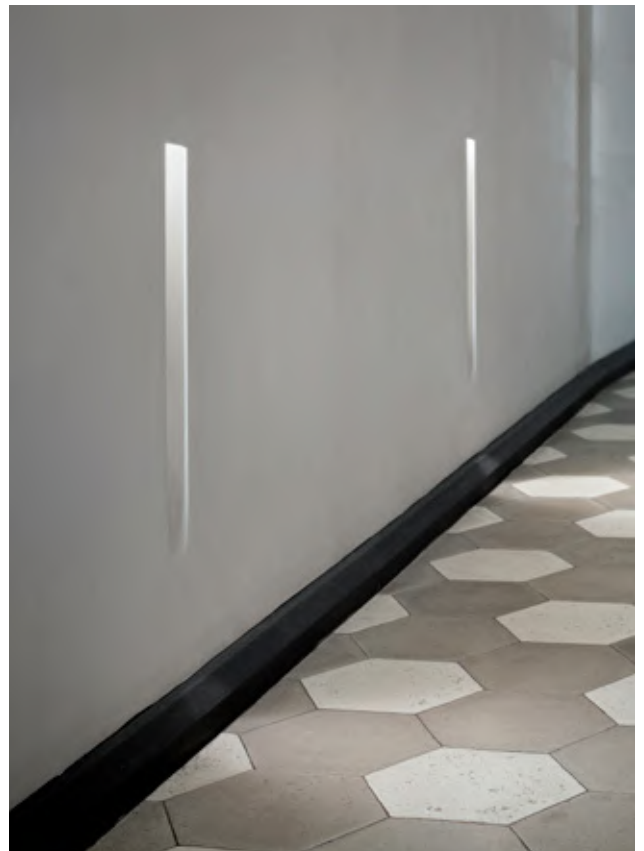

Sempione Cafe, Italy

DISTRIBUTION

**BELGIUM
AND LUXEMBOURG**
Flos Belux
M +32 474 739 080
flosbelux@flos.com

NORWAY
Drammensveien 120
0277 Oslo - Norway
Tel +47 2212 86 00
Fax +47 2212 86 08
info.norge@flos.com

SWEDEN
FLOS Sweden
Lützengatan 1
11520 Stockholm
Sweden
Tel +4686604405
info.se@flos.com

DENMARK
FLOS Scandinavia A/S
Kuglegaardsvej 13-17
1434 Copenhagen K
Denmark
Tel +4533886000
info.dk@flos.com

AMSTERDAM
Cruquiusweg 109S
1019 AG Amsterdam
The Netherlands
Tel +31 (0) 20 560 50 60
flosnetherlands@flos.com

FRANCE
Flos France
20-22, Passage Dauphine
75006 Paris
Tel +33 (0) 1 40 64 17 44
flos.france@flos.com

**AUSTRIA - GERMANY
SWITZERLAND**
Flos GmbH
Obermünsterstraße 18
93047 Regensburg,
Germany
Tel +49 941 630837 00
Fax +49 941 630837 60
info@flos-gmbh.de

UNITED KINGDOM
Atrium Ltd.
28 Leonard Street
EC2A 4BY London
Tel +44 (0) 20 7681 9933
Fax +44 (0) 20 7681 9943
flos@atrium.ltd.uk

UNITED KINGDOM
International Projects
Boccia Giandonato
tel +44(0)20 7681 9933
giandonato.boccia@flos.
com

JAPAN
Flos Japan K.K.
Hulic Aoyama 2nd Bldg 2F
1-3-3 Shibuya Shibuya-ku
Tokyo - Japan
Tel: +81 (0)3 6421 0840
flos.japan@flos.com

ASIA PACIFIC
Flos Representative Office
Antares Iluminacion
Pte Ltd
50 Raffles Place, #30-00
Singapore Land Tower
Singapore 048623
+6590056328
+6591267780

CHINA
Flos Illumination
(Shanghai) Co. Ltd.
Unit 101, Floor 1,
Building B9
No. 800 of Chang De road
Jing An District, Shanghai,
200040, China
Tel +86 021 62176187
floschina@flos.com
(South China)
Tel +86 1392 9975 703
alan.wong@flos.com

LATIN AMERICA
Flos LatAm
M +52 55 6960 1772
flos.latinoamerica@flos.com

INDIA
Flos Representative Office
1, Commonwealth Lane
#08-12, 149544 Singapore
Tel +91 9999306667
Fax +65 (0) 6372 7607
flosindia@flos.com

U.S.A.
Flos USA Inc.
40-20 22nd Street -
3rd Floor
Long Island City, NY 11101
Tel +1 (800) 841 4011
info@flosusa.com

MIDDLE EAST
Antares Iluminacion S.A.
Dubai Design District
Building 1B, Office 303
P.O.Box number 333025
Dubai, United Arab
Emirates
Tel: +971 4 566 0123
Mob: +971 543567356

HONG KONG
M +852 9307 3713
flosasia@flos.com

SHOWROOMS

STOCKHOLM
FLOS Sweden
Lützengatan 1
11520 Stockholm
Sweden
Tel +4686604405
info.se@flos.com

COPENHAGEN
FLOS Scandinavia A/S
Kuglegaardsvej 13-17
1434 Copenhagen K
Denmark
Tel +4533886000
info.dk@flos.com

AMSTERDAM
Cruquiusweg 109S
1019 AG Amsterdam
The Netherlands
Tel +31 (0) 20 560 50 60
showroom.amsterdam@
flos.com

OSLO
Drammensveien 120
0277 Oslo - Norway
Tel +47 (0) 2212 86 00
Fax +47 (0) 2212 86 08
info.norge@flos.com

MILANO
Corso Monforte, 15
20122 Milano
Tel +39 02 79 84 57
Fax +39 02 89 78 56 41
showroom.milan@flos.com

PARIS
20-22, Passage Dauphine
75006 Paris
Tel +33 (0) 1 40 64 17 44
flos.france@flos.com

TOKYO
PMC Building 8F
1-23-5 Higashiazabu
Minato-Ku
Tokyo 104-0044
Tel: +81 (0)3 3582 1468
Fax: +81 (0)3 3582 0974
showroom.tokyo@flos.com

FLAGSHIP STORES

MILANO
Corso Monforte, 9
20122 - Milano
Tel +39 02 37011080
Fax +39 02 780833
shop.milan@flos.com

ROMA
Via del Babuino, 85
00187 - Roma
Tel +39 06 3207631
Fax +39 06 3207690
flosroma@flos.com

NEW YORK
135 Madison Ave
New York, NY 10016
Tel +1 212 941 4760
Fax +1 212 941 4763
info@flosusa.com

PARIS
15, Rue de Bourgogne
75007 - Paris
Tel +33 (0) 1 53 85 49 93
Fax +33 (0) 1 53 85 49 99
flosparis@flos.com

LYON
17 Rue Jarente
69002 - Lyon
Tel +33 478621301
Fax +33 478622119
floslyon@flos.com

STOCKHOLM
FLOS Sverige
Lützengatan 1
11520 Stockholm
Sweden
Tel +46086604405
info.se@flos.com

CONTACT

ITALY

Flos Spa
Via Angelo Faini, 2
25073 Bovezzo (Brescia)
Tel +39 0302438.1
Fax +39 0302438.250
info@flos.com

SPAIN

Antares Iluminación S.A.U.
Calle Mallorca, 1
Polígono Industrial Reva
46394 Ribarroja (Valencia)
Tel +34 96 166 95 20
Fax +34 96 166 82 86
flos.architectural@flos.com

IN-PLACE
PHOTOGRAPHY

Adam Letch
Adrian Houston
Aleš Jungmann
Alexandros Pissourios
Anarchitect I
Andrew Krucko
Andrew Latreille
Andy Spain
Andy Stagg
Ángel Rosique
Photography
B2Ai – fotograaf Bart
Heijmans
Beeldpunt
Bernard Andre
BIS images
Bouroullec Studio
Boys Plays Nice
Brian W. Ferry
Bruno Rondinelli
C. Taylor Crothers (CTC)
Celine de Gussem
Cesare Chimenti
Chiel de Nooyer
Clarysse Valerie, HC
Connie Zhou
CTC Creative
David Frutos
Diana di Nitto
EK Yap Creative &
Photography
Erlantz Biderbost
Eugeni Pons
Fabio Gambina
Federica Cartlet
Federico Torra
Fernando Alda
Francesco Caredda
Fraser Marsden
Frederik Vercrusse
Germán Cabo
Germano Borrelli
Gionata Xerra
Héctor Santos
Jabali Studio
Javier Bravo
Javier Márquez
Javier Orive

Jesús Granada
Joao Morgado
Julian Walter
Killian O'Sullivan
Kris Dekeijser
LevaSaudargaite
Liesbeth Goudenhoof
Lindman Photography AB
Mariela Apollonio
Matt Chisnall
Mattia Greggi
MaxRommel
MCM and The Estee
Lauder Companies UK &
Ireland
Michel Giesbrecht &
Studio Bouroullec
Moriq interiors and Design
Consultans
Olivier Baco
Omar Sartor
Pere Peris
Petra Kleis
Pia Riverola
PIAGGIO Fast Forward
RBA / Eugeni Pons
RBA ImagesBIS images
Roland Halbe
Rubén P. Bescós
Santi Caleca
Schwarz – Licht
Shuhe
Simona Rota
Simone Bossi
Studio Moost / Studio
Tomorrow
Tamas Bujnovszky / BE
LIGHT!
Tommaso Sartori
Valerie Clarysse / Beelpunt
Photography
Victoria Muñoz
VIEW / Andy Stagg
VIEW / Ed Reeve
VIEW / Francesco Russo
Volker Conradus
Woo-Jin Park

CREDITS

ART DIRECTION
Apartamento Studios

GRAPHIC DESIGN
Apartamento Studios

PHOTO INTEGRATION
Mozing Studio
Jorge Herrera Studio

PHOTO PRODUCT
Piero Fasanotto
Alessandro Lourenço

LAYOUT
Flos Architectural Team

PRODUCT INFORMATION
UPDATE
14-05-2024

EDITION
14-05-2024
Copyright © Flos 2024
All rights reserved

ACKNOWLEDGEMENTS

05AM Arqtes	Issey Miyake	United Nations
Alex March	Itínere Baqueira	Val Office
Alfons & Damian	Jorge Herrera	Versace
Anarchitect	Kitoko	Viccarbe
Andreu World	Klaarchitectuur Offices	Víctor Bergnes
AntwerpPhoto	Kvadrat	Victoria Beckham
Arassociati	Lardini	VIEW Pictures Ltd / Alamy
Archiproducts	Lighting Workshop	Vincent Van Duysen Studio
Arclinea	Lightpoint	Vincenzo De Cotiis
Axiom Consulting Partners	Lissoni & Partners	Architects
Babel Studio	LOFT4C	Virgin Active
Barbara Balestreri	Lukas Lighting	Voltaire
BassamFellows Inc.	Luminae Lighting Design	White Houses
Beeldpunt	Marco Costanzi Architets	Zusa
B&B Italia	Marcos Catalán	
Bombas Gens	Maxime De Campenaer	
Bombi/Gómez	MCM	
Boubau	MLD	
Boys Plays Nice	Moba Showroom	
Budapest	Mobitec	
BURO B	Molteni	
Carbonado Energy	Moremas Arquitectos	
Carhartt	Mount Sinai Hospital	
Central European	Natixis	
University	Negre Estudio	
Claudio Castellini	O'Donnell + Tuomey Ltd.,	
Conran and Partners	Palazzo Reale Milano	
Cosín Showroom	Park 51	
COULON & Ass	Peia Associati	
Curiosity	Pepe Cabrera	
De Witte Duif	Piaggio Fast Forward	
Emilio Nanni	Pitsou Kedem	
Estee Lauder	Poliform	
EstudiHac	Porcelanosa	
Estudio Querencia	RBA / Eugeni Pons	
Fabio Fantolino	Renzo Piano	
Familia Parrón-Ortiz	RF Dubai	
Fantini	Ricardo de Landaluce	
Fogarty Finger	RNB	
Fran Silvestre	Roberto Falconi - Falconi	
Francesco Caredda	Architettura	
Franco Scaglia	Ronan & Erwan Bouroullec	
Gandía Blasco	Rossano Ferretti	
Gomarco	Sergio Rossi	
Gyro Toys	Studio Civico 46	
Hakei	Studio Tronconi Architetti	
Hans Abaton	Teampannon Kft	
IN56 Interiorismo	The Conran Shop & APT	
INC Architecture & Design	Design	
PLLC	The KaDeWe Group	
Iñigo Beguiristain	TPG Architecture	

Il nostro mondo si evolve continuamente. I progressi tecnici sono all'ordine del giorno nel nostro settore.

As our world is in constant evolution, technical upgrades happens every day in our business.

Lo scopo di Flos è offrire sempre la tecnologia più affidabile a disposizione, rivedendo continuamente i prodotti e aggiornandoli non appena le evoluzioni tecnologiche offrono vantaggi per i nostri partner e clienti.

Flos aim is to offer always the best reliable technology available, constantly reviewing our products and upgrading them as soon as technologic evolutions offers benefits for our partners and clients.

Questa filosofia fa sì che il nostro catalogo e le schede tecniche dei nostri prodotti siano anch'essi in continua evoluzione, con la conseguente necessità di aggiornamenti e revisioni continue.

This philosophy means that our technical catalogue and product data sheets also are in constant evolution, requiring upgrades and constants reviewing.

Per tanto, quando avete bisogno di dettagli tecnici e delle informazioni più recenti, sfogliate la sezione prodotti del nostro sito Web ufficiale Flos.com: è aggiornato quotidianamente e offre gli ultimi dettagli dei prodotti, dei codici degli articoli disponibili e tutta la documentazione per il download immediato.

Thus, when you need technical details and the most recent product information, please browse the product section of our Flos.com official website: it is updated daily, and there you'll find the latest product details, all available part numbers, all product documents available for immediate download.

www.flos.com

www.flos.com

THE RUNNING MAGNET, THE TRACKING MAGNET,
THE TRACKING POWER EVO, THE FAST TRACK,
IN-FINITY, LIGHT CUT MINI, GUSTAVE, EMI, OBLIQUE,
OBLIQUE FLOOR, WORKMATES, LIGHT SHADOW,
LIGHT SHADOW DOTS, LIGHT SHADOW PRO,
ECLECTIC, CIRCLE OF LIGHT, LED CURTAIN, KAP,
BON JOUR, UT DOWNLIGHT, LIGHT SUPPLY, WAN
DOWNLIGHT, JOHNNY, LIGHT SHADOW SPOT,
CAMERA, FIND ME, UT SPOT, WAN SPOT, C1, UT
PRO SURFACE, KAP SURFACE, SUPER LINE, SUPER
LINE PRO, SUPER FLAT, LIGHT BELL, FORT KNOX
WALL, THIN LED, G-O, THEBLOCKOFFLIGHT, WALL
RUPTURE, SOFTPROFILE, JUNCOS, SOFT SPUN,
ABAJOURD'HUI, G-O IN, TEARDROP, USO, USO COVE
LIGHTING, ROUND, SQUARE & VERTICAL LIGHT.